

PLC Connection Guide

AIBUS	2	DELTA DVP	61
Allen-Bradley CompactLogix/FlexLogix.....	5	Embedded PC (BECKHOFF).....	63
Allen-Bradley DF1.....	9	EMERSON PLC EC20	71
Allen-Bradley DF1 (BCC).....	12	F930GOT Server.....	73
Allen-Bradley DH485.....	15	FATEK FB Series.....	76
Allen-Bradley EtherNet/IP (CompactLogix).....	19	Fuji NB Series	79
Allen-Bradley EtherNet/IP (CompactLogix) – Free Tag Names.....	22	GE Fanuc CMM	81
Allen-Bradley EtherNet/IP (ControlLogix) – Free Tag Names.....	26	GE Fanuc RX3i	84
Allen-Bradley EtherNet/IP (DF1)	30	GE Fanuc Series 90-30 (Ethernet).....	86
Allen-Bradley PLC5.....	33	GE Fanuc SNP-X.....	89
Altus ALNET-I	37	HanYoung Series	92
Baumuller.....	40	Heng Yuan Sensor.....	94
Change	42	HITACHI EH-SIO	96
Cimon CM1-CP4A/ECO1A	44	HITACHI EHV Series (Ethernet)	99
Cimon CM1-SC02A.....	46	HITACHI H/EH/EHV Series.....	101
Copley Controls	48	HUST H4X	106
CROUZET M3 (FBD).....	50	IAI X-SEL CONTROLLER.....	108
CROUZET M3 (LAD)	52	IDEC Micro.....	111
Danfoss ECL Apex20.....	55	INOVANCE H2U/H1U	114
Danfoss FC Series	57	Intelligent Servo	116
Danfoss VLT2800 Series	59	Justfi controller	118
		Kernel sistemi.....	120

KEYENCE KV-10/16/24/40/80/Visual KV Series	122	MITSUBISHI A2US	181
KEYENCE KV-5000 (Ethernet)	124	MITSUBISHI A3N/A1SH	184
KEYENCE KV-700/1000/3000/5000 Series	126	MITSUBISHI AJ71	187
Korenix 6550	128	MITSUBISHI FX0n/FX2.....	189
Koyo CLICK	130	MITSUBISHI FX232/485BD	191
KOYO DIRECT	132	MITSUBISHI FX2n	194
Koyo Ethernet	137	MITSUBISHI FX3u (Ethernet)	196
Lenze	139	MITSUBISHI FX3u/FX3G.....	203
LIYAN EX series	141	MITSUBISHI MELSEC-Q (Ethernet)	205
LS GLOFA Cnet.....	143	MITSUBISHI Q00/Q00UJ/Q01/QJ71	210
LS GLOFA GM3467 (LOADER).....	146	MITSUBISHI Q00J	215
LS MASTER-K Cnet.....	148	MITSUBISHI Q00U/Q01U/Q02U/QnUD/QnUDH	217
LS MASTER-K10S1.....	150	MITSUBISHI Q00UJ/QnU/QnUD/QnUDH/QnUDEH (mini USB).....	219
LS MASTER-K300S CPU	152	MITSUBISHI Q02/02H	221
LS XGB/XGT.....	154	MITSUBISHI Q06H	223
LS XGB/XGT FEnet (Ethernet)	156	MITSUBISHI QJ71E71 (Ethernet).....	225
LS XGL-CH2A Cnet	159	MODBUS ASCII	233
LS XGL-EFMT FEnet (Ethernet)	161	MODBUS RTU	236
LS XGT/XGK CPU DIRECT	163	MODBUS RTU (0x/1x Range Adjustable).....	240
Master (Master-Slave Protocol)	165	MODBUS RTU (zero-based addressing)	248
Memobus (Yaskawa MP Series Controllers).....	168	MODBUS Server (Modbus RTU Slave).....	252
Memory Map	173	MODBUS TCP/IP (Ethernet).....	255
MITSUBISHI A1S.....	175	MODBUS TCP/IP (zero-based addressing)	257
MITSUBISHI A2A.....	178		

MODBUS TCP/IP 32Bit.....	259	SIEMENS S7/200 (Ethernet).....	328
Moeller XC-CPU101.....	261	SIEMENS S7/300.....	330
Modicon Twido.....	263	SIEMENS S7/300 (Ethernet).....	333
OEMAX Series.....	265	SIEMENS S7/300 MPI.....	335
OMRON C/CQM1 Series.....	267	SIEMENS S7/400 (Ethernet).....	337
OMRON CJ/CS/CP.....	270	SIMATIC TI505.....	342
OMRON CJ1/CS1 (Ethernet).....	273	TAIAN TP02 Series.....	345
OMRON E5CN.....	276	TAIAN TP03 Series.....	347
Panasonic FP.....	278	TECO Inverter.....	349
Panasonic FP (Ethernet).....	282	TELEMECANIQUE UniTelway.....	351
Panasonic FP2 (Ethernet).....	285	Topvert.....	353
Panasonic MINAS A4.....	287	Toshiba T Series.....	355
Parker ACR9000.....	291	Toshiba TC mini Series.....	358
Parker Compax3.....	293	Toshiba VF-S11.....	360
Parker SLVD Series.....	297	VIGOR.....	362
SAIA PCD PGU Mode.....	299	YAMAHA ERCD.....	364
SAIA PCD S-BUS Mode.....	301	YASKAWA MP Series Ethernet (Extension).....	367
SAIA S-BUS (Ethernet).....	311	YASKAWA SMC 3010.....	371
Schleicher XCS 20C.....	314	YASKAWA SMC 3010 (Ethernet).....	374
Schleicher XCX 300.....	316	Yokogawa FA-M3.....	378
SEW Movilink.....	319	Yokogawa FA-M3 (Ethernet).....	384
SIEMENS S7/1200 (Ethernet).....	321	MT6050i/MT8050i Com Port Pin Assignment.....	386
SIEMENS S7/200.....	326		

AIBUS

Supported series: UDIAN Automation AI-501, AI-518, AI-519, AI-701, AI-702M, AI-704M, AI-706M, AI-719.

Website: <http://www.yudian.us>

HMI Setting:

Parameters	Recommend	Option	Notes
PLC type	AIBUS		
PLC I/F	RS485 2W	RS232	
Baud rate	9600	9600, 19200	
Parity	None		
Data bits	8		
Stop bits	2		
HMI st. no.	0		
PLC st. no.	1	0-100	

On-line simulation	YES	
Extend address mode	NO	

Device Address:

AI-518

Bit/Word	Device type		Format	Range	Memo
W	0	00H	DD		SV/STEP
W	1	01H	DD	-1999 ~ 9999	HAL
W	2	02H	DD	-1999 ~ 9999	LoAL
W	3	03H	DD	0 ~ 9999	dHAL
W	4	04H	DD	0 ~ 9999	dLAL
W	5	05H	DD	0 ~ 2000	dF
W	6	06H	DD	0 ~ 4	Ctrl
W	7	07H	DD	0 ~ 9999	M5
W	8	08H	DD	1 ~ 9999	P
W	9	09H	DD	0 ~ 2000	t
W	10	0AH	DD	0 ~ 125	Ctl
W	11	0BH	DD	0 ~ 37	Sn (read only)
W	12	0CH	DD	0 ~ 3	dIP (read only)

W	13	0DH	DD	-1999 ~ 9999	dIL
W	14	0EH	DD	-1999 ~ 9999	dIH
W	15	0FH	DD	0 ~ 9999	ALP
W	16	10H	DD	-1999 ~ 4000 0.1□	Sc
W	17	11H	DD	0 ~ 48	Op1
W	18	12H	DD	-110 ~ 110%	oPL
W	19	13H	DD	0 ~ 110%	oPH
W	20	14H	DD	0 ~ 127	CF (read only)
W	21	15H	DD	0 ~ 19.2K	Baud rate (bAud) /808Pstatus word: run: 0 suspend: 4 stop: 12 (read only)
W	22	16H	DD	0 ~ 100	ADDR
W	23	17H	DD	0 ~ 20	dL
W	24	18H	DD	0 ~ 127	Run
W	25	19H	DD	0 ~ 9999	Loc

AI-701

Bit/Word	Device type		Format	Range	Memo
W	1	01H	DD	-9990 ~ 30000	HIAL
W	2	02H	DD	-9990 ~ 30000	LoAL
W	3	03H	DD	-9990 ~ 30000	HdAL
W	4	04H	DD	-9990 ~ 30000	LdAL
W	5	05H	DD	0 ~ 2000	AHYS
W	11	0BH	DD	0 ~ 37	InP (read only)
W	12	0CH	DD	0 ~ 3	dPt
W	13	0DH	DD	-9999 ~ 30000	SCL
W	14	0EH	DD	-9999 ~ 30000	SCH
W	15	0FH	DD	0 ~ 4444	AOP
W	16	10H	DD	-1999 ~ 4000 0.1□	Scb
W	17	11H	DD	0 ~ 48	Opt
W	21	15H	DD	0 ~ 19.2K	Baud rate (bAud)

					/808P status word run: 0 suspend: 4 stop: 12 (read only)
W	22	16H	DD	0 ~ 80	ADDR
W	23	17H	DD	0 ~ 40	FILt
W	25	19H	DD	0 ~ 255	Loc

Wiring Diagram:

HMI COM1 RS485 2W 9P D-Sub Female	HMI COM3 RS485 2W 9P D-Sub Female		RS485 2W Port
1 RX-	6 Data-		4 COMM A
2 RX+	9 Data+		3 COMM B
5 GND	5 GND		
			

Driver Version:

Version	Date	Description
V1.20	Dec/30/2008	

Allen-Bradley CompactLogix/FlexLogix

Supported series: Allen-Bradley ControlLogix, CompactLogix, FlexLogix CH0 DF1.

Website: <http://www.ab.com>

HMI Setting:

Parameters	Recommend	Option	Notes
PLC type	Allen-Bradley CompactLogix/FlexLogix		
PLC I/F	RS232		
Baud rate	19200	9600, 19200, 38400	
Parity	None	Even, Odd, None	
Data bits	8	8	
Stop bits	1	1	
HMI st. no.	0		
PLC st. no.	1	1-31	

PLC Setting:

Communication mode	DF1 Full Duplex protocol 19200, None, 8, 1 (default) Error Check: BCC, Station Address: 1
--------------------	--



ControlLogix, CompactLogix CPU CH0 setting:

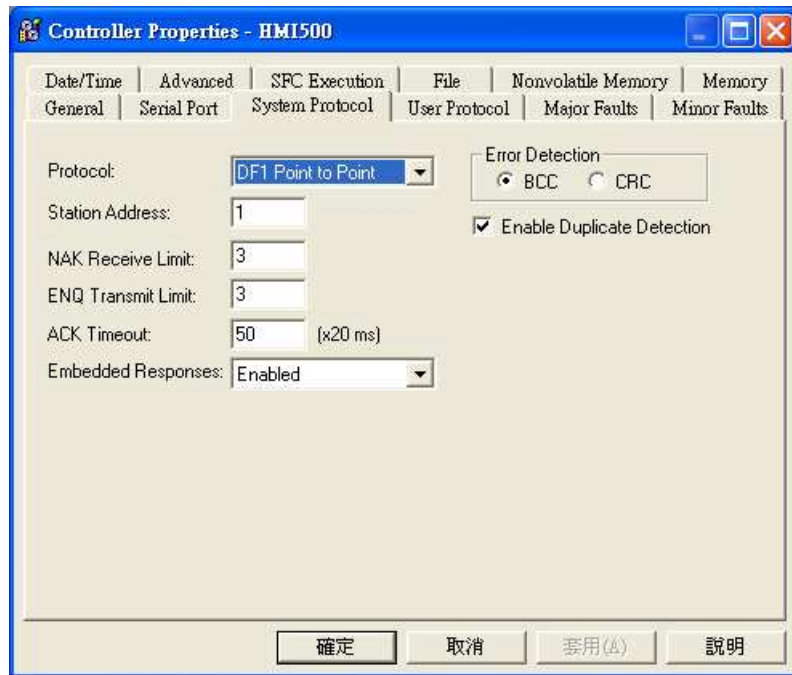

Create the Tag:

The name format must use 4 chars like B003, T004, C005, N007, and F008.

Two or three chars are not available. For example: B03 or B3.

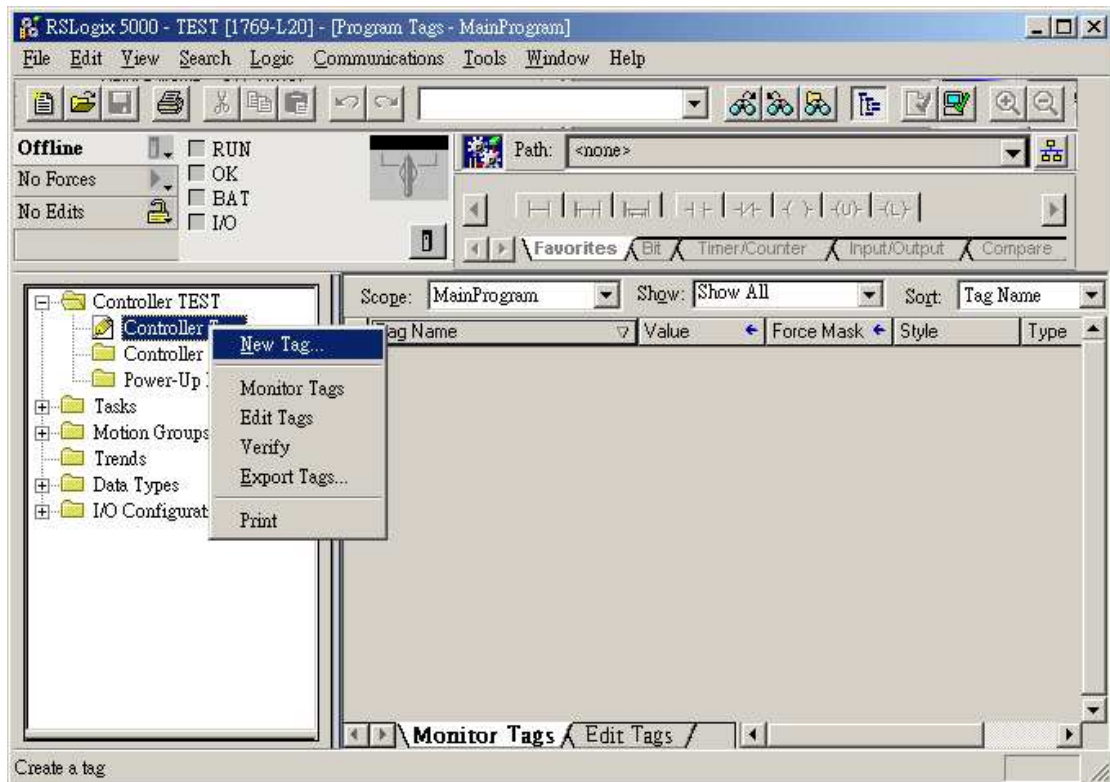

New Tag

Name: B003

Description:

Tag Type:

- Base
- Alias
- Produced 2 consumers
- Consumed

Data Type: INT[255] Configure...

Scope: TEST(controller)

Style: Decimal

Buttons: OK, Cancel, Help

Select Data Type

Data Types:

INT[255]

- FBD_TIMER
- FBD_TRUNCATE
- FILTER_HIGH_PASS
- FILTER_LOW_PASS
- FILTER_NOTCH
- FLIP_FLOP_D
- FLIP_FLOP_JK
- FUNCTION_GENERATOR
- HL_LIMIT
- INT
- INTEGRATOR

Array Dimensions:

Dim 0: 255 Dim 1: 0 Dim 2: 0

Buttons: OK, Cancel, Help

Device Address:

Bit/Word	Device type	Format	Range	Memo
B	B_BOOL	FFFDDDD	0 ~ 25525515	Bit data file
B	N_BOOL	FFFDDDD	0 ~ 25525515	Integer data file bit level (N7, 10~255)
W	Bx_INT	FFFDDD	0 ~ 255255	Bit data file word level
DW	Tx.PRE	FFFDDD	0 ~ 255255	Timer Preset Value (T4, T10~255)
DW	Tx.ACC	FFFDDD	0 ~ 255255	Timer Accumulator Value (T4, T10~255)
DW	Cx.PRE	FFFDDD	0 ~ 255255	Counter Preset Value (C5,

				C10~255)
DW	Cx.ACC	FFFDDD	0 ~ 255255	Counter Accumulator Value (C5, C10~255)
W	F8_REAL	DDD	0 ~ 255	Floating point data file (F8)
W	Fx_REAL	FFFDDD	0 ~ 255255	Floating point data file (F008, F010~F255)
DW	Nx_INT	FFFDDD	0 ~ 255255	Integer data file (N7, 10~255)

Wiring Diagram:

HMI COM1 RS232 9P D-Sub Male	HMI COM2 RS232 9P D-Sub Male	HMI COM3 RS232 9P D-Sub Female	AB CPU CH0 RS232 9P D-Sub Male
2 RX	6 RX	8 RX	3 TD
3 TX	4 TX	7 TX	2 RD
5 GND	5 GND	5 GND	5 GND



Driver Version:

Version	Date	Description
V1.20	Dec/30/2008	

Allen-Bradley DF1

Supported series: Allen-Bradley MicroLogix 1000, 1100, 1200, 1400, 1500, SLC 5/03, 5/04, 5/05.

Website: <http://www.ab.com>

Note: Allen-Bradley DF1 driver is used CRC checksum.

HMI Setting:

Parameters	Recommend	Option	Notes
PLC type	Allen-Bradley DF1		
PLC I/F	RS232		
Baud rate	9600	9600, 19200, 38400	
Parity	None	Even, Odd, None	
Data bits	8	8	
Stop bits	1	1	
HMI st. no.	0		
PLC st. no.	1	1-31	

PLC Setting:

Communication mode	DF1 Full Duplex protocol 19200, None, 8, 1 (default) Error Check: CRC
--------------------	--

Device Address:

Bit/Word	Device type	Format	Range	Memo
B	I1	DDDdd	0 ~ 25515	Input (I)
B	O0	DDDdd	0 ~ 25515	Output (O)
B	S_Bit	DDDdd	0 ~ 25515	Status (S) bit level
B	B3	DDDdd	0 ~ 25515	Bit data file (B3)
B	B10~13	DDDdd	0 ~ 25515	Bit data file (B10~13)
B	Bfn	FFFDDDDdd	0 ~ 25525515	Bit data file (B3, 10~254)
B	NfnBit	FFFDDDDdd	0 ~ 25525515	Integer data file bit level (N7, 10~254)
W	S	DDD	0 ~ 255	Status (S)
W	T4SV	DDD	0 ~ 255	Timer Preset Value (T4)
W	TfnSV	FFFDDD	0 ~ 255255	Timer Preset Value
W	T4PV	DDD	0 ~ 255	Timer Accumulator Value (T4)

Bit/Word	Device type	Format	Range	Memo
W	TfnPV	FFFDDD	0 ~ 255255	Timer Accumulator Value
W	C5SV	DDD	0 ~ 255	Counter Preset Value (C5)
W	CfnSV	FFFDDD	0 ~ 255255	Counter Preset Value
W	C5PV	DDD	0 ~ 255	Counter Accumulator Value (C5)
W	CfnPV	FFFDDD	0 ~ 255255	Counter Accumulator Value
W	N7	DDD	0 ~ 255	Integer data file (N7)
W	N10~15	DDD	0 ~ 255	Integer data file (N10~15)
W	F8	DDD	0 ~ 255	Floating point data file (F8)
W	Nfn	FFFDDD	0 ~ 255255	Integer data file (N7, 10~254)
W	Ffn	FFFDDD	0 ~ 255255	
W	Lfn	FFFDDD	0 ~ 255255	

Wiring Diagram:

9P D-Sub to 8P Mini-DIN: MicroLogix 1000, 1100, 1200, 1400, 1500

HMI COM1 RS232 9P D-Sub Male	HMI COM2 RS232 9P D-Sub Male	HMI COM3 RS232 9P D-Sub Female	MicroLogix RS232 8P Mini-DIN
2 RX	6 RX	8 RX	7 TXD
3 TX	4 TX	7 TX	4 RXD
5 GND	5 GND	5 GND	8 GND



9P D-Sub to 9P D-Sub: SLC5/03, 04, 05 CH0

HMI COM1 RS232 9P D-Sub Male	HMI COM2 RS232 9P D-Sub Male	HMI COM3 RS232 9P D-Sub Female	AB CPU CH0 RS232 9P D-Sub Male
2 RX	6 RX	8 RX	3 TD
3 TX	4 TX	7 TX	2 RD
5 GND	5 GND	5 GND	5 GND



Driver Version:

Version	Date	Description
V2.20	Jan/05/2010	

Allen-Bradley DF1 (BCC)

Supported series: Allen-Bradley MicroLogix 1000, 1100, 1200, 1500, SLC 5/03, 5/04, 5/05.

Website: <http://www.ab.com>

Note: Allen-Bradley DF1 (BCC) is the same as Allen-Bradley DF1, and the only different is this driver uses BCC checksum.

HMI Setting:

Parameters	Recommend	Option	Notes
PLC type	Allen-Bradley DF1 (BCC)		
PLC I/F	RS232		
Baud rate	19200	9600, 19200, 38400	
Parity	None	Even, Odd, None	
Data bits	8	8	
Stop bits	1	1	
HMI st. no.	0		
PLC st. no.	1	1-31	

PLC Setting:

Communication mode	DF1 Full Duplex protocol 19200, None, 8, 1 (default) Error Check: CRC
--------------------	--

Device Address:

Bit/Word	Device type	Format	Range	Memo
B	I1	DDDdd	0 ~ 25515	Input (I)
B	O0	DDDdd	0 ~ 25515	Output (O)
B	S_Bit	DDDdd	0 ~ 25515	Status (S) bit level
B	B3	DDDdd	0 ~ 25515	Bit data file (B3)
B	B10~13	DDDdd	0 ~ 25515	Bit data file (B10~13)
B	Bfn	FFFDDDdd	0 ~ 25525515	Bit data file (B3, 10~254)
B	NfnBit	FFFDDDdd	0 ~ 25525515	Integer data file bit level (N7, 10~254)
W	S	DDD	0 ~ 255	Status (S)
W	T4SV	DDD	0 ~ 255	Timer Preset Value (T4)
W	TfnSV	FFFDDD	0 ~ 255255	Timer Preset Value
W	T4PV	DDD	0 ~ 255	Timer Accumulator Value (T4)

Bit/Word	Device type	Format	Range	Memo
W	TfnPV	FFFDDD	0 ~ 255255	Timer Accumulator Value
W	C5SV	DDD	0 ~ 255	Counter Preset Value (C5)
W	CfnSV	FFFDDD	0 ~ 255255	Counter Preset Value
W	C5PV	DDD	0 ~ 255	Counter Accumulator Value (C5)
W	CfnPV	FFFDDD	0 ~ 255255	Counter Accumulator Value
W	N7	DDD	0 ~ 255	Integer data file (N7)
W	N10~15	DDD	0 ~ 255	Integer data file (N10~15)
W	F8	DDD	0 ~ 255	Floating point data file (F8)
W	Nfn	FFFDDD	0 ~ 255255	Integer data file (N7, 10~254)
W	Ffn	FFFDDD	0 ~ 255255	
W	Lfn	FFFDDD	0 ~ 255255	

Wiring Diagram:

9P D-Sub to 8P Mini-DIN: MicroLogix 1000, 1100, 1200, 1500

HMI COM1 RS232 9P D-Sub Male	HMI COM2 RS232 9P D-Sub Male	HMI COM3 RS232 9P D-Sub Female	MicroLogix RS232 8P Mini-DIN
2 RX	6 RX	8 RX	7 TXD
3 TX	4 TX	7 TX	4 RXD
5 GND	5 GND	5 GND	8 GND



9P D-Sub to 9P D-Sub: SLC5/03, 04, 05 CH0

HMI COM1 RS232 9P D-Sub Male	HMI COM2 RS232 9P D-Sub Male	HMI COM3 RS232 9P D-Sub Female	AB CPU CH0 RS232 9P D-Sub Male
2 RX	6 RX	8 RX	3 TD
3 TX	4 TX	7 TX	2 RD
5 GND	5 GND	5 GND	5 GND



Driver Version:

Version	Date	Description
V2.30	Apr/26/2010	

Allen-Bradley DH485

Supported series: Allen-Bradley MicroLogix 1000, 1100, 1200, 1500, SLC 5/03, 5/04, 5/05.

Website: <http://www.ab.com>

HMI Setting:

Parameters	Recommend	Option	Notes
PLC type	Allen-Bradley DH485		
PLC I/F	RS485 2W	RS232	
Baud rate	19200	9600, 19200	
Parity	Even		
Data bits	8		
Stop bits	1		
HMI st. no.	0	2	
PLC st. no.	1	1-31	

Online simulation	YES	
Extend address mode	NO	

PLC Setting:

Communication mode	DH485 protocol 19200 (default) Set the Max. Node Address as exactly how many PLCs you have.
--------------------	--

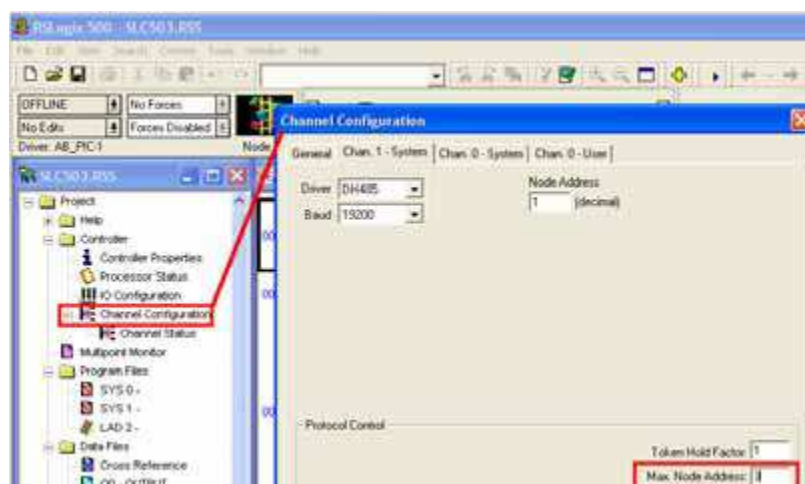

Device Address:

Bit/Word	Device type	Format	Range	Memo
B	I1	DDDdd	0 ~ 25515	Input (I)
B	O0	DDDdd	0 ~ 25515	Output (O)
B	B3	DDDdd	0 ~ 25515	Bit data file (B3)
B	B10~13	DDDdd	0 ~ 25515	Bit data file (B10~13)
B	Bfn	FFFDDDDdd	0 ~ 25525515	Bit data file (B3, 10~254)
B	NfnBit	FFFDDDDdd	0 ~ 25525515	Integer data file bit level (N7, 10~254)
B	S_Bit	DDDdd	0 ~ 25515	Status file
W	T4SV	DDD	0 ~ 255	Timer Preset Value (T4)
W	T4PV	DDD	0 ~ 255	Timer Accumulator Value (T4)
W	C5SV	DDD	0 ~ 255	Counter Preset Value (C5)
W	C5PV	DDD	0 ~ 255	Counter Accumulator Value (C5)
W	TfnSV	FFFDDD	0 ~ 255255	Timer Preset Value
W	TfnPV	FFFDDD	0 ~ 255255	Timer Accumulator Value
W	CfnSV	FFFDDD	0 ~ 255255	Counter Preset Value
W	CfnPV	FFFDDD	0 ~ 255255	Counter Accumulator Value
W	N7	DDD	0 ~ 255	Integer data file (N7)
W	N10~15	DDD	0 ~ 255	Integer data file (N10~15)
W	F8	DDD	0 ~ 255	Floating point data file (F8)
W	Nfn	FFFDDD	0 ~ 255255	Integer data file (N7, 10~254)
W	S	DDD	0 ~ 255	Status file

Wiring Diagram:

RS-485: SLC500 Fixed type, SLC5/01, 02, 03 CH1.

HMI can't connect to 1747-AIC peripheral port.

HMI COM1 RS485 2W 9P D-Sub Female	HMI COM3 RS485 2W 9P D-Sub Female		AB SLC500 DH485 RJ8 clip style port
1 RX-	6 Data-		2 SDB
2 RX+	9 Data+		1 SDA
5 GND	5 GND		7 GND



9P D-Sub to 8P Mini-DIN: MicroLogix 1000, 1100, 1200, and 1500 must set DH485 protocol.

HMI COM1 RS232 9P D-Sub Male	HMI COM2 RS232 9P D-Sub Male	HMI COM3 RS232 9P D-Sub Female	MicroLogix RS232 8P Mini-DIN
2 RX	6 RX	8 RX	7 TXD
3 TX	4 TX	7 TX	4 RXD
5 GND	5 GND	5 GND	8 GND



9P D-Sub to 9P D-Sub: SLC5/03, 04, 05 CH0 must set DH485 protocol.

HMI COM1 RS232 9P D-Sub Male	HMI COM2 RS232 9P D-Sub Male	HMI COM3 RS232 9P D-Sub Female	AB CPU CH0 RS232 9P D-Sub Male
2 RX	6 RX	8 RX	3 TD
3 TX	4 TX	7 TX	2 RD
5 GND	5 GND	5 GND	5 GND



Note: AB DH485 supports HMI X and iH series only.

Driver Version:

Version	Date	Description
V1.20	Apr/17/2009	

Allen-Bradley EtherNet/IP (CompactLogix)

Supported series: Allen-Bradley ControlLogix, CompactLogix, FlexLogix Ethernet.

Website: <http://www.ab.com>

HMI Setting:

Parameters	Recommend	Option	Notes
PLC type	Allen-Bradley EtherNet/IP (CompactLogix)		
PLC I/F	Ethernet		
Port no.	44818		
PLC st. no.	1		

PLC Setting:

RSLogix 5000 setting

Create the Tag:

The name format must use 4 chars like B003, T004, C005, N007, and F008.

Two or three chars are not available. For example: B03 or B3.



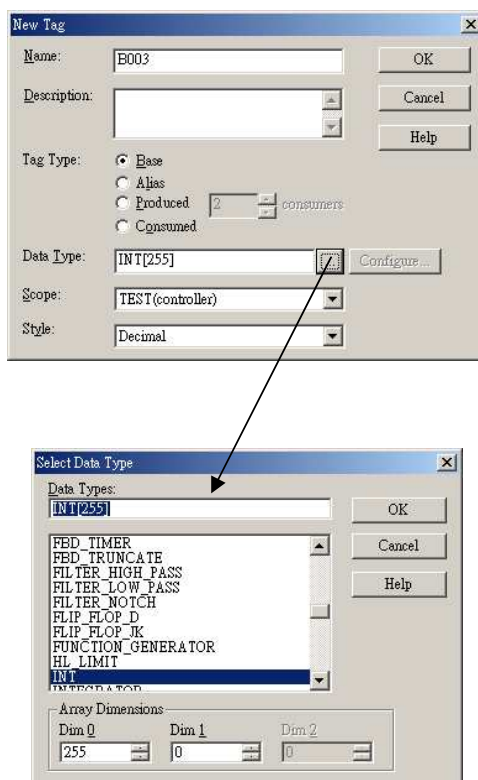

Device Address:

Bit/Word	Device type	Format	Range	Memo
B	Bx_BOOL	FFFDDDDd	0 ~ 25525515	Bit data file
B	Nx_BOOL	FFFDDDDd	0 ~ 25525515	Integer data file bit level (N7, 10~99)
W	Bx_INT	FFFDDD	0 ~ 255255	Bit data file word level
W	Nx_INT	FFFDDD	0 ~ 255255	Integer data file (N7, 10~99)
F	F8_REAL	DDD	0~ 255	Floating point data file (F8)
F	Fx_REAL	FFFDDD	0 ~ 255255	Floating point data file (F8)
DW	Tx.PRE	FFFDDD	0 ~ 255255	Timer Preset Value (T4, T10~255)
DW	Tx.ACC	FFFDDD	0 ~ 255255	Timer Accumulator Value (T4, T10~255)
DW	Cx.PRE	FFFDDD	0 ~ 255255	Counter Preset Value (C5, C10~255)
DW	Cx.ACC	FFFDDD	0 ~ 255255	Counter Accumulator Value (C5, C10~255)

Wiring Diagram:

Direct connect (crossover cable):

HMI RJ45 Female	Wire Color	PLC RJ45 Female
1 TX+	White/Orange	3 RX+
2 TX-	Orange	6 RX-
3 RX+	White/Green	1 TX+
4 BD4+	Blue	4 BD4+
5 BD4-	White/Blue	5 BD4-
6 RX-	Green	2 TX-
7 BD3+	White/Brown	7 BD3+
8 BD3-	Brown	8 BD3-



Through a hub:

HMI RJ45 Female	Wire Color	PLC RJ45 Female
1 TX+	White/Orange	1 TX+
2 TX-	Orange	2 TX-
3 RX+	White/Green	3 RX+
4 BD4+	Blue	4 BD4+
5 BD4-	White/Blue	5 BD4-
6 RX-	Green	6 RX-
7 BD3+	White/Brown	7 BD3+
8 BD3-	Brown	8 BD3-



Driver Version:

Version	Date	Description
V1.10	Dec/30/2008	

Allen-Bradley EtherNet/IP (CompactLogix) – Free Tag Names

Supported series: Allen-Bradley CompactLogix, FlexLogix Ethernet

Website: <http://www.ab.com>

HMI Setting:

Parameters	Recommend	Option	Notes
PLC type	Allen-Bradley EtherNet/IP (CompactLogix) – Free Tag Names		
PLC I/F	Ethernet		
Port no.	44818		
PLC st no.	1		

PLC Setting:

1. Set PLC IP address.

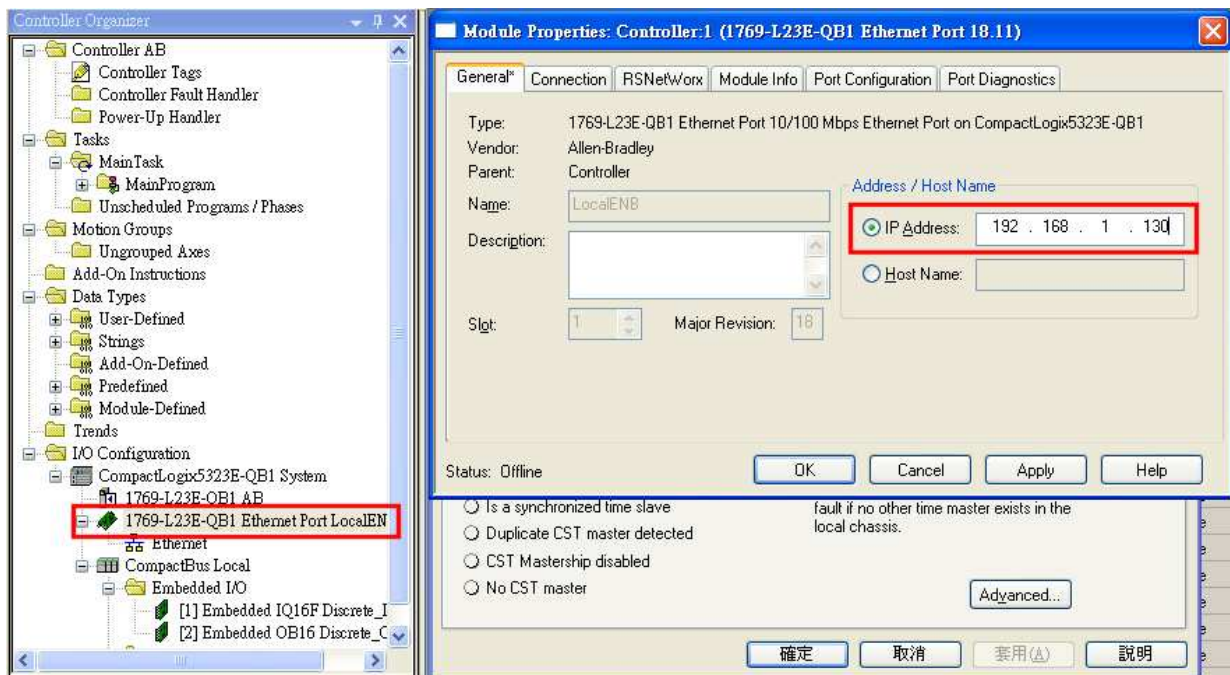

2. Create Tags.

Name	Value	Force Mask	Style	Data Type
+ ABC	56		Decimal	DINT
+ Array2D	{...}	{...}	Decimal	DINT[25,5]
+ ArrayBool	{...}	{...}	Decimal	BOOL[256]
+ ArrayDINT	{...}	{...}	Decimal	DINT[130]
+ ArrayReal	{...}	{...}	Float	REAL[125]
b1	0		Decimal	BOOL
+ INT	{...}	{...}	Decimal	INT[360]
+ Local1:C	{...}	{...}		AB:Embedded_IQ...
+ Local1:I	{...}	{...}		AB:Embedded_IQ...
+ Local2:C	{...}	{...}		AB:Embedded_O...
+ Local2:I	{...}	{...}		AB:Embedded_O...
+ Local2:O	{...}	{...}		AB:Embedded_O...
VarBool	0		Decimal	BOOL
+ VarDint	21862		Decimal	DINT
+ VarInt	0		Decimal	INT
VarReal	0.0		Float	REAL
+ VarSint	-128		Decimal	SINT

3. Export Tags data to CSV file.

4. In EB8000, create Allen-Bradley EtherNet/IP-Tag (CompactLogix) driver.

Input PLC IP address. In System Parameter Settings dialog click [Import Tag...] button.

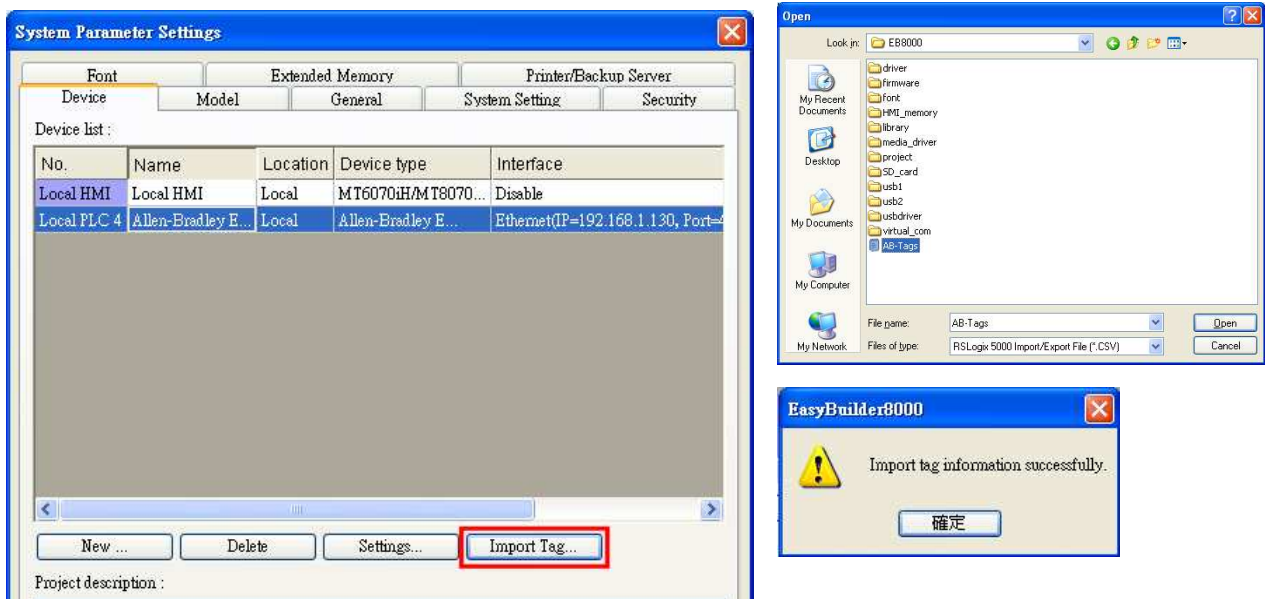

5. In object dialog, select PLC, click Tag and select a controller tag.

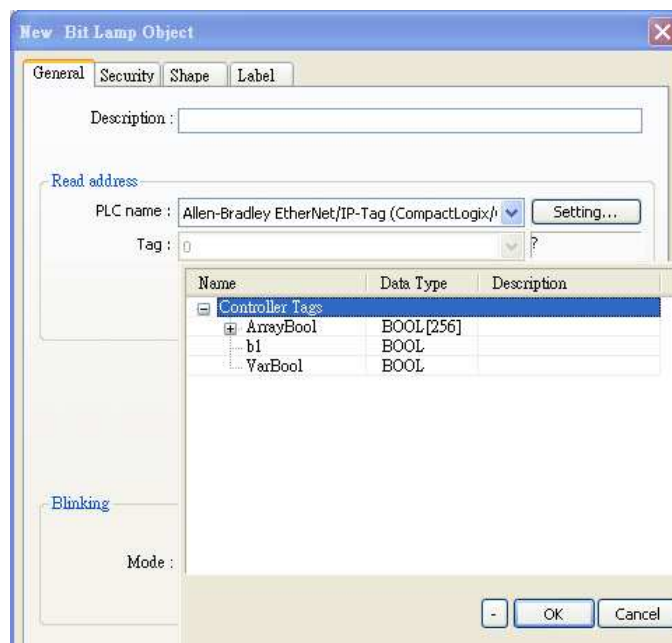

Device Address:

PLC data type name	Bit/Word	EB8000 data format	Memo
BOOL	Boolean	Bit object	
BitArray			
DINT	Double Integer	32-bit signed	$-2^{31} \sim (2^{31}-1)$
REAL	Single Precision Float	32-bit Float	IEEE 754
INT	Integer	16-bit signed, ASCII	-32768~32767
SINT			

Wiring Diagram:

Direct connect (crossover cable):

HMI RJ45 Female	Wire Color	PLC RJ45 Female
1 TX+	White/Orange	3 RX+
2 TX-	Orange	6 RX-
3 RX+	White/Green	1 TX+
4 BD4+	Blue	4 BD4+
5 BD4-	White/Blue	5 BD4-
6 RX-	Green	2 TX-
7 BD3+	White/Brown	7 BD3+
8 BD3-	Brown	8 BD3-



Through a hub:

HMI RJ45 Female	Wire Color	PLC RJ45 Female
1 TX+	White/Orange	1 TX+
2 TX-	Orange	2 TX-
3 RX+	White/Green	3 RX+
4 BD4+	Blue	4 BD4+
5 BD4-	White/Blue	5 BD4-
6 RX-	Green	6 RX-
7 BD3+	White/Brown	7 BD3+
8 BD3-	Brown	8 BD3-



Driver Version:

Version	Date	Description
V1.10	Aug/25/2010	

Allen-Bradley EtherNet/IP (ControlLogix) – Free Tag Names

Supported series: Allen-Bradley ControlLogix, CompactLogix, FlexLogix Ethernet.

Website: <http://www.ab.com>

HMI Setting:

Parameters	Recommend	Option	Notes
PLC type	Allen-Bradley EtherNet/IP (ControlLogix) – Free Tag Names		
PLC I/F	Ethernet		
Port no.	44818		
PLC st. no.	The same as CPU Slot No.		

PLC Setting:

1. Set PLC IP address.

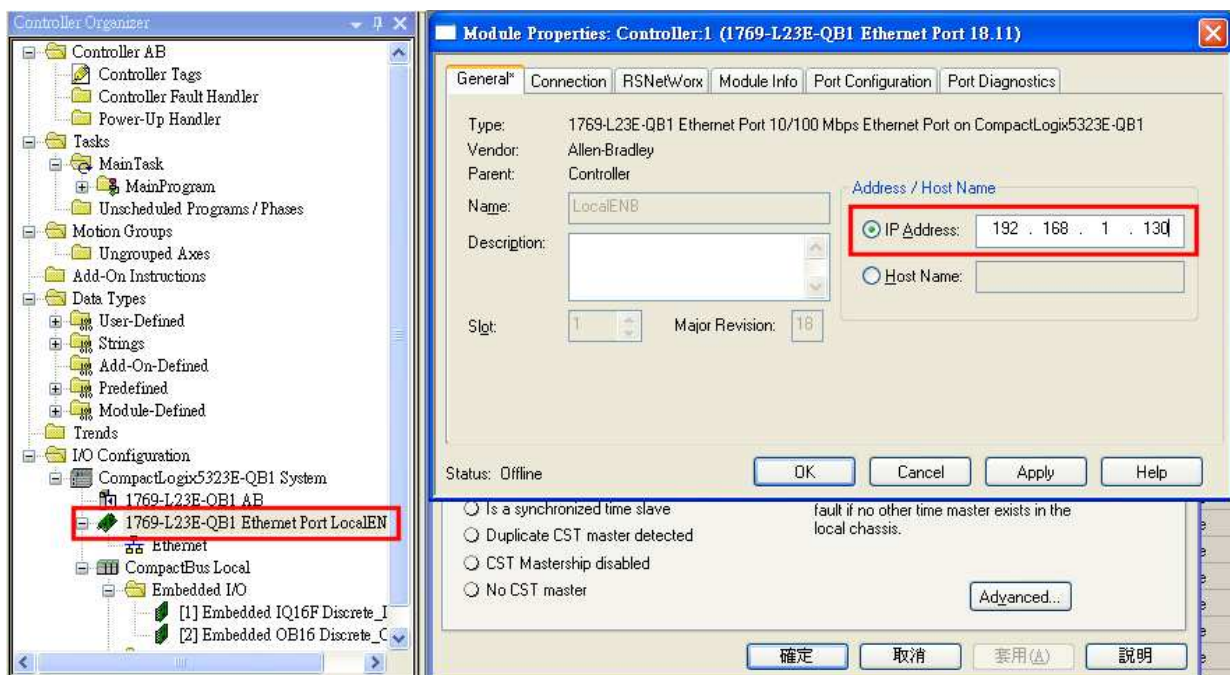

2. Create Tags.

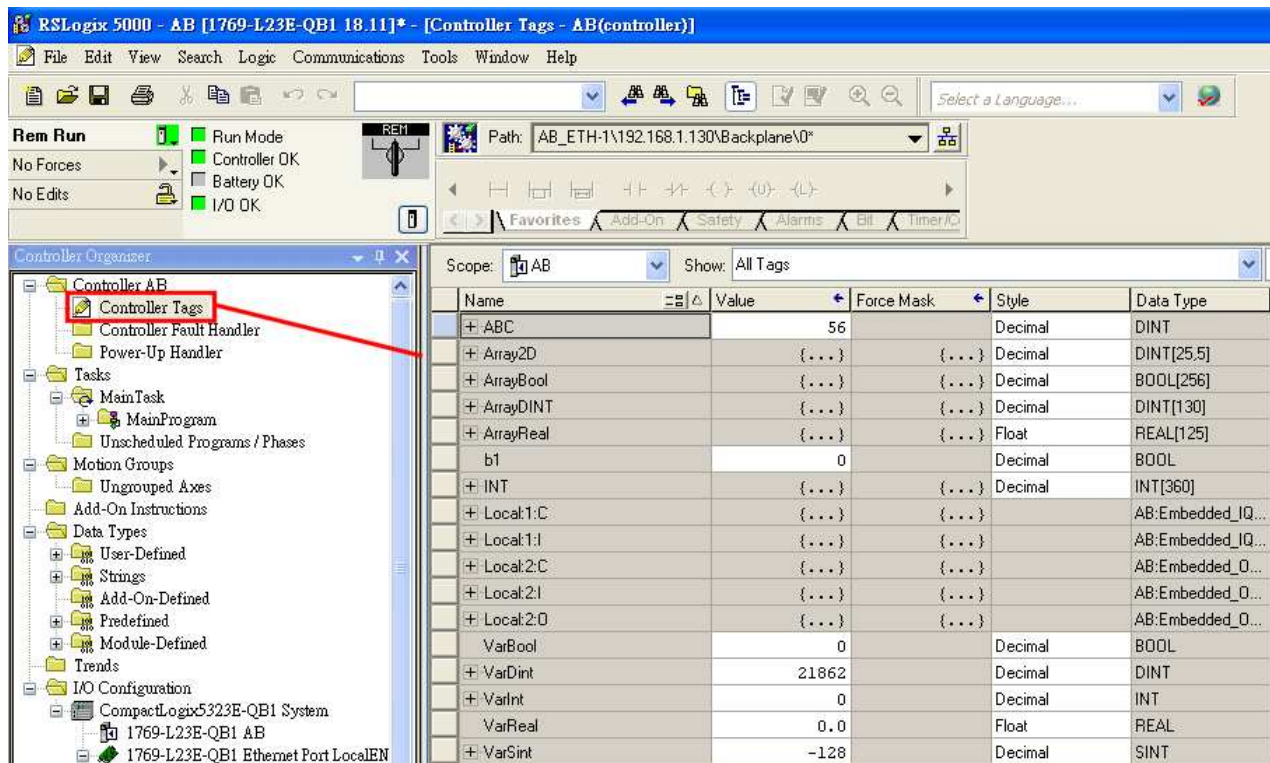

3. Export Tags data to CSV file.

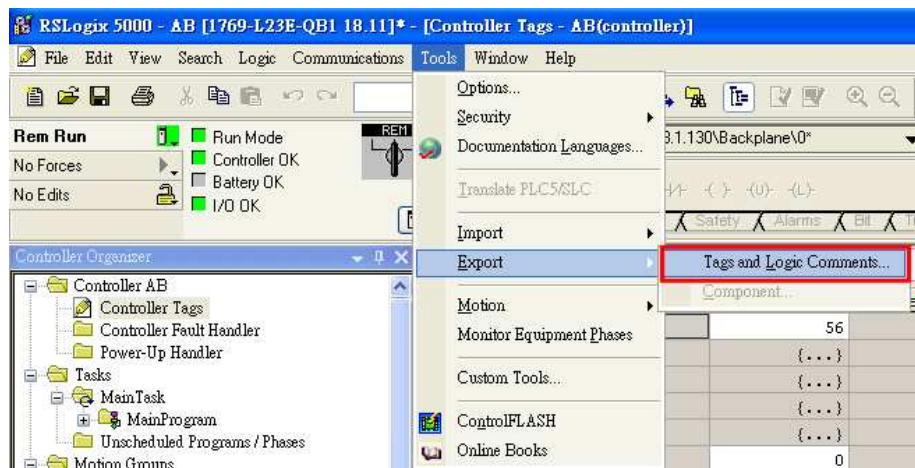

4. In EB8000, create Allen-Bradley EtherNet/IP-Tag (ControlLogix) driver. Input PLC IP address. In System Parameter Settings dialog click [Import Tag...] button.

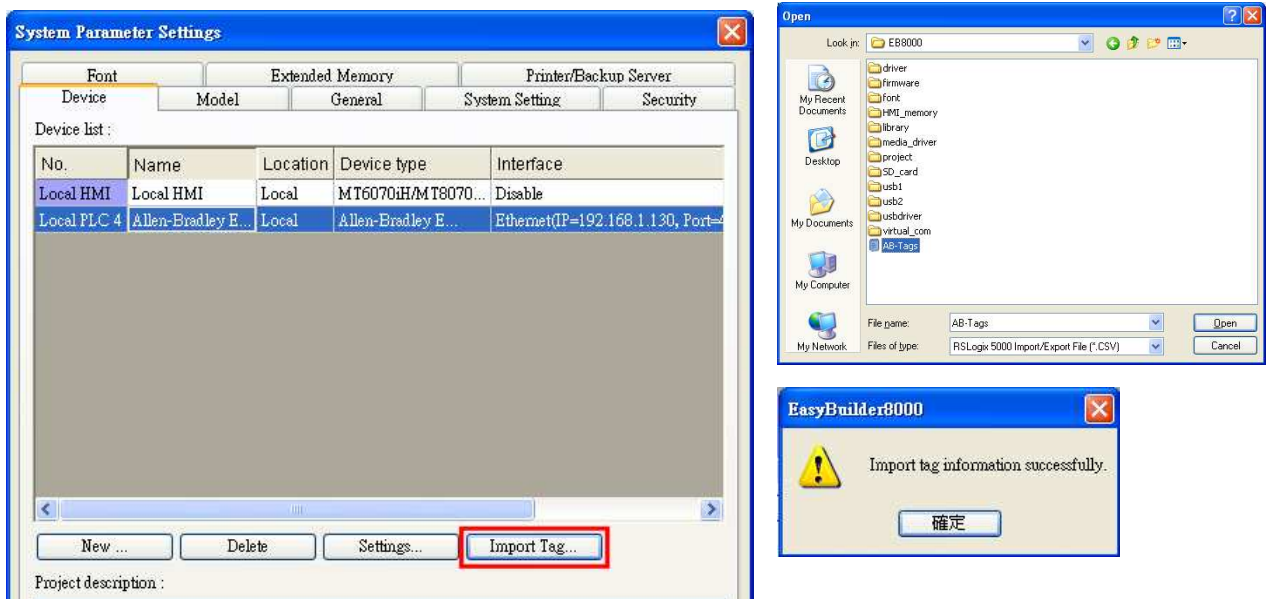

5. In object dialog, select PLC, click Tag and select a controller tag.

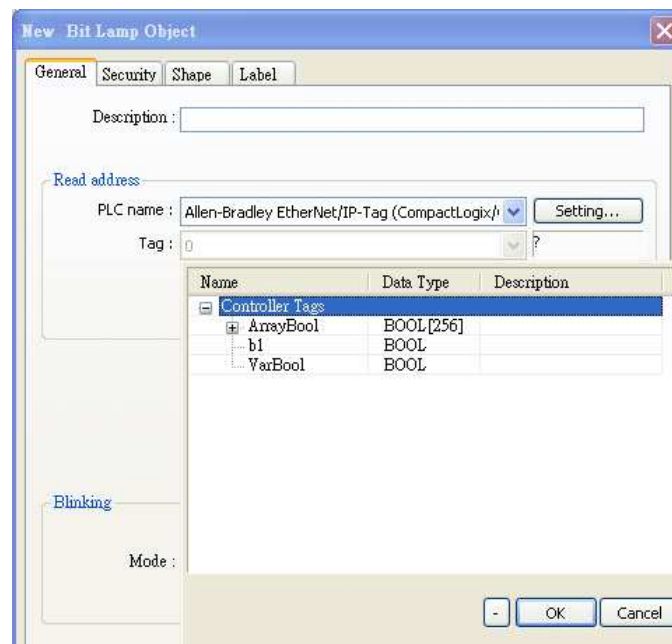

Device Address:

PLC data type name	Bit/Word	EB8000 data format	Memo
BOOL	Boolean	Bit object	
BitArray			
DINT	Double Integer	32-bit signed	$-2^{31} \sim (2^{31}-1)$
REAL	Single Precision Float	32-bit Float	IEEE 754
INT	Integer	16-bit signed, ASCII	$-32768 \sim 32767$
SINT			

Wiring Diagram:

Direct connect (crossover cable):

HMI RJ45 Female	Wire Color	PLC RJ45 Female
1 TX+	White/Orange	3 RX+
2 TX-	Orange	6 RX-
3 RX+	White/Green	1 TX+
4 BD4+	Blue	4 BD4+
5 BD4-	White/Blue	5 BD4-
6 RX-	Green	2 TX-
7 BD3+	White/Brown	7 BD3+
8 BD3-	Brown	8 BD3-



Through a hub:

HMI RJ45 Female	Wire Color	PLC RJ45 Female
1 TX+	White/Orange	1 TX+
2 TX-	Orange	2 TX-
3 RX+	White/Green	3 RX+
4 BD4+	Blue	4 BD4+
5 BD4-	White/Blue	5 BD4-
6 RX-	Green	6 RX-
7 BD3+	White/Brown	7 BD3+
8 BD3-	Brown	8 BD3-



Driver Version:

Version	Date	Description
V1.10	Oct/05/2010	

Allen-Bradley EtherNet/IP (DF1)

Supported series: Allen-Bradley MicroLogix 1100, 1400, SLC5/05 Ethernet port.
MicroLogix1000, 1200, 1500, SLC 5/03, 5/04 with 1761-NET-ENI

Website: <http://www.ab.com>

HMI Setting:

Parameters	Recommend	Option	Notes
PLC type	Allen-Bradley EtherNet/IP (DF1)		
PLC I/F	Ethernet		
Port no.	44818		
HMI st no.	0		
PLC st. no.	1		

PLC Setting:

Communication mode	Port Setting: 10/100 Mbps Full Duplex/Half Duplex
--------------------	---

Device Address:

Bit/Word	Device type	Format	Range	Memo
B	I1	DDDdd	0 ~ 25515	Input (I)
B	O0	DDDdd	0 ~ 25515	Output (O)
B	B3	DDDdd	0 ~ 25515	Bit data file (B3)
B	Bfn	FFFDDDdd	0 ~ 25525515	Bit data file (B3, 10~254)
B	NfnBit	FFFDDDdd	0 ~ 25525515	Integer data file bit level (N7, 10~254)
B	S_Bit	DDDDDDdd	0 ~ 25525515	Status file
W	T4SV	DDD	0 ~ 255	Timer Preset Value (T4)
W	T4PV	DDD	0 ~ 255	Timer Accumulator Value (T4)
W	C5SV	DDD	0 ~ 255	Counter Preset Value (C5)
W	C5PV	DDD	0 ~ 255	Counter Accumulator Value (C5)
W	N7	DDD	0 ~ 255	Integer data file (N7)

W	Nfn	FFFDDD	0 ~ 255255	Integer data file (N7, 10~254)
32bit Float	F8	DDD	0 ~ 255	Floating point data file (F8)
32bit Float	Ffn	FFFDDD	0 ~ 255255	Floating point data file (F8, 10~254)
DW	Lfn	FFFDDD	0 ~ 255255	Driver version 2.00 or above support
W	TfnSV	FFFDDD	0 ~ 255255	
W	TfnPV	FFFDDD	0 ~ 255255	
W	CfnSV	FFFDDD	0 ~ 255255	
W	CfnPV	FFFDDD	0 ~ 255255	
W	S	DDD	0 ~ 255	

Wiring Diagram:

Direct connect (crossover cable):

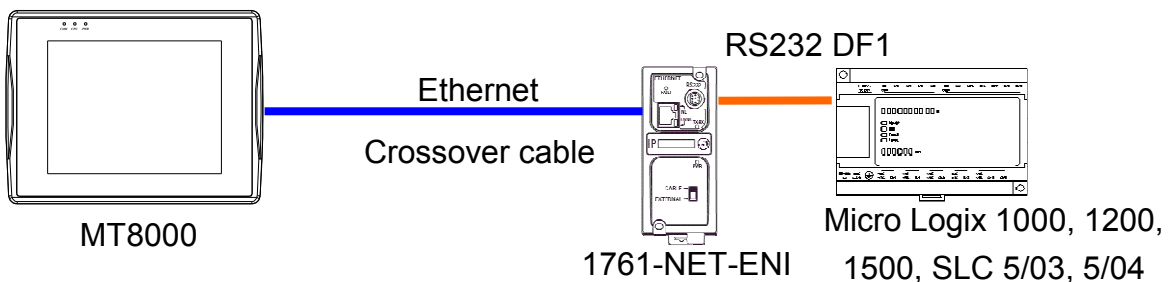

HMI RJ45 Female	Wire Color	PLC RJ45 Female
1 TX+	White/Orange	3 RX+
2 TX-	Orange	6 RX-
3 RX+	White/Green	1 TX+
4 BD4+	Blue	4 BD4+
5 BD4-	White/Blue	5 BD4-
6 RX-	Green	2 TX-
7 BD3+	White/Brown	7 BD3+
8 BD3-	Brown	8 BD3-

Through a hub:

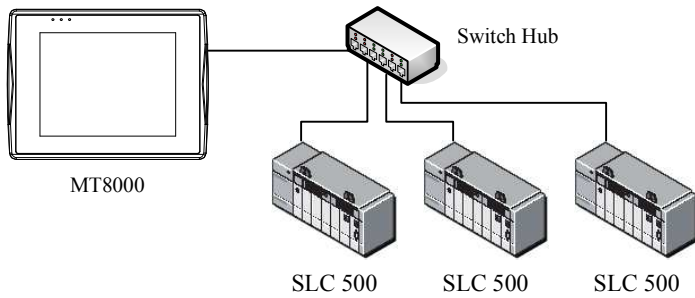

HMI RJ45 Female	Wire Color	PLC RJ45 Female
1 TX+	White/Orange	1 TX+
2 TX-	Orange	2 TX-
3 RX+	White/Green	3 RX+
4 BD4+	Blue	4 BD4+
5 BD4-	White/Blue	5 BD4-
6 RX-	Green	6 RX-
7 BD3+	White/Brown	7 BD3+
8 BD3-	Brown	8 BD3-



Driver Version:

Version	Date	Description
V2.00	Dec/21/2009	Add Lfn register.

Allen-Bradley PLC5

Website: <http://www.ab.com>

HMI Setting:

Parameters	Recommend	Option	Notes
PLC type	Allen-Bradley PLC5		
PLC I/F	RS232		
Baud rate	19200	9600, 19200	
Parity	Even	Even, Odd, None	
Data bits	8	8	
Stop bits	1	1	
HMI st. no.	0		
PLC st. no.	1	1-31	

PLC Setting:

Communication mode	DF1 Full Duplex protocol 19200, None, 8, 1 (default)
--------------------	--

Allen-Bradley PLC-5 Family PLCs using the DF1 Full Duplex protocol.

For the PLC-5/10, PLC-5/15 and PLC-5/25 the MT8000 should be connected to the DF1 port on the 1785-KE module; for the PLC-5/11, PLC-5/20, PLC-5/30 and PLC-5/40 the MT8000 should be connected to the Channel 0 Port on the PLC.

Device Address:

Bit/Word	Device type	Format	Range	Memo
B	I1	DDDdd	0 ~ 25515	Input (I)
B	O0	DDDdd	0 ~ 25515	Output (O)
B	B3	DDDdd	0 ~ 25515	Bit data file (B3)
B	B10~13	DDDdd	0 ~ 25515	Bit data file (B10~13)
B	S_Bit	DDDDDDdd	0 ~ 25599915	
B	Bfn	FFFDDDDdd	0 ~ 25599915	
B	NfnBit	FFFDDDDdd	0 ~ 25599915	
W	T4SV	DDD	0 ~ 999	Timer Preset Value (T4)
W	T4PV	DDD	0 ~ 999	Timer Accumulator Value (T4)

Bit/Word	Device type	Format	Range	Memo
W	C5SV	DDD	0 ~ 999	Counter Preset Value (C5)
W	C5PV	DDD	0 ~ 999	Counter Accumulator Value (C5)
W	N7	DDD	0 ~ 999	Integer data file (N7)
W	N10~15	DDD	0 ~ 999	Integer data file (N10~15)
W	F8	DDD	0 ~ 999	Floating point data file (F8)
W	Nfn	FFFDDD	0 ~ 255999	Integer data file (V2.5.0 or newer)
W	Ffn	FFFDDD	0 ~ 255999	Floating point data file (V2.5.0 or newer)
W	TfnSV	FFFDDD	0 ~ 255999	
W	TfnPV	FFFDDD	0 ~ 255999	
W	CfnSV	FFFDDD	0 ~ 255999	
W	CfnPV	FFFDDD	0 ~ 255999	
W	S	DDD	0 ~ 255	

Wiring Diagram:

9P D-Sub to 25P D-Sub: PLC5 CPU CH0

HMI COM1 RS232 9P D-Sub Male	HMI COM2 RS232 9P D-Sub Male	HMI COM3 RS232 9P D-Sub Female	AB CPU CH0 RS232 25P D-Sub Male
2 RX	6 RX	8 RX	3 TD
3 TX	4 TX	7 TX	2 RD
5 GND	5 GND	5 GND	5 GND



Note:

The default error check of AB PLC5 is BCC, whereas our driver is CRC.

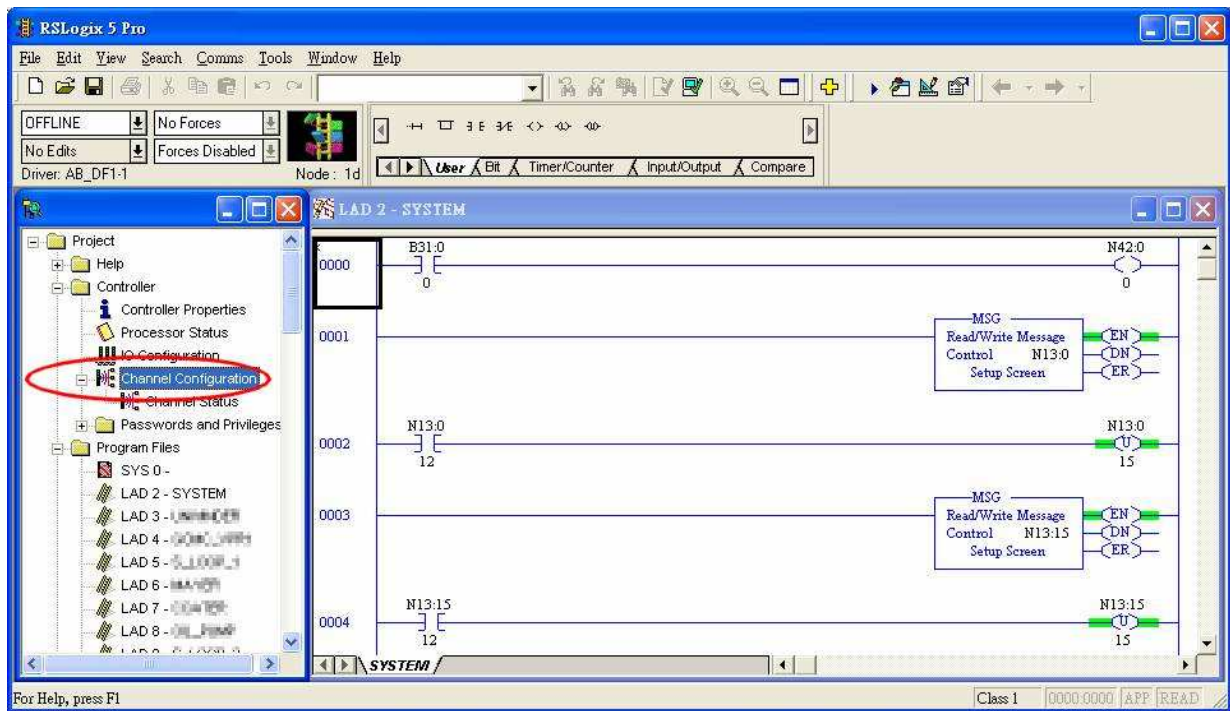

Access “Channel Configuration” from RSLogix5, under Channel 0 tab, please select CRC for Error Detect.

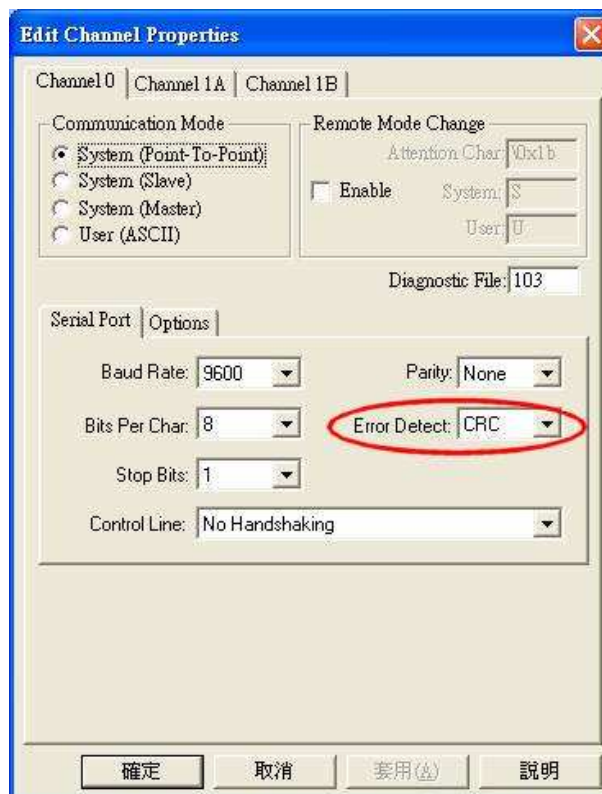

Driver Version:

Version	Date	Description
V1.20	Apr/17/2009	

Altus ALNET-I

Supported series: Altus SeriesMode PO3042, PO3142, PO3242, PO3342, PL103 ,PL104, PL105, QK800, QK801, QK2000.

HMI Setting:

Parameters	Recommend	Option	Notes
PLC type	altus ALNET-I		
PLC I/F	RS232		
Baud rate	9600		
Parity	Even		
Data bits	8		
Stop bits	1		
PLC st. no.	0		

Device Address:

Bit/Word	Device Type	Format	Range	Device Range
B	M_Bit	DDDDh	0 ~ 1023f	Memories
B	A	DDDh	0 ~ 511f	Auxiliary Relays
B	E	DDDh	0 ~ 511f	Input Relays
B	D_Bit	DDDDdd	0 ~ 102331	Decimals
B	F_Bit	DDDDdd	0 ~ 102331	Reals
B	I_Bit	DDDDdd	0 ~ 102331	Integers
B	S	DDDh	0 ~ 511f	Output Relays
W	M	DDDD	0 ~ 4096	Memories
DW	D	DDDD	0 ~ 4096	Decimals
DW	F	DDDD	0 ~ 1023	Reals
DW	I	DDDD	0 ~ 1023	Integers
W	TM	HHHH	0 ~ ffff*	Memory Tables
DW	TD	HHHH	0 ~ ffff*	Decimal Tables
DW	TF	HHHH	0 ~ ffff*	Real Tables
DW	TI	HHHH	0 ~ ffff*	Integer Tables

Note: TM, TD, TF and TI in PLC software's format are TXA[B], M, D, F, I types are X.

B address range is 0 ~ FF, and A address range is 0 ~ FF; the device type is AABB, the range is depend on the PLC settings.

For example Model PO3242 “A” range is ”0” and “B” range is 0 ~ 7.

Wiring Diagram:

9P D-Sub to 8P RJ45: PLC PO3042, PO3142, PO3242, PO3342

HMI COM1 RS232 9P D-Sub Male	HMI COM2 RS232 9P D-Sub Male	HMI COM3 RS232 9P D-Sub Female	PLC RS232 8P RJ45
2 RX	6 RX	8 RX	2 TX
3 TX	4 TX	7 TX	3 RX
5 GND	5 GND	5 GND	5 GND



9P D-Sub to 9P D-Sub: PLC PL103, PL104, PL105

HMI COM1 RS232 9P D-Sub Male	HMI COM2 RS232 9P D-Sub Male	HMI COM3 RS232 9P D-Sub Female	PLC RS232 9P D-Sub
2 RX	6 RX	8 RX	7 TX
3 TX	4 TX	7 TX	1 RX
5 GND	5 GND	5 GND	5 GND



9P D-Sub to 9P D-Sub: PLC QK800, QK801, QK2000.

HMI COM1 RS232 9P D-Sub Male	HMI COM2 RS232 9P D-Sub Male	HMI COM3 RS232 9P D-Sub Female	PLC RS232 9P D-Sub
2 RX	6 RX	8 RX	2 TX
3 TX	4 TX	7 TX	3 RX
5 GND	5 GND	5 GND	7 GND

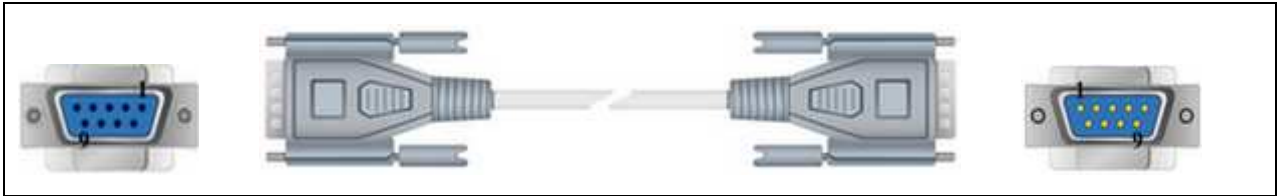

Driver Version:

Version	Date	Description
V1.10	Jul/24/2009	

Baumuller

Website: <http://www.baumuller.com/>

HMI Setting:

Parameters	Recommend	Option	Notes
PLC type	Baumuller		
PLC I/F	RS485 4W		
Baud rate	19200	9600, 19200	
Parity	Even	Even, Odd, None	
Data bits	8	7 or 8	
Stop bits	1	1 or 2	
HMI st. no.	0		
PLC st. no.	0	Defaults	

PLC Setting:

Communication mode	RK 512 Protocol, 19200, 8, 1, Even
--------------------	------------------------------------

Device Address:

Bit/Word	Device type	Format	Range	Memo
B	DB0_bit ~ DB29_bit	DDDh	0 ~ 255f	
W	DB0 ~ DB29	DDD	0 ~ 255	

Wiring Diagram:

9P D-Sub to 9P D-Sub:

HMI COM1 RS485 4W 9P D-Sub Female			Baumuller servo RS422 9P D-Sub Female
1 RX-			1 TXD-
2 RX+			9 TXD+
3 TX-			5 RXD-
4 TX+			6 RXD+
5 GND			8 GND



Driver Version:

Version	Date	Description
V1.10	Apr/17/2009	

Change

Supported series: Compressor controller

HMI Setting:

Parameters	Recommend	Option	Notes
PLC type	Change		
PLC I/F	RS485 2W		
Baud rate	9600		
Parity	None		
Data bits	8		
Stop bits	1		
PLC st. no.	1	1~6	

Device Address:

Bit/Word	Device type	Format	Range	Memo
B	CTL	DDD	0 ~ 5, 128, 150	Write only
DW	SET	DDD	1 ~ 57, 128	
DW	STATUS	DD	1 ~ 20	Read only

Wiring Diagram:

9P D-Sub to 9P D-Sub:

HMI COM1 RS485 2W 9P D-Sub Female	HMI COM3 RS485 2W 9P D-Sub Female		Change RS485 2W
1 RX-	6 Data-		15 D-
2 RX+	9 Data+		16 D+
5 GND	5 GND		



Driver Version:

Version	Date	Description
V1.00	Jan/07/2011	Driver released

Cimon CM1-CP4A/ECO1A

Supported series: Cimon CM1 series, CP4A module

Website: <http://www.kdtsys.com>

HMI Setting:

Parameters	Recommend	Option	Notes
PLC type	Cimon CM1-CP4A/ECO1A		
PLC I/F	RS232		
Baud rate	38400		
Data bits	8		
Parity	None		
Stop bits	1		
PLC st. no.	1		

Device Address:

Bit/Word	Device type	Format	Range	Memo
B	X	DDh	0 ~ 23f	0-1F read only
B	Y	DDh	0 ~ 23f	
B	M	DDDh	0 ~ 511f	
B	K	DDDh	0 ~ 127f	
B	T	DDDh	0 ~ 102f	
B	C	DDDh	0 ~ 102f	
B	L	DDDh	0 ~ 127f	
B	F	DDDh	0 ~ 127f	Read only
W	D	DDDD	0 ~ 4999	
W	S	DD	0 ~ 99	Max. range: 99
W	TS	DDDD	0 ~ 1023	
W	TC	DDDD	0 ~ 1023	
W	CC	DDDD	0 ~ 1023	
W	CS	DDDD	0 ~ 1023	

Wiring Diagram:

9P D-Sub to 6P RJ11:

HMI COM1 RS232 9P D-Sub Male	HMI COM2 RS232 9P D-Sub Male	HMI COM3 RS232 9P D-Sub Female	CM1-CP4A RS232 6P RJ11 Female
2 RX	6 RX	8 RX	2 TXD
3 TX	4 TX	7 TX	3 RXD
5 GND	5 GND	5 GND	5 GND



Driver Version:

Version	Date	Description
V1.20	Nov/30/2009	

Cimon CM1-SC02A

Supported series: Cimon CM series, SC02A module

Website: <http://www.kdtsys.com>

HMI Setting:

Parameters	Recommend	Option	Notes
PLC type	Cimon CM1-SC02A		
Com port	RS232		
Baud rate	38400		
Data bits	8		
Parity	None		
Stop bits	1		
PLC st. no.	1		

Device Address:

Bit/Word	Device type	Format	Range	Memo
B	X	DDh	0 ~ 23f	0-1F read only
B	Y	DDh	0 ~ 23f	0-F read only
B	M	DDDh	0 ~ 511f	
B	K	DDDh	0 ~ 127f	
B	T	DDDh	0 ~ 102f	
B	C	DDDh	0 ~ 102f	
B	L	DDDh	0 ~ 127f	
B	F	DDDh	0 ~ 127f	Read only
W	D	DDDD	0 ~ 4999	
W	S	DD	0 ~ 99	Max. range: 99
W	TS	DDDD	0 ~ 1023	
W	TC	DDDD	0 ~ 1023	
W	CC	DDDD	0 ~ 1023	
W	CS	DDDD	0 ~ 1023	

Wiring Diagram:

9P D-Sub to 9P D-Sub:

HMI COM1 RS232 9P D-Sub Male	HMI COM2 RS232 9P D-Sub Male	HMI COM3 RS232 9P D-Sub Female	CM1-SC02A RS232 9P D-Sub Male
2 RX	6 RX	8 RX	3 TD
3 TX	4 TX	7 TX	2 RD
5 GND	5 GND	5 GND	5 GND



Driver Version:

Version	Date	Description
V1.20	Nov/30/2009	

Copley Controls

Supported series: Digital Servo Driver & Controllers, Xenus, Xenus Micro, Accelnet, Accelnet Micro, Stepnet series.

Website: <http://www.copleycontrols.com/motion/>

HMI Setting:

Parameters	Recommend	Option	Notes
PLC type	Copley Controls		
PLC I/F	RS232		
Baud rate	9600	9600~115200	
Parity	None	Even, Odd, None	
Data bits	8	8	
Stop bits	1	1	
HMI st. no.	0		
PLC st. no.	0	0-127	

Device Address:

Bit/Word	Device type	Format	Range	Memo
W	Flash INT 16	HHH	0 ~ 999	For Register is INT16 or U16
W	RAM INT 16	HHH	0 ~ 999	For Register is INT16 or U16
W	Flash INT 32	HHH	0 ~ 999	For Register is INT32 or U32
W	RAM INT 32	HHH	0 ~ 999	For Register is INT32 or U32
W	Register	DDDD	0 ~ 2457	
W	T_command	H	0	
W	Reset	H	0	

Wiring Diagram:

9P D-Sub to 6P RJ11: Xenus, Xenus Micro, Accelnet

HMI COM1 RS232 9P D-Sub Male	HMI COM2 RS232 9P D-Sub Male	HMI COM3 RS232 9P D-Sub Female	Xenus Micro Panel RS232 6P RJ11 Female
2 RX	6 RX	8 RX	5 TXD
3 TX	4 TX	7 TX	2 RXD
5 GND	5 GND	5 GND	3, 4 GND

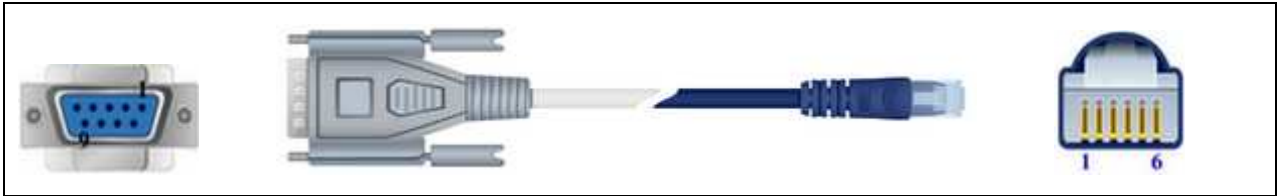

9P D-Sub to 6P RJ11: Stepnet

HMI COM1 RS232 9P D-Sub Male	HMI COM2 RS232 9P D-Sub Male	HMI COM3 RS232 9P D-Sub Female	Stepnet RS232 6P RJ11 Female
2 RX	6 RX	8 RX	5 TXD
3 TX	4 TX	7 TX	2 RXD
5 GND	5 GND	5 GND	3, 4 GND

Accelnet Micro:

HMI COM1 RS232 9P D-Sub Male	HMI COM2 RS232 9P D-Sub Male	HMI COM3 RS232 9P D-Sub Female	Accelnet Micro Panel RS232 J5 Cable Connector
2 RX	6 RX	8 RX	29 TXD
3 TX	4 TX	7 TX	14 RXD
5 GND	5 GND	5 GND	15 GND

Driver Version:

Version	Date	Description
V1.20	Dec/30/2008	

CROUZET M3 (FBD)

HMI Setting:

Parameters	Recommend	Option	Notes
PLC type	CROUZET M3 (FBD)		
PLC I/F	RS232		
Baud rate	115200		
Data bits	7		
Parity	Even		
Stop bits	1		
PLC st. no.	1		

Device Address:

Bit/Word	Device type	Format	Range	Memo
B	SLI_Bit	DDh	1(0) ~ 24(f)	Serial link input
B	SLO_Bit	DDh	25(0) ~ 48(f)	Serial link output (read only)
W	IA	DD	1 ~ 99	Analogy input (default: 1 ~ 4)
W	SL_IN	DD	1 ~ 24	Serial link input
W	SL_OUT	DD	25 ~ 48	Serial link output (read only)

Wiring Diagram:

9P D-Sub to 9P D-Sub:

HMI COM1 RS232 9P D-Sub Male			CROUZET M3 RS232 9P D-Sub Female (Extension Cable)
2 RX			2 TD
3 TX			3 RD
5 GND			5 GND
7 RTS			4 DTR





(3m serial link cable)
 Note: Please use 3m serial link cable (Accessories from Millenium 3) and extension cable (as above) to communicate with HMI series.

MT6050/8050i
 RS232
 9P D-SUB Male
 COM1

CROUZET CD12
 RS-232
 9P D-SUB Female
 (Extension cable)

6	TX	3	RD
9	RX	2	TD
5	GND	5	GND
4	TX+	4	DTR

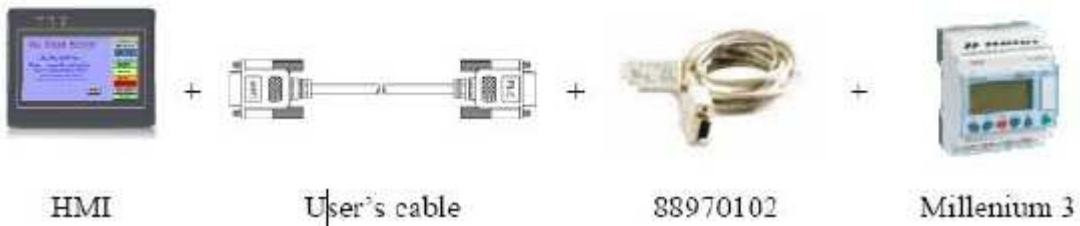

Driver Version:

Version	Date	Description
V1.10	Oct/26/2010	

CROUZET M3 (LAD)

HMI Setting:

Parameters	Recommend	Option	Notes
PLC type	CROUZET M3 (LAD)		
PLC I/F	RS232		
Baud rate	115200		
Data bits	7		
Parity	Even		
Stop bits	1		
PLC st. no.	1		

Device Address:

Bit/Word	Device type	Format	Range	Memo
B	I	DD	1 ~ 99	Input (default: 1 ~ 4)
B	O	DD	1 ~ 99	Output (default: 1 ~ 4)
B	M	DD	1 ~ 28	Relay
B	SLI_Bit	DDh	1(0) ~ 24(f)	Serial link input
B	SLO_Bit	DDh	25(0) ~ 48(f)	Serial link output (read only)
W	IA	DD	1 ~ 99	Analogy input (default: 1 ~ 4)
W	T	DD	1 ~ 12	Timer
W	C	DD	1 ~ 16	Counter
W	SL_IN	DD	1 ~ 24	Serial link input
W	SL_OUT	DD	25 ~ 48	Serial link output (read only)

Wiring Diagram:

9P D-Sub to 9P D-Sub:

HMI COM1 RS232 9P D-Sub Male			CROUZET M3 RS232 9P D-Sub Female (Extension Cable)
2 RX			2 TD
3 TX			3 RD
5 GND			5 GND
7 RTS			4 DTR



(3m serial link cable)

Note: Please use 3m serial link cable (Accessories from Millenium 3) and extension cable (as above) to communicate with HMI series.

MT6050/8050i
RS232
9P D-SUB Male
COM1

CROUZET CD12
RS-232
9P D-SUB Female
(Extension cable)

6 TX		3	RD
9 RX		2	TD
5 GND		5	GND
4 TX+		4	DTR

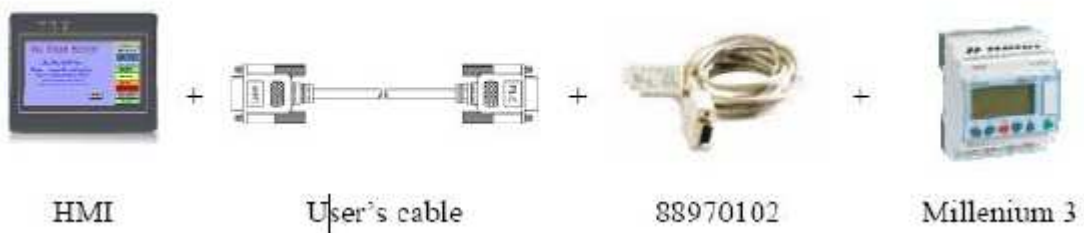

Driver Version:

Version	Date	Description
V1.20	Oct/26/2010	

Danfoss ECL Apex20

Website: <http://www.danfoss.com/>

HMI Setting:

Parameters	Recommend	Option	Notes
PLC type	Danfoss ECL Apex20		
PLC I/F	RS232		
Baud rate	9600		
Parity	None		
Data bits	8		
Stop bits	1		
PLC st. no.	1		

Device Address:

Bit/Word	Device type	Format	Range	Memo
B	Flag	DDDD	0 ~ 8191	
B	Input	DDDD	0 ~ 1023	
B	Output	DDDD	0 ~ 1023	
B	Reg_Bit	DDDDdd	0 ~ 1638331	dd: Bit no. (00~31)
W	Register	DDDDD	0 ~ 16383	
W	Counter	DDDD	0 ~ 1599	
W	Timer	DDDD	0 ~ 1599	
W	Reg_Float	DDDDD	0 ~ 16383	Support 32-bit float format

EasyBuilder device addresses range may different with PLC extended mode, please refer EasyBuilder's addresses range as above.

Wiring Diagram:

9P D-Sub to 9P D-Sub:

HMI COM1 RS232 9P D-Sub Male	HMI COM2 RS232 9P D-Sub Male	HMI COM3 RS232 9P D-Sub Female	ECL Apex20 Controller RS232 9P D-Sub Male	
2 RX	6 RX	8 RX	3 TXD	
3 TX	4 TX	7 TX	2 RXD	
5 GND	5 GND	5 GND	5 GND	
			7 RTS	circuit
			8 CTS	
				

HMI COM1 RS485 2W 9P D-Sub Female	HMI COM3 RS485 2W 9P D-Sub Female		ECL Apex20 Controller Port#1 / Port#0
1 RX-	6 Data-		11 / 29
2 RX+	9 Data+		12 / 28
5 GND	5 GND		

Driver Version:

Version	Date	Description
V1.30	Jan/10/2011	

Danfoss FC Series

Supported series: FC051, FC100, FC200, FC300, VLT Micro Driver.

Website: <http://www.danfoss.com/>

HMI Setting:

Parameters	Recommend	Option	Notes
PLC type	Danfoss FC Series		
PLC I/F	RS485 2W		
Baud rate	9600		
Parity	Even		
Data bits	8		
Stop bits	1		
PLC st. no.	1		

Device Address:

Bit/Word	Device type	Format	Range	Memo	
W	Parameter	09	DDDD	0 ~ 9999	Set Parameter
DW	Reference	10	D	0 ~ 1	Control Bus Reference
DW	Para_Index	11	DDDDDD	0 ~ 999999	Set Parameter(Index)

Para_Index 310.1=31001, Para_Index310.0=31000

Wiring Diagram:

HMI COM1 RS485 2W 9P D-Sub Female	HMI COM3 RS485 2W 9P D-Sub Female		FC RS485
1 RX-	6 Data-		69 D-
2 RX+	9 Data+		68 D+
5 GND	5 GND		

- *RW100 set PCD1 Control Word of station 1
- *RW101 read PCD1 Status Word of station 1
- *RW102 set PCD2 Control Word of station 2
- *RW103 read PCD2 Status Word of station 2
- *RW104 set PCD3 Control Word of station 3
- *RW105 read PCD3 Status Word of station 3
- *RW106 set PCD4 Control Word of station 4
- *RW107 read PCD4 Status Word of station 4

Driver Version:

Version	Date	Description
V1.10	Jan/14/2010	

Danfoss VLT2800 Series

Supported series: VLT2800 series

Website: <http://www.danfoss.com/>

HMI Setting:

Parameters	Recommend	Option	Notes
PLC type	Danfoss VLT2800 Series		
PLC I/F	RS485 2W		
Baud rate	9600		
Parity	Even		
Data bits	8		
Stop bits	1		
PLC st. no.	1	0-126	According to PLC

PLC Setting:

Communication mode	9600, Even, 8, 1 (default)
--------------------	----------------------------

Device Address:

Bit/Word	Device type	Format	Range	Memo
W	Reference	D	0 ~ 1	Control Bus Reference
DW	Parameter	DDDD	0 ~ 2000	Set Parameter

It is relate to station number, if station number is 1, control word is RW100 and RW101; if station number is 2, the control word is RW102 and RW103...following this rule.

Wiring Diagram:

HMI COM1 RS485 2W 9P D-Sub Female	HMI COM3 RS485 2W 9P D-Sub Female		VLT2800 RS485
1 RX-	6 Data-		69 D-
2 RX+	9 Data+		68 D+
5 GND	5 GND		

Driver Version:

Version	Date	Description
V1.10	Dec/30/2008	

DELTA DVP

Supported series: DELTA DVP series

Website: <http://www.deltadriver.com>

HMI Setting:

Parameters	Recommend	Option	Notes
PLC type	DELTA DVP		
PLC I/F	RS232	RS232, RS485	
Baud rate	9600	9600, 19200	
Parity	Even	Even, Odd, None	
Data bits	7	7, 8	
Stop bits	1	1	
PLC st. no.	1	0-255	

Device Address:

Bit/Word	Device type	Format	Range	Memo
B	X	OOOOO	0 ~ 23417 (octal)	Input
B	Y	OOOOO	0 ~ 23417 (octal)	Output
B	M	DDDDD	0 ~ 65536	Auxiliary Relay
B	S	DDDD	0 ~ 9999	Step Relay
B	T	DDDD	0 ~ 9999	Timer
B	C	DDDD	0 ~ 9999	Counter
B	TV_Bit	DDDDdd	0 ~ 999915	Timer
W	TV	DDDD	0 ~ 9999	Timer
W	CV	DDD	0 ~ 127	Counter
W	CV2	DDD	232 ~ 255	Double word counter
W	D	DDDD	0 ~ 9999	Data Register

Wiring Diagram:

9P D-Sub to 8P Mini-DIN:

HMI COM1 RS232 9P D-Sub Male	HMI COM2 RS232 9P D-Sub Male	HMI COM3 RS232 9P D-Sub Female	DELTA DVP CPU Port RS232 8P Mini-DIN
2 RX	6 RX	8 RX	5 TXD
3 TX	4 TX	7 TX	4 RXD
5 GND	5 GND	5 GND	3/8 GND



Driver Version:

Version	Date	Description
V1.00	Dec/30/2008	

Embedded PC (BECKHOFF)

HMI Setting:

Parameters	Recommend	Option	Notes
PLC type	Embedded PC (BECKHOFF)		
PLC I/F	Ethernet		
Port no.	48898		
PLC st. no.	1		

PLC Setting:

Step1.

Open the TwinCat System Properties

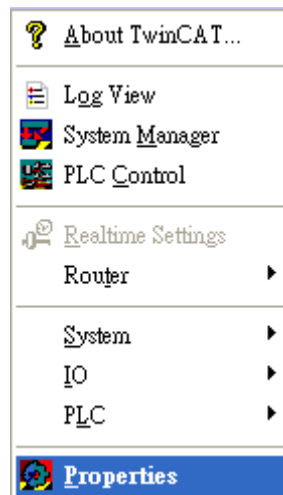

PLC Settings: set HMI Name, AMS Net ID, and Address on PLC.

Ex:

HMI IP: 192.168.1.15

AMSNetID: Must input 192.168.1.15.1.1

Address: 192.168.1.15

Name: Input "HMI" or any other desired name.

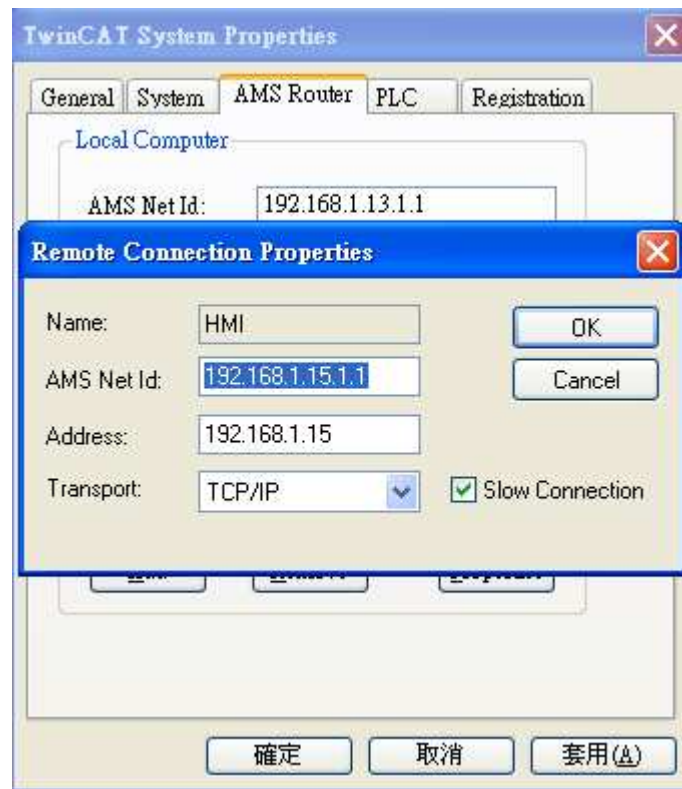

Step2.

Simulate PLC on PC. 2 Twincat drivers must be installed as follows:

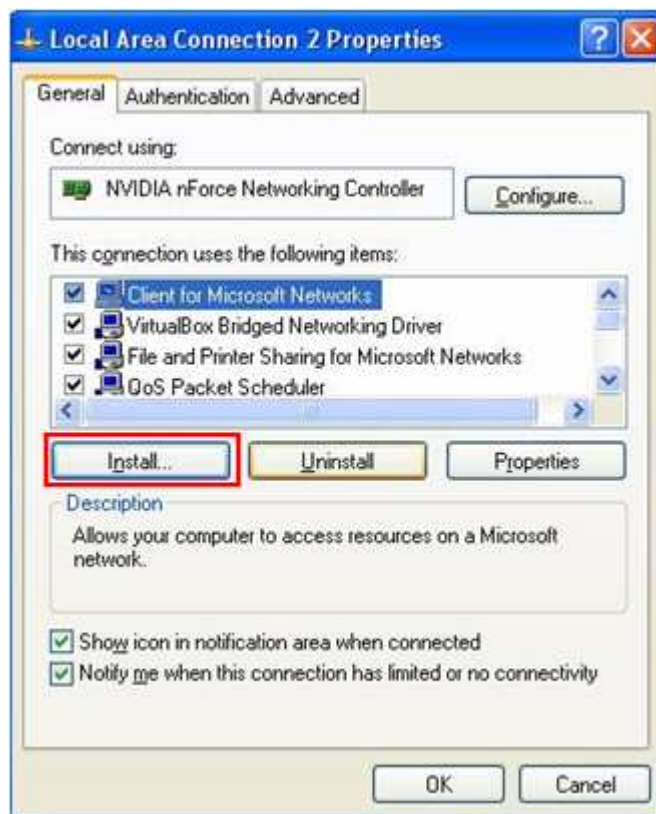

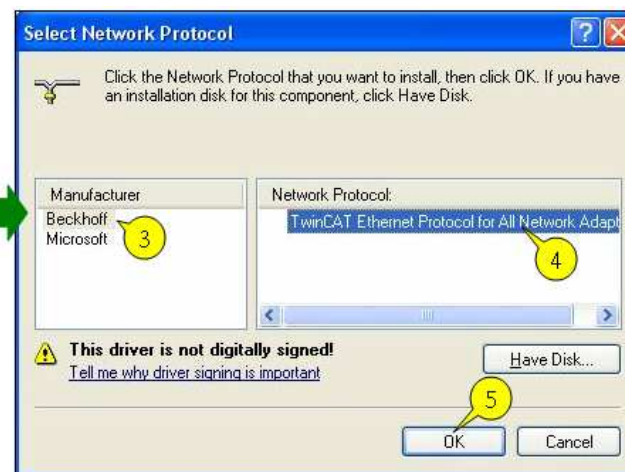
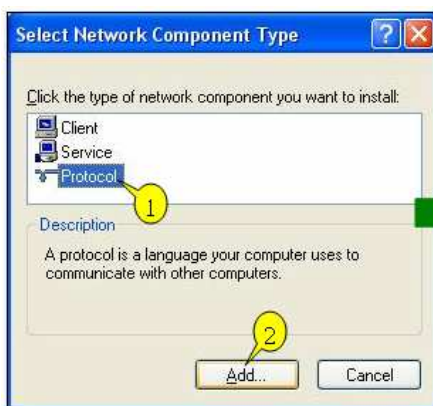
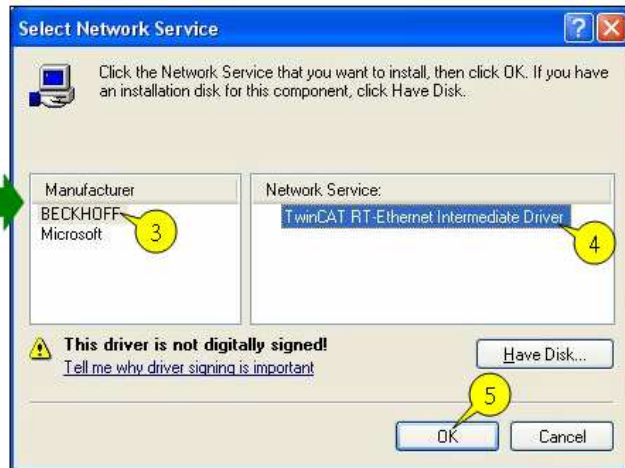
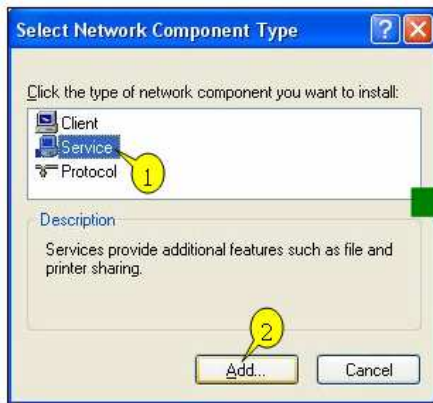

Step3.

The following commands can be utilized for Twincat PLC to output the parameters observed.

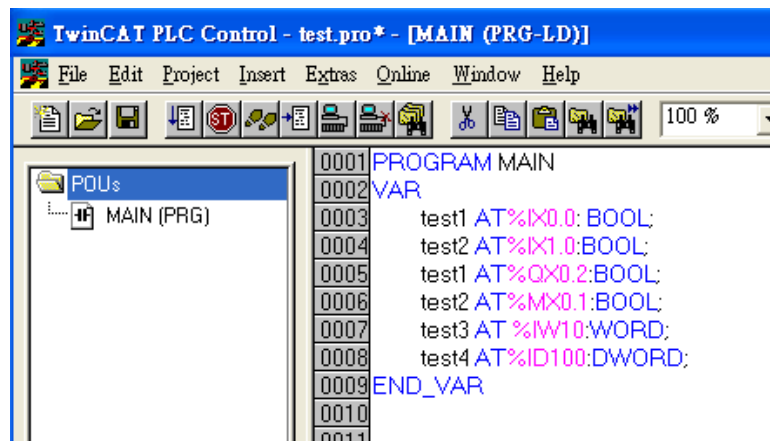
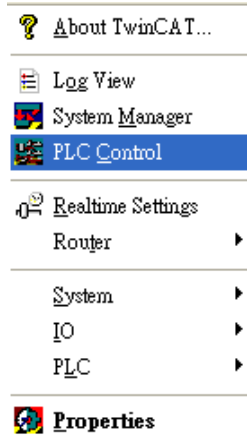

PS. Twincat PLC

IX, QX, MX - Must output in BOOL type.

IW, QW, MW - Must output in UINT, WORD, and INT types.

ID, QD, MD - Must output in UDINT, DWORD, and DINT types.

Project -> Rebuild all

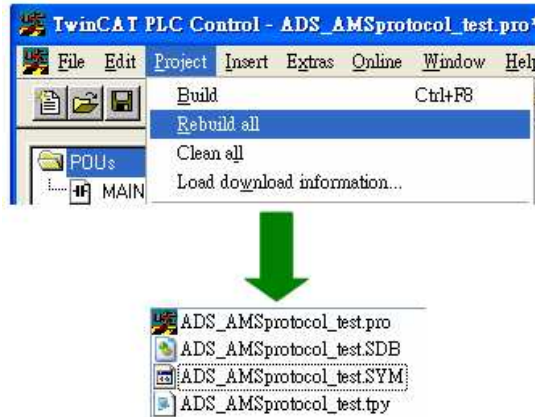

Step4.

Set PLC IP in EasyBuilder.

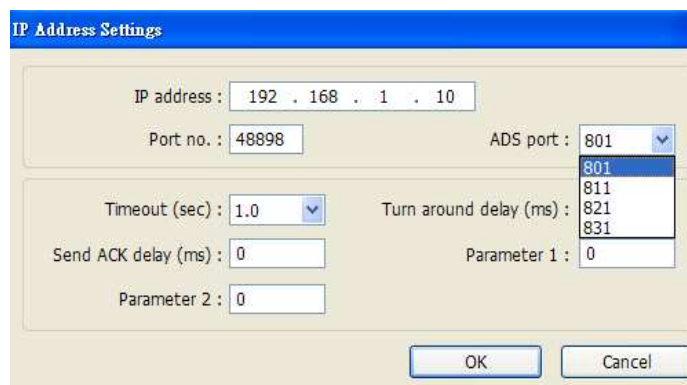
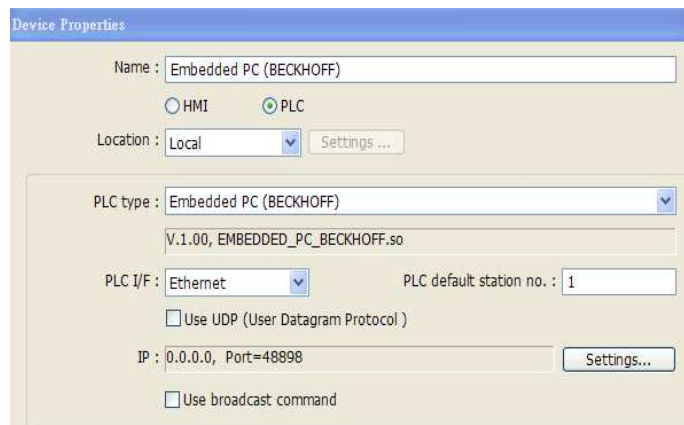

Step5.

Click [Import Tag] button in EasyBuilder to open the TPY file compiled by TwinCAT PLC Control.

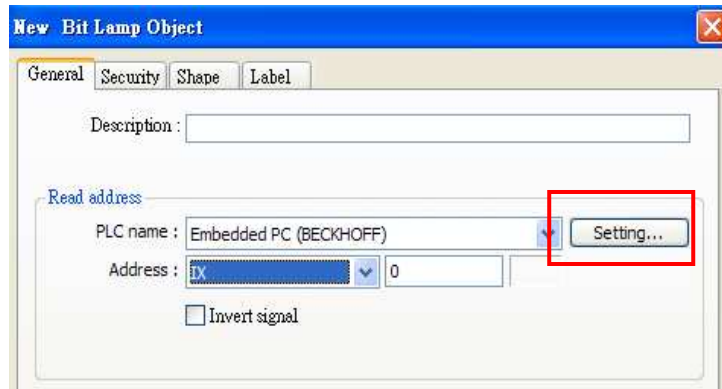
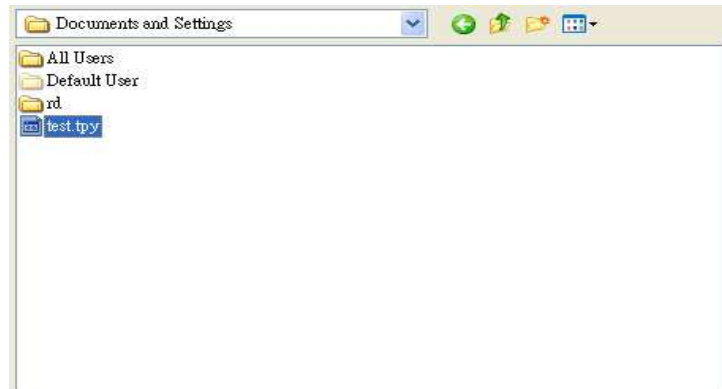
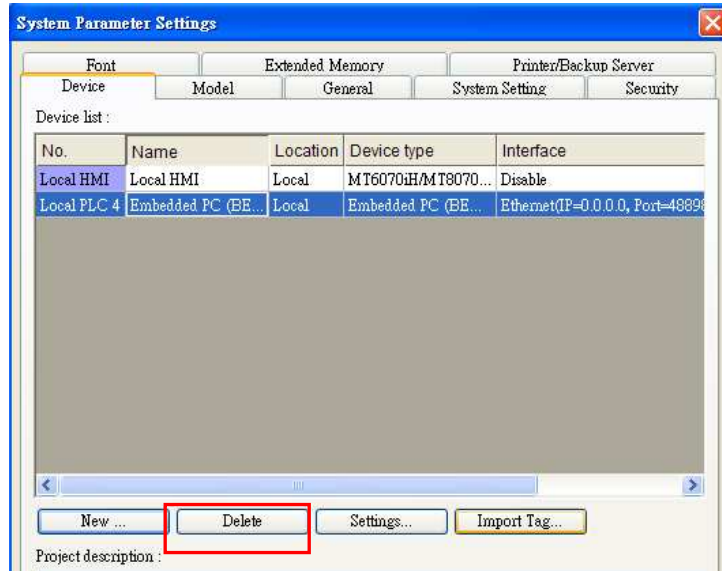

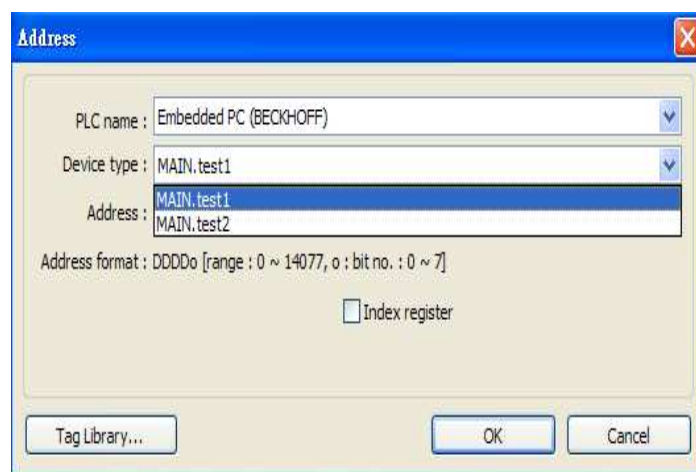
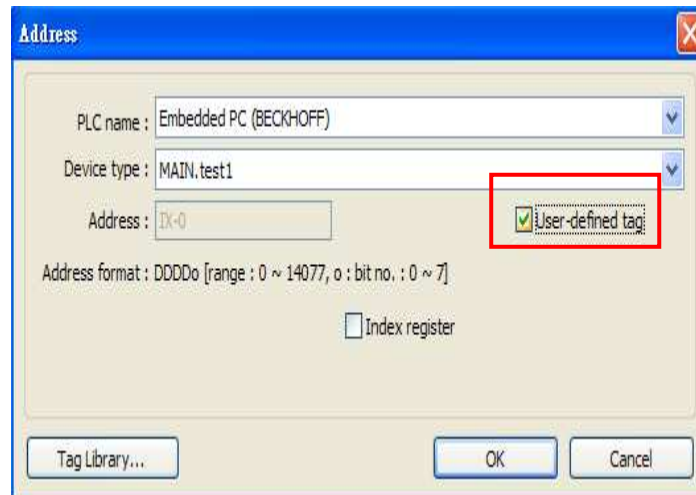

Step6.

Download the project compiled in EasyBuilder to HMI.

Device address:

Bit/Word	Device type	Format	Range	Memo
B	IX	DDDDDo	0 ~ 655357	o : Bit no.(0~7)
B	QX	DDDDDo	0 ~ 655357	o : Bit no.(0~7)
B	MX	DDDDDo	0 ~ 655357	o : Bit no.(0~7)
W	IW	DDDDD	0 ~ 65535	
W	QW	DDDDD	0 ~ 65535	
W	MW	DDDDD	0 ~ 65535	
DW	ID	DDDDDDDD	0 ~ 16777214	
DW	QD	DDDDDDDD	0 ~ 16777214	
DW	MD	DDDDDDDD	0 ~ 16777214	

Wiring Diagram:

Direct connect (crossover cable):

HMI RJ45 Female	Wire Color	PLC RJ45 Female
1 TX+	White/Orange	3 RX+
2 TX-	Orange	6 RX-
3 RX+	White/Green	1 TX+
4 BD4+	Blue	4 BD4+
5 BD4-	White/Blue	5 BD4-
6 RX-	Green	2 TX-
7 BD3+	White/Brown	7 BD3+
8 BD3-	Brown	8 BD3-



Through a hub:

HMI RJ45 Female	Wire Color	PLC RJ45 Female
1 TX+	White/Orange	1 TX+
2 TX-	Orange	2 TX-
3 RX+	White/Green	3 RX+
4 BD4+	Blue	4 BD4+
5 BD4-	White/Blue	5 BD4-
6 RX-	Green	6 RX-
7 BD3+	White/Brown	7 BD3+
8 BD3-	Brown	8 BD3-



Driver Version:

Version	Date	Description
V1.00	Dec/08/2010	Driver released.

EMERSON PLC EC20

Supported series: Emerson PLC EC20 Series. (Modbus RTU Protocol)

HMI Setting:

Parameters	Recommend	Option	Notes
PLC type	EMERSON PLC EC20		
PLC I/F	RS232		
Baud rate	9600	9600, 19200, 115200	
Parity	Even	Even, Odd, None	
Data bits	8	7 or 8	
Stop bits	1	1 or 2	
PLC st. no.	0	0-255	

PLC Setting:

Communication mode	Modbus RTU protocol
--------------------	---------------------

Device Address:

Bit/Word	Device type	Format	Range	Memo
B	Y	OOO	0 ~ 377 (octal) 256 point	0000-0255
B	X	OOO	0 ~ 377 (octal) 256 point	1200-01455 0000-0255
B	M	DDDD	0 ~ 1999	2000-3999
B	SM	DDD	0~ 255	4400-4655
B	S	DDD	0 ~ 991	6000-6991
B	T	DDD	0 ~ 255	8000-8255

B	C	DDD	0 ~ 255	9200-9455
W	D	DDDD	0 ~ 7999	0000-7999
W	SD	DDD	0 ~ 255	8000-8255
W	Z	DD	0 ~ 15	8500-8515
W	T	DDD	0 ~ 255	9000-9255
W	C	DDD	0 ~ 199	9500-9699
DW	C_Double	DDD	200 ~ 255	9700-9811
DW	D_Double	DDDD	0 ~ 7998	0000-7999

Wiring Diagram:

HMI COM1 RS232 9P D-Sub Male	HMI COM2 RS232 9P D-Sub Male	HMI COM3 RS232 9P D-Sub Female	Emerson EC20 COM1
2 RX	6 RX	8 RX	TXD
3 TX	4 TX	7 TX	RXD
5 GND	5 GND	5 GND	GND

Driver Version:

Version	Date	Description
V1.10	Dec/30/2008	

F930GOT Server

Supported series: F930GOT general-purpose communication Type 1.

HMI Setting:

Parameters	Recommend	Option	Notes
PLC type	F930GOT Server		
PLC I/F	RS232		
Baud rate	38400	9600, 115200	
Parity	None	Even, Odd, None	
Data bits	8	7 or 8	
Stop bits	1	1 or 2	
PLC st. no.	1		

Device Address:

Bit/Word	Device type	Format	Range	Memo
B	RB	DDDD	0 ~ 2047	
W	RW	DDDDD	0 ~ 65535	

Note: In PLC name pull down menu don't select F930GOT Server.
Please select Local HMI, Device type=RW.

Wiring Diagram:

9P D-Sub to 9P D-Sub:

HMI COM1 RS232 9P D-Sub Male	HMI COM2 RS232 9P D-Sub Male	HMI COM3 RS232 9P D-Sub Female	Micro Computer Board RS232
2 RX	6 RX	8 RX	TD
3 TX	4 TX	7 TX	RD
5 GND	5 GND	5 GND	GND



Protocol:

Read Command:

PC → HMI

02	'0'	Read address	Size	CR
----	-----	--------------	------	----

02	30	30	30	30	30	30	30	32	0D
----	----	----	----	----	----	----	----	----	----

Read RW0 1 word (2 bytes) STX = 0x02, '0' = Read command, CR = 0x0D

Read address (hexadecimal)

0 ~ FFFF = RW0 ~ 65535

Size (hexadecimal)

2 ~ FE = 2 ~ 254 bytes = 1 ~ 127 word.

Size must be even.

HMI → PC (response)

02	Data1	Data2	CR
----	-------	-------	-------	----

02	30	30	31	30	0D
----	----	----	----	----	----

RW0 = 0x0010 = 16

Write Command:

PC → HMI

02	'1'	Read address	Size	Data1	Data2	CR
----	-----	--------------	------	-------	-------	-------	----

02	31	30	30	30	30	30	32	12	34	0D
----	----	----	----	----	----	----	----	----	----	----

Write RW0 = 0x1234

Read address (hexadecimal)

0 ~ FFFF = RW0 ~ 65535

Size (hexadecimal)

2 ~ FE = 2 ~ 254 bytes = 1 ~ 127 word.

Size must be even.

HMI → PC (response)

06

ACK = 0x06

Driver Version:

Version	Date	Description
V1.00	Aug/14/2009	Driver released.

FATEK FB Series

Supported series: FATEK FBs series, FB MC series, and FB MA series need FB-DTBR converter.

Website: <http://www.fatek.com/>

HMI Setting:

Parameters	Recommend	Option	Notes
PLC type	FATEK FB Series		
PLC I/F	RS232	RS232/RS485 /Ethernet	
Baud rate	9600		
Parity	Even		
Data bits	7		
Stop bits	1		
PLC st. no.	1	0-255	Must match the PLC's port setting.

Device Address:

Bit/Word	Device type	Format	Range	Memo
B	X	DDDD	0 ~ 9999	Input
B	Y	DDDD	0 ~ 9999	Output
B	M	DDDD	0 ~ 9999	Internal Relay
B	S	DDDD	0 ~ 9999	Step Relay
B	T	DDDD	0 ~ 9999	Timer
B	C	DDDD	0 ~ 9999	Counter
B	PLC_MODE	D	0	PLC mode
W	R	DDDD	0 ~ 9999	Data Register
W	D	DDDD	0 ~ 9999	Data Register
W	RT	DDDD	0 ~ 9999	Timer Register
W	RC	DDDD	0 ~ 9999	Counter Register
W	DRT	DDDD	0 ~ 9999	Double word Timer Register
W	DRC	DDD	200 ~ 255	Double word Counter

				Register
W	WX	DDDD	0 ~ 9999	Input word
W	WY	DDDD	0 ~ 9999	Output word
W	WM	DDDD	0 ~ 9999	Internal Relay word

Wiring Diagram:

9P D-Sub to 4P Mini-DIN: FBs Port0

HMI COM1 RS232 9P D-Sub Male	HMI COM2 RS232 9P D-Sub Male	HMI COM3 RS232 9P D-Sub Female	FBs RS232 4P Mini-DIN
2 RX	6 RX	8 RX	3 TX
3 TX	4 TX	7 TX	4 RX
5 GND	5 GND	5 GND	2 GND



9P D-Sub to 9P D-Sub: FBs communication module

HMI COM1 RS232 9P D-Sub Male	HMI COM2 RS232 9P D-Sub Male	HMI COM3 RS232 9P D-Sub Female	FBs communication module RS232 9P D-Sub Male
2 RX	6 RX	8 RX	2 TX
3 TX	4 TX	7 TX	3 RX
5 GND	5 GND	5 GND	5 GND



FBs communication module 3P Terminal Block

HMI COM1 RS485 2W 9P D-Sub Female	HMI COM3 RS485 2W 9P D-Sub Female		FBs communication module 3P Terminal Block
1 RX-	6 Data-		D-
2 RX+	9 Data+		D+
5 GND	5 GND		

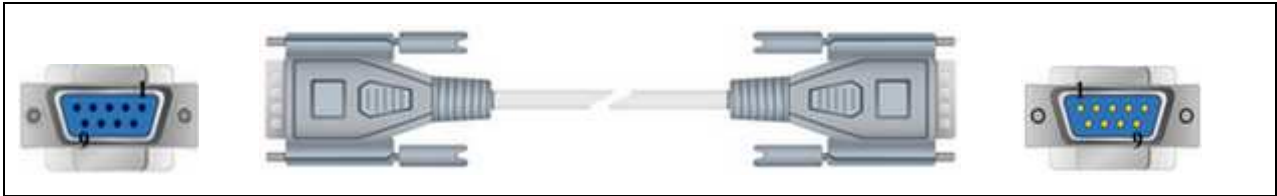
9P D-Sub to 15P D-Sub: CPU Port

HMI COM1 RS232 9P D-Sub Male	HMI COM2 RS232 9P D-Sub Male	HMI COM3 RS232 9P D-Sub Female	FB CPU Port RS232 15P D-Sub Male	
2 RX	6 RX	8 RX	2 TX	
3 TX	4 TX	7 TX	1 RX	
5 GND	5 GND	5 GND	6 GND	circuit
			3 RTS	
			4 CTS	

9P D-Sub to 15P D-Sub: CPU Port RS485 2W

HMI COM1 RS485 2W 9P D-Sub Female	HMI COM3 RS485 2W 9P D-Sub Female		FB CPU Port RS485 2W 15P D-Sub Male	
1 RX-	6 Data-		7 D-	
2 RX+	9 Data+		5 D+	
5 GND	5 GND			

Driver Version:

Version	Date	Description
V1.50	Jul/26/2010	

Fuji NB Series

Website: <http://www.fujielectric.co.jp/fcs/eng/>

HMI Setting:

Parameters	Recommend	Option	Notes
PLC type	Fuji NB Series		
PLC I/F	RS485 4W		
Baud rate	19200		
Parity	Odd		
Data bits	8		
Stop bits	1		
PLC st. no.	0		

PLC Setting:

Communication mode	NITP protocol / PLC Password (default is 0)
--------------------	---

Device Address:

Bit/Word	Device type	Format	Range	Memo
B	Y	HHH	0 ~ 7ff	Output Relay
B	X	HHH	0 ~ 3ff	Input Relay
B	M	HHH	0 ~ fff	Internal Relay
B	L	HHH	0 ~ fff	Latch Relay
B	C	HH	0 - ff	Counter
B	M_Spe	HHHH	0 ~ 81ff	Special Relay
B	T	HHH	0 ~ 1ff	Timer
W	CV	HHH	0 ~ 3ff	Counter value
W	TV	HHH	0 ~ 3ff	Timer value
W	D	HHHH	0 ~ 1fff	Data Register
W	D_Spe	HHHH	0 ~ 81ff	Special Register

Wiring Diagram:

9P D-Sub to 8P RJ45:

HMI COM1 RS485 4W 9P D-Sub Female			Fuji NB Series RS422 8P RJ45
1 RX-			4 TX-
2 RX+			3 TX+
3 TX-			6 RX-
4 TX+			5 RX+
5 GND			



Driver Version:

Version	Date	Description
V1.10	May/05/2009	

GE Fanuc CMM

Website: <http://www.ge.com>

HMI Setting:

Parameters	Recommend	Option	Notes
PLC type	GE Fanuc CMM		
PLC I/F	RS232	RS232/RS485	
Baud rate	19200	9600,19200,38400,57600,115200	
Parity	Odd	Even, Odd, None	
Data bits	8	7,8	Must set as 8 to this protocol
Stop bits	1	1, 2	
PLC st. no.	0	0-255	Does not apply to this protocol

PLC Setting:

Refer to related PLC manual.

Device Address:

Bit/Word	Device type	Format	Range	Memo
B	I	DDDDD	1 ~ 10000	Input relay
B	Q	DDDDD	1 ~ 10000	Output relay
B	M	DDDDD	1 ~ 10000	Auxiliary relay
B	G	DDDD	1 ~ 7680	
B	T	DDD	1 ~ 256	
B	SA	DDD	1 ~ 128	
B	SB	DDD	1 ~ 128	
B	SC	DDD	1 ~ 128	
B	S	DDD	1 ~ 128	
W	AI	DDDDD	1 ~ 10000	Analog input register
W	AQ	DDDDD	1 ~ 10000	Analog output register
W	R	DDDDD	1 ~ 32640	Data register

Wiring Diagram:

9P D-Sub to 15P D-Sub: CPU Port 90-30/VersaMax

HMI COM1 RS485 4W 9P D-Sub Male			90-30/VersaMax RS485 2W 15P D-Sub	
1 RX-			12 SDA	
2 RX+			13 SDB	
5 GND			7 GND	
3 TX-			10 RDA	
4 TX+			11 RDB	circuit
			9 RT	
			6 RTSA	circuit
			15 CTSA	
			8 RTSB	circuit
			14 CTSB	
				

9P D-Sub to 6P RJ11: CPU Port (90-30 series CPU351/352/363/364)

HMI COM1 RS232 9P D-Sub Female			90-30/90-70 series RS232 6P RJ11	
2 RX			2 TX	
3 TX			5 RX	
5 GND			3 GND	
				

9P D-Sub to 9P D-Sub: CPU Port (VersaMax series CPU001/002/005/E05)

HMI COM1 RS232 9P D-Sub Male	HMI COM2 RS232 9P D-Sub Male	HMI COM3 RS232 9P D-Sub Female	VersaMax series RS232 9P D-Sub Female
2 RX	6 RX	8 RX	2 TX
3 TX	4 TX	7 TX	3 RX
5 GND	5 GND	5 GND	5 GND
			

Driver Version:

Version	Date	Description
V1.00	Jul/09/2009	Driver released.

GE Fanuc RX3i

Website: <http://www.ge.com>

HMI Setting:

Parameters	Recommend	Option	Notes
PLC type	GE Fanuc RX3i		
PLC I/F	RS232	RS232, RS485	
Baud rate	19200	1200~115200	
Data bits	8		
Parity	Odd	None, Even, Odd	
Stop bits	1	1 or 2	
PLC st. no.	1	1~99	

PLC Setting:

Refer to related PLC manual.

Device Address:

Bit/Word	Device type	Format	Range	Memo
B	I	DDDDD	1 ~ 32768	
B	Q	DDDDD	1 ~ 32768	
B	M	DDDDD	1 ~ 32768	
B	G	DDDD	1 ~ 7680	
B	T	DDDD	1 ~ 1024	
B	SA	DDD	1 ~ 128	
B	SB	DDD	1 ~ 128	
B	SC	DDD	1 ~ 128	
B	S	DDD	1 ~ 128	
W	AI	DD	1 ~ 64	
W	AQ	DD	1 ~ 64	
W	R	DDDD	1 ~ 2048	

Wiring Diagram:

9P D-Sub to 9P D-Sub:

HMI COM1 RS232 9P D-Sub Male	HMI COM2 RS232 9P D-Sub Male	HMI COM3 RS232 9P D-Sub Female	GE Fanuc RX3i COM1 RS232 9P D-Sub Female	
2 RX	6 RX	8 RX	2 TXD	
3 TX	4 TX	7 TX	3 RXD	
5 GND	5 GND	5 GND	5 GND	
				

9P D-Sub to 15P D-Sub:

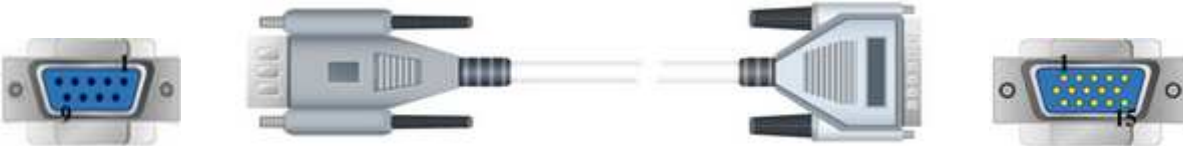
HMI COM1 RS485 4W 9P D-Sub Male			GE Fanuc RX3i COM2 RS422 15P D-Sub Female	
1 RX-			12 SDA	
2 RX+			13 SDB	
5 GND			7 GND	
3 TX-			10 RDA	
4 TX+			11 RDB	circuit
			9 RT	
			6 RTSA	circuit
			15 CTSA	
			8 RTSB	circuit
			14 CTSB	
				

Driver Version:

Version	Date	Description
V1.00	Oct/01/2010	Driver released.

GE Fanuc Series 90-30 (Ethernet)

Supported series: GE 90-30 series, CPU model 374plus.

HMI Setting:

Parameters	Recommend	Option	Notes
PLC type	GE Fanuc Series 90-30 (Ethernet)		
PLC I/F	Ethernet		
PLC st. no.	1	1~99	
Port no.	18245		

Device Address:

Bit/Word	Device type	Format	Range	Memo
B	I_bit	DDDDD	1 ~ 32768	
B	Q_bit	DDDDD	1 ~ 32768	
B	M_bit	DDDDD	1 ~ 32768	
B	G_bit	DDDDD	1 ~ 32768	
B	T_bit	DDDDD	1 ~ 32768	
B	SA_bit	DDDDD	1 ~ 32768	Read Only
B	SB_bit	DDDDD	1 ~ 32768	Read Only
B	SC_bit	DDDDD	1 ~ 32768	Read Only
B	S_bit	DDDDD	1 ~ 32768	Read Only
W	I	DDDDD	1 ~ 32753	Address increases 8 words, ex: I1, I9, I17, I25.....
W	Q	DDDDD	1 ~ 32753	the rule is same as above, ex:Q1, Q9, Q17...
W	M	DDDDD	1 ~ 32753	the rule is same as above, ex:M1, M9, M17..
W	G	DDDDD	1 ~ 32753	the rule is same as above, ex:G1, G9, G17...
W	T	DDDD	1 ~ 1024	the rule is same as above, ex:T1, T9, T17....
W	SA	DDDDD	1 ~ 32753	Read Only, the rule is same as above
W	SB	DDDDD	1 ~ 32753	Read Only, the rule is same

				as above
W	SC	DDDDD	1 ~ 32753	Read Only, the rule is same as above
W	S	DDDDD	1 ~ 32753	Read Only, the rule is same as above
W	R	DDDDD	1 ~ 32768	
W	AI	DDDDD	1 ~ 32768	
W	AQ	DDDDD	1 ~ 32768	

Wiring Diagram:

Direct connect (crossover cable):

HMI RJ45 Female	Wire Color	PLC RJ45 Female
1 TX+	White/Orange	3 RX+
2 TX-	Orange	6 RX-
3 RX+	White/Green	1 TX+
4 BD4+	Blue	4 BD4+
5 BD4-	White/Blue	5 BD4-
6 RX-	Green	2 TX-
7 BD3+	White/Brown	7 BD3+
8 BD3-	Brown	8 BD3-



Through a hub:

HMI RJ45 Female	Wire Color	PLC RJ45 Female
1 TX+	White/Orange	1 TX+
2 TX-	Orange	2 TX-
3 RX+	White/Green	3 RX+
4 BD4+	Blue	4 BD4+
5 BD4-	White/Blue	5 BD4-
6 RX-	Green	6 RX-
7 BD3+	White/Brown	7 BD3+
8 BD3-	Brown	8 BD3-



Driver Version:

Version	Date	Description
V1.70	Apr/09/2010	

GE Fanuc SNP-X

Supported series: GE Fanuc 90 & VersaMax series PLC

Website: <http://www.ge.com>

HMI Setting:

Parameters	Recommend	Option	Notes
PLC type	GE Fanuc SNP-X		
PLC I/F	RS485 4w	RS232/RS485	
Baud rate	19200	9600, 19200, 38400, 57600, 115200	
Parity	Odd	Even, Odd, None	
Data bits	8	7, 8	Must set as 8 to this protocol
Stop bits	1	1, 2	
PLC st. no.	0	0-255	Does not apply to this protocol

PLC Setting:

Refer to related PLC manual.

Device Address:

Bit/Word	Device type	Format	Range	Memo
B	I	DDDDD	1 ~ 10000	Input relay
B	Q	DDDDD	1 ~ 10000	Output relay
B	M	DDDDD	1 ~ 10000	Auxiliary relay
B	G	DDDD	1 ~ 7680	
B	T	DDD	1 ~ 256	
B	SA	DDD	1 ~ 128	
B	SB	DDD	1 ~ 128	
B	SC	DDD	1 ~ 128	
B	S	DDD	1 ~ 128	
W	AI	DDDDD	1 ~ 10000	Analog input register
W	AQ	DDDDD	1 ~ 10000	Analog output register

W	R	DDDDD	1 ~ 32640	Data register
---	---	-------	-----------	---------------

Wiring Diagram:

Memo: 90 VersaMax series PLC of GE FANUC includes such series as 90-30, 90-70, VersaMax Micro, VersaMax Nano and VersaMax,etc., CPU of 90-30series can pass RS485 serial com port on module, utilize SNP serial communication protocol of GE to connect with EasyView MT8000HMI, In addition, CPU331/340/341/350/351/352/360/363/364 can also connect through CMM311 Communication Module, CPU351/352/363/364 also can connect through serial com port on CPU Unit ; 90-70 series CPU can also connect through CMM711 Communication

Module or connect through serial com port on CPU Unit ; Relevant software and hardware are set up concretely please consult the technical manual that GE GE Fanuc offered.

9P D-Sub to 15P D-Sub: CPU Port (90-30/VersaMax)

HMI COM1 RS485 4W 9P D-Sub Male			90-30/VersaMax RS422 15P D-Sub Female	
1 RX-			12 SDA	
2 RX+			13 SDB	
5 GND			7 GND	
3 TX-			10 RDA	
4 TX+			11 RDB	circuit
			9 RT	
			6 RTSA	circuit
			15 CTSA	
			8 RTSB	circuit
			14 CTSB	
				

9P D-Sub to 6P RJ11: CPU Port (90-30 series CPU351/352/363/364)

HMI COM1 RS232 9P D-Sub Female			90-30/90-70 series RS232 6P RJ11
2 RX			2 TX
3 TX			5 RX
5 GND			3 GND
			

9P D-Sub to 9P D-Sub: CPU Port (VersaMax series CPU001/002/005/E05)

HMI COM1 RS232 9P D-Sub Male	HMI COM2 RS232 9P D-Sub Male	HMI COM3 RS232 9P D-Sub Female	VersaMax series RS232 9P D-Sub Female
2 RX	6 RX	8 RX	2 TX
3 TX	4 TX	7 TX	3 RX
5 GND	5 GND	5 GND	5 GND
			

Driver Version:

Version	Date	Description
V1.20	Jan/09/2009	

HanYoung Series

Supported series: Temperature Controller.

Website: <http://hynux.com/kor/>

HMI Setting:

Parameters	Recommend	Option	Notes
PLC type	Han Young Seires		
PLC I/F	RS485 4W		
Baud rate	9600		
Parity	None	Even, Odd, None	
Data bits	8	7 or 8	
Stop bits	1	1 or 2	
PLC st. no.	1	0-255	

Device Address:

Bit/Word	Device type	Format	Range	Memo
B	I	DDDD	1 ~ 9999	
W	D	DDDD	1 ~ 9999	

Wiring Diagram:

HMI COM1 RS485 4W 9P D-Sub Female			Han Young RS422
1 RX-			32 TX-
2 RX+			31 TX+
3 TX-			34 RX-
4 TX+			33 RX+
5 GND			

Driver Version:

Version	Date	Description
V1.60	Jun/14/2010	

Heng Yuan Sensor

Supported series : EU series, EU5 series, EU10 series.

Website : <http://www.hysensor.com.cn>

HMI Setting:

Parameters	Recommend	Option	Notes
PLC type	Heng Yuan Sensor		
PLC I/F	RS485 2W		
Baud rate	9600		
Parity	Even		
Data bits	8		
Stop bits	1		
PLC st. no.	2	1-31	

Online Simulator	YES	
Extend address mode	YES	

Device Address:

Bit/Word	Device type	Format	Range	Memo
W	Parameter	DDDD	0 ~ 2000	

Wiring Diagram:

9P D-Sub to 7P Mini-DIN: EU05 series

HMI COM1 RS485 2W 9P D-Sub Female	HMI COM3 RS485 2W 9P D-Sub Female		Heng Yuan Sensor RS485
1 RX-	6 Data-		7 RX- (Yellow)
2 RX+	9 Data+		6 RX+ (Green)
5 GND	5 GND		4 GND (Black)

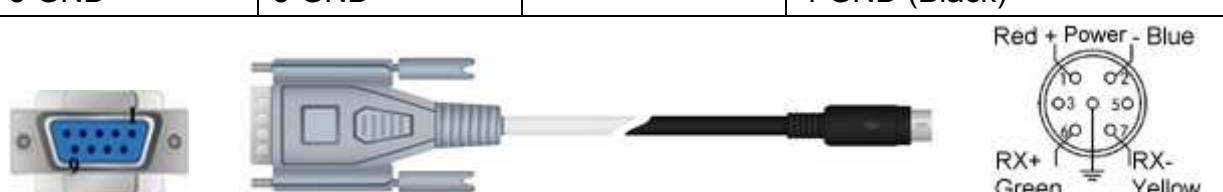

Driver Version:

Version	Date	Description
V1.00	Dec/30/2008	Driver released.

HITACHI EH-SIO

HMI Setting:

Parameters	Recommend	Option	Notes
PLC type	HITACHI EH-SIO		
PLC I/F	RS232	RS232, RS485	
Baud rate	19200	9600, 19200, 38400	
Parity	Even	Even	
Data bits	7	7	
Stop bits	1	1	
PLC st. no.	0		

PLC Setting:

Communication mode	19200, E, 7, 1 (default)
--------------------	--------------------------

Device Address:

Bit/Word	Device type	Format	Range	Memo
B	X	HHHHh	0 ~ ffff	External Input-bit(X)
B	Y	HHHHh	0 ~ ffff	External Output-bit(Y)
B	M	HHHHh	0 ~ ffff	Data area-bit(M)
B	T	HHHHh	0 ~ ffff	Timer(T)
B	R	HHHHh	0 ~ ffff	Internal Output(R)
B	L	HHHHh	0 ~ ffff	Link area-bit(L)
W	TC	HH	0 ~ ff	Timer/Counter current value
W	WX	HHHH	0 ~ 270f	External Input-word(X)
W	WY	HHHH	0 ~ 270f	External Output-word(Y)
W	WR	HHHH	0 ~ 270f	Internal Output-word(R)
W	WL	HHHH	0 ~ 270f	Link area-word(L)
W	WM	HHHH	0 ~ 270f	Data area-word(M)

Wiring Diagram:

9P D-Sub to 8P RJ45: EH-SIO port1/port 2 RS232

HMI COM1 RS232 9P D-Sub Male	HMI COM2 RS232 9P D-Sub Male	HMI COM3 RS232 9P D-Sub Female	HITACHI EH-SIO port1 / port2 RS232 8P RJ45	
2 RX	6 RX	8 RX	5 SD	
3 TX	4 TX	7 TX	6 RD	
5 GND	5 GND	5 GND	1 SG	
8 CTS			8 RS	
			4 PHL	circuit
			7 DR	
				

EH-SIO port2 RS485 4W

HMI COM1 RS485 4W 9P D-Sub Female			Hitachi EH-SIO
1 RX-			5 TX-
2 RX+			4 TX+
3 TX-			6 RX-
4 TX+			7 RX+
5 GND			1 SG

EH-SIO port2 RS485 4W

HMI COM1 RS485 4W 9P D-Sub Female			Hitachi EH-SIO	
1 RX-			5 TX-	circuit
3 TX-			6 RX-	
2 RX+			4 TX+	circuit
4 TX+			7 RX+	
5 GND			1 SG	

Driver Version:

Version	Date	Description
V1.00	May/25/2010	Driver released.

HITACHI EHV Series (Ethernet)

Website: <http://www.hitachi-ies.co.jp/english/products/plc/index.htm>

HMI Setting:

Parameters	recommend	Option	Notes
PLC type	HITACHI EHV Series (Ethernet)		
PLC I/F	Ethernet		
Port no.	3004	3004~3007	

Device Address:

Bit/Word	Device type	Format	Range	Memo
B	X	HHHHh	0 ~ ffff	External Input-bit(X)
B	Y	HHHHh	0 ~ ffff	External Output-bit(Y)
B	M	HHHHh	0 ~ ffff	Data area-bit(M)
B	T	DDDDD	0 ~ 65535	Timer(T)
B	R	HHHHh	0 ~ ffff	Internal Output(R)
B	L	HHHHh	0 ~ ffff	Link area-bit(L)
W	TC	DDDD	0 ~ 2559	Timer/Counter current value
W	WX	HHHH	0 ~ ffff	External Input-word(X)
W	WY	HHHH	0 ~ ffff	External Output-word(Y)
W	WR	HHHH	0 ~ ffff	Internal Output-word(R)
W	WL	HHHH	0 ~ 73ff	Link area-word(L)
W	WM	HHHH	0 ~ 7fff	Data area-word(M)

Wiring Diagram:

Direct connect (crossover cable):

HMI RJ45 Female	Wire Color	PLC RJ45 Female
1 TX+	White/Orange	3 RX+
2 TX-	Orange	6 RX-
3 RX+	White/Green	1 TX+
4 BD4+	Blue	4 BD4+
5 BD4-	White/Blue	5 BD4-
6 RX-	Green	2 TX-
7 BD3+	White/Brown	7 BD3+
8 BD3-	Brown	8 BD3-



Through a hub:

HMI RJ45 Female	Wire Color	PLC RJ45 Female
1 TX+	White/Orange	1 TX+
2 TX-	Orange	2 TX-
3 RX+	White/Green	3 RX+
4 BD4+	Blue	4 BD4+
5 BD4-	White/Blue	5 BD4-
6 RX-	Green	6 RX-
7 BD3+	White/Brown	7 BD3+
8 BD3-	Brown	8 BD3-



Driver Version:

Version	Date	Description
V1.00	Jan/12/2010	Driver released

HITACHI H/EH/EHV Series

Supported series: HITACHI H series, EH-150, Micro-EH, H20, H40, H64, H200, H250, H252, H300, H302, H700, H702, H1000, H1002, H2000, H4010.

Website: <http://www.hitachi-ies.co.jp/english/products/plc/index.htm>

HMI Setting:

Parameters	Recommend	Option	Notes
PLC type	HITACHI H/EH/EHV Series		
PLC I/F	RS232	RS232, RS485	
Baud rate	19200	9600, 19200, 38400	
Parity	Even	Even	
Data bits	7	7	
Stop bits	1	1	
PLC st. no.	0	0-255	Does not apply to this protocol.

Online Simulator	YES	Broadcast command	NO
Extend address mode	NO		

PLC Setting:

Communication mode	19200,E,7,1 (default)
--------------------	-----------------------

Device Address:

Bit/Word	Device type	Format	Range	Memo
B	X	HHHHh	0 ~ ffff	External Input-bit(X)
B	Y	HHHHh	0 ~ ffff	External Output-bit(Y)
B	M	HHHHh	0 ~ ffff	Data area-bit(M)
B	T	HHHHh	0 ~ ffff	Timer(T)
B	R	HHHHh	0 ~ ffff	Internal Output(R)
B	L	HHHHh	0 ~ ffff	Link area-bit(L)
W	TC	HH	0 ~ ff	Timer/Counter current value

W	WX	HHHH	0 ~ 270f	External Input-word(X)
W	WY	HHHH	0 ~ 270f	External Output-word(Y)
W	WR	HHHH	0 ~ 270f	Internal Output-word(R)
W	WL	HHHH	0 ~ 270f	Link area-word(L)
W	WM	HHHH	0 ~ 270f	Data area-word(M)

Wiring Diagram:

WARNING: If your communications cable is not wired exactly as shown in our cable assembly instructions, damage to the HMI or loss of communications can result.

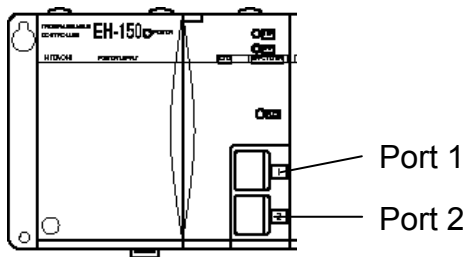

CPU TYPE	Port 1	Port 2
EH-150/CPU 104A	RS-232	RS-232
EH-150/CPU 208A	RS-232	RS-232
EH-150/CPU 308A	RS-232/RS-485	RS-232
EH-150/CPU 316A	RS-232/RS-485	RS-232
EH-150/CPU 448A	RS-232/RS-485	RS-232

Switch Number				
1	OFF	Normal mode		
2	OFF	TRNS0 operation		
3, 4	3	4	Port1 transmission speed	
	ON	ON	4,800 bps	Doesn't support
	OFF	ON	9,600 bps	
	ON	OFF	19,200 bps	Default
	OFF	OFF	38,400 bps	
5	ON	Dedicated port		
6	6	PHL	Port2 transmission speed	
	ON	Low	9,600 bps	
	ON	High	38,400 bps	
	OFF	Low	4,800 bps	Doesn't support
	OFF	High	19,200 bps	Default
7	OFF	(System mode)		Do not turn on.
8	OFF	(System mode)		Do not turn on.

Port setting toggle-switch

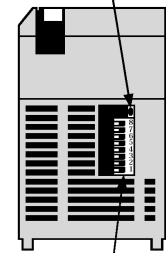

Mode setting DIP-switch

Toggle-Switch

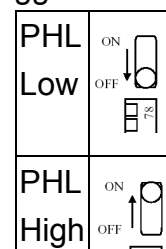

9P D-Sub to 8P RJ45: EH-150 port1/port 2 RS232 / MICRO-EH port1 RS232

HMI COM1 RS232 9P D-Sub Male	HMI COM2 RS232 9P D-Sub Male	HMI COM3 RS232 9P D-Sub Female	HITACHI EH-150 port1 / port2 RS232 8P RJ45	
2 RX	6 RX	8 RX	5 SD	
3 TX	4 TX	7 TX	6 RD	
5 GND	5 GND	5 GND	1 SG	
8 CTS			8 RS	
			4 PHL	circuit
			7 DR	

EH-150 port1 RS485 4W

HMI COM1 RS485 4W 9P D-Sub Female			Hitachi EH-150 Port1 8P RJ45	
1 RX-			5 TX-	
2 RX+			4 TX+	
3 TX-			6 RX-	
4 TX+			7 RX+	
5 GND			1 SG	
				

EH-150 port1 RS485 4W

HMI COM1 RS485 4W 9P D-Sub Female			Hitachi EH-150 Port1 8P RJ45	
1 RX-			5 TX-	circuit
3 TX-			6 RX-	
2 RX+			4 TX+	circuit
4 TX+			7 RX+	
5 GND			1 SG	
				

9P D-Sub to 15P D-Sub: H Series CPU Port RS232

HMI COM1 RS232 9P D-Sub Male			Hitachi H series CPU RS232 15P D-Sub	
2 RX			2 TXD	
3 TX			3 RXD	
5 GND			9 SG	Circuit
			10 SG	
8 CTS			4 RTS	
			5 CTS	Circuit
			7 DSR	
			8 PHL	Circuit
			14 PV12	
				

Driver Version:

Version	Date	Description
V1.10	Oct/22/2009	Fixed HMI occupies the control right of CPU module
V1.20	Mar/22/2010	

HUST H4X

Supported series: HUST CNC Controller H4 Series.

Website: <http://www.hust.com.tw/>

HMI Setting:

Parameters	Recommend	Option	Notes
PLC type	HUST H4X		
PLC I/F	RS-232		CPU port
PLC st. no.	1		
Baud rate	38400	9600,19200,38400,57600	
Data bits	7		
Parity	Even		
Stop bits	2		
Turn delay	5		

Device Address:

Bit/Word	Device type	Format	Range	Memo
B	I	DDD	0 ~ 255	Mapping to VM 10800 ~ 10807 (read only)
B	O	DDD	0 ~ 255	Mapping to VM 10808 ~ 10815 (read only)
B	C	DDD	0 ~ 255	Mapping to VM 10816 ~ 10823 (read only)
B	S	DDD	0 ~ 255	Mapping to VM 10824 ~ 10831 (read only)
B	A	DDD	0 ~ 255	Mapping to VM 10832 ~ 10863 (read only)
B	VM_bit	DDDDDDdd	1 ~ 99999(31)	Bit address (dd): 00~31
DW	VM	DDDDDD	1 ~ 99999	Please refer to specification of Controller for registers range.
DW	R	DDD	0 ~ 255	Mapping to VM 10000~10255 (read only)
DW	Cn	DDD	0 ~ 255	Mapping to VM 10256~10511

				(read only)
DW	Tm	DDD	0 ~ 255	Mapping to VM 10512~10767 (read only)

Wiring Diagram:

HMI COM1 RS232 9P D-Sub Male	HMI COM2 RS232 9P D-Sub Male	HMI COM3 RS232 9P D-Sub Female	HUST CNC Controller RS232
2 RX	6 RX	8 RX	TXD
3 TX	4 TX	7 TX	RXD
5 GND	5 GND	5 GND	GND

Driver Version:

Version	Date	Description
V2.01	Sep/29/2009	

IAI X-SEL CONTROLLER

Website: <http://www.iai-robot.co.jp/>

HMI Setting:

Parameters	Recommend	Option	Notes
PLC type	IAI X-SEL CONTROLLER		
PLC I/F	RS232		
Baud rate	9600	9600~19200	
Parity	None	Even, Odd, None	
Data bits	7	7 or 8	
Stop bits	1	1 or 2	
PLC st. no.	0		

Device Address:

Bit/Word	Device type	Format	Range	Memo
W	Servo_On_Off	H	1~8	Address 1~8 represent the corresponding axis. Write 1 means ON and 0 means OFF.
W	Servo_Origin	H	1~8	Address 1~8 represent the corresponding axis. Back to origin.
W	RunProgram	H	0	Data written indicates which program to run.
W	EndProgram	H	0	Data written indicates which program to stop.
W	SoftWareReset	H	0	Reset soft ware.
W	CurrentAxisPos	H	1~8	For reading current position. The state of current axis is put in RW axis*100. i.e., for the state of axis 2, 2*100=200, so it is in RW200.
W	PointMove	H	0~8	Address 1~8 represent the corresponding axis. The data written indicates which point to reach. Put

				parameters ACC, DEC, SPEED in axis*100+1, axis*100+2 and axis*100+3 respectively.
W	JoggingMove	H	0~8	Jogging. Address 1~8 represent the corresponding axis. Put parameters ACC, DEC, SPEED and Position in axis*100+11, axis*100+12, axis*100+13 and axis*100+14 respectively.
W	AbsoluteMove	H	0~8	Jog to the set absolute coordinate. Address 1~8 represent the corresponding axis. Put parameters ACC, DEC, SPEED and Position in axis*100+21, axis*100+22, axis*100+23 and axis*100+24 respectively.
W	PointChange	H	0~8	To change the value of the point. Address 1~8 represent the corresponding axis. Put parameters ACC, DEC, SPEED and Position in axis*100+31, axis*100+32, axis*100+33 and axis*100+34 respectively.

Note: ddd: Decimal, hhh: Hexadecimal, ooo: Octal.

Every model of CPU is different; we suggest user to refer to PLC manual's Device List.

Wiring Diagram:

HMI COM1 RS232 9P D-Sub Male	HMI COM2 RS232 9P D-Sub Male	HMI COM3 RS232 9P D-Sub Female	Host RS232
2 RX	6 RX	8 RX	TX
3 TX	4 TX	7 TX	RX
5 GND	5 GND	5 GND	GND



Driver Version:

Version	Date	Description
V1.00	Jun/01/2010	Driver released

IDEC Micro

Supported series: IDEC Micro3, Micro3C, MicroSmart, OpenNet Controller series.

Website: <http://www.idec.com>

HMI Setting:

Parameters	Recommend	Option	Notes
PLC type	IDEC Micro		
PLC I/F	RS232	RS232, RS485	
Baud rate	9600	9600, 19200	
Parity	Even	Even, Odd, None	
Data bits	7	7, 8	
Stop bits	1	1	
PLC st. no.	255 (for 1:1 connect)	0-255	255 or same as the PLC setting

Online Simulator	YES	
Extend address mode	YES	Don't set the PLC Station No.= 255

PLC Setting:

Communication mode	9600, E, 7, 1 (default), Use Computer Link Protocol
--------------------	---

Device Address:

Bit/Word	Device type	Format	Range	Memo
B	X	DDDDo	0 ~ 20477	Input(I)
B	Y	DDDDo	0 ~ 20477	Output(Q)
B	M	DDDDo	0 ~ 20477	Internal Relay(M)
W	RT	DDDD	0 ~ 9999	Timer(T)
W	RC	DDDD	0 ~ 9999	Counter(C)
W	D	DDDD	0 ~ 9999	Data Register(D)

Wiring Diagram:

9P D-Sub to 8P Mini-DIN: Micro3C, MicroSmart, OpenNet Controller CPU Ladder Port

HMI COM1 RS232 9P D-Sub Male	HMI COM2 RS232 9P D-Sub Male	HMI COM3 RS232 9P D-Sub Female	CPU Port1 or Port2 RS232 8P Mini-DIN
2 RX	6 RX	8 RX	3 TXD
3 TX	4 TX	7 TX	4 RXD
5 GND	5 GND	5 GND	7 GND
			

9P D-Sub to 8P Mini-DIN: Micro3 CPU Port, MicroSmart with FC4A-PC2 RS485
Communication Adapter

HMI COM1 RS485 2W 9P D-Sub Male	HMI COM3 RS485 2W 9P D-Sub Male		CPU Port RS485 8P Mini-DIN
1 RX-	6 Data-		2 RXD-
2 RX+	9 Data+		1 RXD+
5 GND	5 GND		7 GND
			

9P D-Sub to Terminals: Micro3C, OpenNet Controller Data Link Terminals,
MicroSmart with FC4A-PC3 RS485 Communication Adapter

HMI COM1 RS485 2W 9P D-Sub Male	HMI COM3 RS485 2W 9P D-Sub Male		Data Link Terminals
1 RX-	6 Data-		A RXD-
2 RX+	9 Data+		B RXD+
5 GND	5 GND		SG GND
			

Driver Version:

Version	Date	Description
V1.20	Jun/19/2009	

INOVANCE H2U/H1U

Website: <http://www.inovance.cn/>

HMI Setting:

Parameters	Recommend	Option	Notes
PLC type	INOVANCE H2U/H1U		
PLC I/F	RS485 4W		
Baud rate	9600	9600~19200	
Parity	Even	Even, Odd, None	
Data bits	7	7 or 8	
Stop bits	1	1 or 2	
PLC st. no.	0		

Device Address:

Bit/Word	Device type	Format	Range	Memo
B	X	OOO	0 ~ 377	Input Bits
B	Y	OOO	0 ~ 377	Output Bits
B	M	DDDD	0 ~ 7999	Auxiliary Relay
B	SM	DDDD	8000 ~ 9999	Special Auxiliary Relay
B	T	DDD	0 ~ 255	Timer Relay
B	C	DDD	0 ~ 255	Counter Relay
B	D_Bit	DDDDdd	0 ~ 799915	
B	S	DDDD	0 ~ 4095	
W	TV	DDD	0 ~ 255	Timer Memory
W	CV	DDD	0 ~ 199	Counter Memory
DW	CV2	DDD	200 ~ 255	Counter Memory (32bit)
W	D	DDDD	0 ~ 7999	Data Registers
W	SD	DDDD	8000 ~ 9999	Special Data Register

Note: ddd: Decimal, hhh: Hexadecimal, ooo: Octal.

Every model of CPU is different, and we suggest user to refer to PLC manual's Device List.

Wiring Diagram:

9P D-Sub to 8P MiniDIN:

HMI COM1 RS485 4W 9P D-Sub Male			H2U/H1U RS422 8P Mini-DIN
1 RX-			4 TX-
2 RX+			7 TX+
3 TX-			1 RX-
4 TX+			2 RX+
5 GND			3 GND



Driver Version:

Version	Date	Description
V1.00	May/19/2010	Driver released.

Intelligent Servo

Supported series: Intelligent Servo supports IDM640, IDM240.

Website: <http://www.techsoftmotion.com>

HMI Setting:

Parameters	Recommend	Option	Notes
PLC type	Intelligent Servo		
PLC I/F	RS232		
Baud rate	9600	9600~115200	
Parity	None	Even, Odd, None	
Data bits	8	7 or 8	
Stop bits	1	1 or 2	
PLC st. no.	1		

Device Address:

Bit/Word	Device type	Format	Range	Memo
W	Register_32bit	HHHH	0 ~ 270f	32bit signed
DW	Register_H	HHHH	0 ~ 270f	32bit Hex
W	UPD	HHHHH	0 ~ 1869f	Send UDP command
W	STOP	HHHHH	0 ~ 1869f	Send STOP command

Wiring Diagram:

HMI COM1 RS232 9P D-Sub Male	HMI COM2 RS232 9P D-Sub Male	HMI COM3 RS232 9P D-Sub Female	Servo RS232
2 RX	6 RX	8 RX	2 TD
3 TX	4 TX	7 TX	3 RD
5 GND	5 GND	5 GND	5 GND

Driver Version:

Version	Date	Description
V1.00	Nov/06/2009	Driver released.

Justfi controller

Supported series: Justfi weighing instruments, Industrial Batching Controller supports XK31CB4, XK31CB6.

Website: <http://www.justfi.com>

HMI Setting:

Parameters	Recommend	Option	Notes
PLC type	Justfi controller		
PLC I/F	RS232		
Baud rate	9600	9600, 19200	
Parity	Even	Even, Odd, None	
Data bits	7	7 or 8	
Stop bits	1	1 or 2	
PLC st. no.	1		

Device Address:

Bit/Word	Device type	Format	Range	Memo
W	Func	DD	0 ~ 99	Read/Write
DW	Func_DW	DD	0 ~ 99	Read/Write
W	RW	H	0	Weight (Read only)
W	RF	H	0	Read result (Read only)
W	RT	H	0	Read total (Read only)
W	RG	H	0	Read prescription group
W	RC	H	0	Circle
W	RB	H	0	Read Status (Read only)
W	MZ	H	0	Zero (Write only)
W	MT	H	0	Tare (Write only)
W	CT	H	0	Clear tare (Write only)
W	DT	H	0	Clear total (Write only)
W	BB	H	0	Start (Write only)
W	HB	H	0	Stop (Write only)
W	BD	H	0	Discharge (Write only)
W	RP1t RP6F	H	0	Read/Write Recipe

Wiring Diagram:

HMI COM1 RS232 9P D-Sub Male	HMI COM2 RS232 9P D-Sub Male	HMI COM3 RS232 9P D-Sub Female	CB4 RS232
2 RX	6 RX	8 RX	TD
3 TX	4 TX	7 TX	RD
5 GND	5 GND	5 GND	GND

Driver Version:

Version	Date	Description
V1.40	Nov/04/2009	

Kernel sistemi

Supported series: Kernel sistemi DMX 30

Website: <http://www.kernel.modena.it/>

HMI Setting:

Parameters	Recommend	Option	Notes
PLC type	Kernel sistemi		
PLC I/F	RS232	RS485	
Baud rate	19200	9600	
Parity	None		
Data bits	8		
Stop bits	1		
PLC st. no.	1		Must match the PLC's port setting

Device Address:

Bit/Word	Device type	Format	Range	Memo
W	D	HHHH	0 ~ ffff	

Wiring Diagram:

9P D-Sub to 9P D-Sub:

HMI COM1 RS232 9P D-Sub Male	HMI COM2 RS232 9P D-Sub Male	HMI COM3 RS232 9P D-Sub Female	DMX30 RS232 9P D-Sub Female
2 RX	6 RX	8 RX	3 TX
3 TX	4 TX	7 TX	2 RX
5 GND	5 GND	5 GND	5 GND



Driver Version:

Version	Date	Description
V1.00	Feb/06/2010	Driver released.

KEYENCE KV-10/16/24/40/80/Visual KV Series

Supported series: KEYENCE KV series, KV16~80

Website: <http://www.keyence.com/>

HMI Setting:

Parameters	Recommend	Option	Notes
PLC type	KEYENCE KV-10/16/24/40/80/Visual KV Series		
PLC I/F	RS232	RS232	
Baud rate	9600		
Parity	Even		
Data bits	8		
Stop bits	1		
PLC st. no.	0		Must match the PLC's port setting.

Device Address:

Bit/Word	Device type	Format	Range	Memo
B	RLY	DDDdd0*	0 ~ 655150*	bb:0~15
B	DM_Bit	DDDDh	0 ~ 65535f	
W	DM	DDDD	0 ~ 65535	
W	TM	DDDD	0 ~ 8999	
W	T	DDDD	0 ~ 9999	
W	T_Curr	DDDD	0 ~ 9999	Timer_Current
W	T_Preset	DDDD	0 ~ 9999	
W	C	DDDD	0 ~ 9999	
W	C_Curr	DDDD	0 ~ 9999	Counter_Current
W	C_Preset	DDDD	0 ~ 9999	

Precaution:*

If you use the Relay(bit) register, Please place zero behind address.

For example, If you want to read Relay(bit)100, you just set the address as "1000".

Wiring Diagram:

RS232 CPU Port:

HMI COM1 RS232 9P D-Sub Male	HMI COM2 RS232 9P D-Sub Male	HMI COM3 RS232 9P D-Sub Female	KEYENCE PLC OP-26486
2 RX	6 RX	8 RX	3 TXD
3 TX	4 TX	7 TX	2 RXD
5 GND	5 GND	5 GND	5 GND

9P D-Sub to 6P RJ11:

HMI COM1 RS232 9P D-Sub Female	HMI COM2 RS232 9P D-Sub Female	HMI COM3 RS232 9P D-Sub Male	KEYENCE PLC RS232 6P RJ11
2 RX	6 RX	8 RX	2 TXD
3 TX	4 TX	7 TX	4 RXD
5 GND	5 GND	5 GND	3 GND
			

Driver Version:

Version	Date	Description
V1.40	Apr/17/2009	

KEYENCE KV-5000 (Ethernet)

Website: <http://www.keyence.com/>

HMI Setting:

Parameters	Recommend	Option	Notes
PLC type	KEYENCE KV-5000 (Ethernet)		
PLC I/F	Ethernet		
Port no.	8501		Must match the PLC's port setting.
PLC st. no.	0		Must match the PLC's port setting.

Device Address:

Bit/Word	Device type	Format	Range	Memo
B	RLY	DDDdd	0 ~ 99915	
B	MR	DDDdd	0 ~ 99915	
B	LR	DDDdd	0 ~ 99915	
B	CR	DDDdd	0 ~ 99915	
W	DM	DDDDD	0 ~ 65535	
W	TM	DDDD	0 ~ 9999	
W	CM	DDDDD	0 ~ 65535	
W	EM	DDDDD	0 ~ 65535	
W	FM	DDDDD	0 ~ 65535	
W	T	DDDD	0 ~ 9999	
W	T_Curr	DDDD	0 ~ 9999	Timer Current
W	T_Preset	DDDD	0 ~ 9999	Timer Preset
W	C	DDDD	0 ~ 9999	
W	C_Curr	DDDD	0 ~ 9999	
W	C_Preset	DDDD	0 ~ 9999	

Precaution:

If you use the RLY(bit) register, Please place zero behind address.

For example, if you want to read RLY 100, you just set the address as "1000".

Wiring Diagram:

Direct connect (crossover cable):

HMI RJ45 Female	Wire Color	PLC RJ45 Female
1 TX+	White/Orange	3 RX+
2 TX-	Orange	6 RX-
3 RX+	White/Green	1 TX+
4 BD4+	Blue	4 BD4+
5 BD4-	White/Blue	5 BD4-
6 RX-	Green	2 TX-
7 BD3+	White/Brown	7 BD3+
8 BD3-	Brown	8 BD3-



Through a hub:

HMI RJ45 Female	Wire Color	PLC RJ45 Female
1 TX+	White/Orange	1 TX+
2 TX-	Orange	2 TX-
3 RX+	White/Green	3 RX+
4 BD4+	Blue	4 BD4+
5 BD4-	White/Blue	5 BD4-
6 RX-	Green	6 RX-
7 BD3+	White/Brown	7 BD3+
8 BD3-	Brown	8 BD3-



Driver Version:

Version	Date	Description
V1.00	Dec/25/2009	Driver released.

KEYENCE KV-700/1000/3000/5000 Series

Website: <http://www.keyence.com/>

HMI Setting:

Parameters	Recommend	Option	Notes
PLC type	KEYENCE KV-700/1000/3000/5000 Series		
PLC I/F	RS232	RS232	
Baud rate	115200		
Parity	Even		
Data bits	8		
Stop bits	1		
PLC st. no.	0		Must match the PLC's port setting.

Device Address:

Bit/Word	Device type	Format	Range	Memo
B	RLY	DDDdd	0 ~ 99915	
B	MR	DDDdd	0 ~ 99915	
B	LR	DDDdd	0 ~ 99915	
B	CR	DDDdd	0 ~ 99915	
W	DM	DDDDD	0 ~ 65535	
W	TM	DDDD	0 ~ 9999	
W	CM	DDDDD	0 ~ 65535	
W	EM	DDDDD	0 ~ 65535	
W	FM	DDDDD	0 ~ 65535	
W	T	DDDD	0 ~ 9999	
W	T_Curr	DDDD	0 ~ 9999	Timer_Current
W	T_Preset	DDDD	0 ~ 9999	
W	C	DDDD	0 ~ 9999	
W	C_Curr	DDDD	0 ~ 9999	Counter_Current
W	C_Preset	DDDD	0 ~ 9999	

Precaution:

If you use the Relay(bit) register. Please place zero behind address.

For example, if you want to read Relay(bit)100, you just set the address as "1000".

Wiring Diagram:

HMI COM1 RS232 9P D-Sub Male	HMI COM2 RS232 9P D-Sub Male	HMI COM3 RS232 9P D-Sub Female	KENEYCE OP-26486 RS232
2 RX	6 RX	8 RX	3 TXD
3 TX	4 TX	7 TX	2 RXD
5 GND	5 GND	5 GND	5 GND

Driver Version:

Version	Date	Description
V2.20	Jul/28/2009	

Korenix 6550

Supported series: <http://www.korenix.com/>

HMI Setting:

Parameters	Recommend	Option	Notes
PLC type	Korenix 6550		Modbus protocol
PLC I/F	Ethernet		
PLC st. no.		0	
Port no.	502		

Device Address:

Bit/Word	Device type	Format	Range	Memo
B	0X	DDDDD	1 ~ 65535	
B	1X	DDDDD	1 ~ 65535	
B	3x_Bit	DDDDDdd	1 ~ 6553515	
B	4x_Bit	DDDDDdd	1 ~ 6553515	
B	6x_Bit	DDDDDdd	1 ~ 6553515	
W	3X	DDDDD	1 ~ 65535	
W	4X	DDDDD	1 ~ 65535	
W	5X	DDDDD	1 ~ 65535	
W	6X	DDDDD	1 ~ 65535	

Wiring Diagram:

Direct connect (crossover cable):

HMI RJ45 Female	Wire Color	PLC RJ45 Female
1 TX+	White/Orange	3 RX+
2 TX-	Orange	6 RX-
3 RX+	White/Green	1 TX+
4 BD4+	Blue	4 BD4+
5 BD4-	White/Blue	5 BD4-
6 RX-	Green	2 TX-
7 BD3+	White/Brown	7 BD3+
8 BD3-	Brown	8 BD3-



Through a hub:

HMI RJ45 Female	Wire Color	PLC RJ45 Female
1 TX+	White/Orange	1 TX+
2 TX-	Orange	2 TX-
3 RX+	White/Green	3 RX+
4 BD4+	Blue	4 BD4+
5 BD4-	White/Blue	5 BD4-
6 RX-	Green	6 RX-
7 BD3+	White/Brown	7 BD3+
8 BD3-	Brown	8 BD3-



Driver Version:

Version	Date	Description
V1.61	Apr/17/2009	

Koyo CLICK

Supported series: KOYO CLICK PLC series.

Website: <http://www.automationdirect.com>

HMI Setting:

Parameters	Recommend	Option	Notes
PLC type	Koyo CLICK		
PLC I/F	RS232		
Baud rate	38400	Communications Port1 (fixed)	Reference PLC Specification
Parity	Odd	Communications Port1 (fixed)	Reference PLC Specification
Data bits	8	Communications Port1 (fixed)	Reference PLC Specification
Stop bits	1	Communications Port1 (fixed)	Reference PLC Specification
PLC st. no.	1	Communications Port1 (fixed)	Reference PLC Specification

Device Address:

Bit/Word	Device type	Format	Range	Memo
B	X	Ddd	001 ~ 816	Input Status (Read Only)
B	Y	Ddd	001 ~ 816	Output Status
B	C	DDDD	1 ~ 2000	Control Bit
B	T	DDD	1 ~ 500	Timer Status (Read Only)
B	CT	DDD	1 ~ 250	Counter Status (Read Only)
B	SC	DDDD	1 ~ 1000	System Control Bit (Read Only)
W	DS	DDDD	1 ~ 4500	Data Registers
W	DD	DDDD	1 ~ 1000	Data Registers (Double word)
W	DH	DDD	1 ~ 500	Data Registers
W	DF	DDD	1 ~ 500	Data Registers (Double word)
W	XD	D	0 ~ 8	Input Status Registers (Read Only)
W	YD	D	0 ~ 8	Output Status Registers
W	TD	DDD	1 ~ 500	Timer Current Values (Read Only)

W	CTD	DDD	1 ~ 250	Counter Current Values (Double word/Read Only)
W	SD	DDDD	1 ~ 1000	System Data Registers (Read Only)
W	TXT	DDDD	1 ~ 1000	Text Data Registers

ddd: Decimal / hhh:Hexadecimal / ooo:Octal

Wiring Diagram:

KOYO CLICK PLC Com Port:

6 pin RJ12 Phone Type Jack – both ports

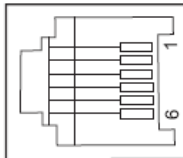



Port 1 Pin Descriptions		
1	0V	Power (-) connection (GND)
2	5V	Power (+) connection
3	RXD	Receive data (RS-232)
4	TXD	Transmit data (RS-232)
5	NC	No connection
6	0V	Power (-) connection (GND)

Port 2 Pin Descriptions		
1	0V	Power (-) connection (GND)
2	5V	Power (+) connection
3	RXD	Receive data (RS-232)
4	TXD	Transmit data (RS-232)
5	RTS	Request to send
6	0V	Power (-) connection (GND)

9P D-Sub to 6P RJ12 Jack:

HMI COM1 RS232 9P D-Sub Male	HMI COM2 RS232 9P D-Sub Male	HMI COM3 RS232 9P D-Sub Female	KOYO CLICK PLC RS232 6P RJ12 Jack
2 RX	6 RX	8 RX	4 TXD
3 TX	4 TX	7 TX	3 RXD
5 GND	5 GND	5 GND	1 GND

Driver Version:

Version	Date	Description
V1.50	Jun/22/2010	

KOYO DIRECT

Supported series: KOYO DirectLogic series PLC DL05, DL06, DL105, DL205, DL305, and DL405 series.

Website: <http://www.automationdirect.com>

HMI Setting:

Parameters	Recommend	Option	Notes
PLC type	KOYO DIRECT		
PLC I/F	RS232	RS232, RS485	
Baud rate	9600	9600, 19200, 38400	
Parity	Odd	Even, Odd, None	
Data bits	8	7, 8	
Stop bits	1	1	
PLC st. no.	1	1-90	

PLC Setting:

	<ol style="list-style-type: none"> 1. The PLC must not have a password. 2. PLC must be set for Full Duplex operation. 3. PLC must be set for No Hardware Handshaking. 4. The PLC must be set to use the 'K' Sequence Protocol. 5. Set the mode switch to the TERM mode 6. When using the D4-440 CPU, you must set the station number to 1.
--	--

Device Address:

Bit/Word	Device type	Format	Range	Memo
B	X	O000	0 ~ 4000	Input Bits
B	Y	O000	0 ~ 4000	Output Bits
B	C	O0000	0 ~ 10000	Control Relays
B	T	O000	0 ~ 1000	Timer Status Bits
B	CT	O000	0 ~ 1000	Counter Status Bits
B	S	O000	0 ~ 2000	

B	SP	O000	0 ~ 2000	
B	GX	O0000	0 ~ 10000	
B	GY	O0000	0 ~ 10000	
W	Timer	O000	0 ~ 1000	
W	Counter	O000	0 ~ 1000	
W	V	O0000	0 ~ 77777	V Memory

Wiring Diagram:

9P D-Sub to 6P RJ12 Jack: CPU unit:

DL05/DL06/DL105/DL230/DL240/DL250/DL350/DL450 RS232 port

HMI COM1 RS232 9P D-Sub Male	HMI COM2 RS232 9P D-Sub Male	HMI COM3 RS232 9P D-Sub Female	KOYO CLICK PLC RS232 6P RJ12 Jack	
2 RX	6 RX	8 RX	4 TX	
3 TX	4 TX	7 TX	3 RX	
5 GND	5 GND	5 GND	1 GND	
				

9P D-Sub to 15P D-Sub: CPU unit: DL06/DL250 CPU Port2 RS232

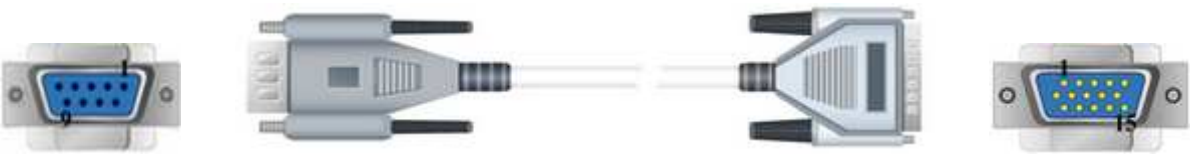
HMI COM1 RS232 9P D-Sub Female	HMI COM2 RS232 9P D-Sub Female	HMI COM3 RS232 9P D-Sub Male	KOYO DirectLogic PLC CPU RS232 Port2 15P D-Sub	
2 RX	6 RX	8 RX	2 TX	
3 TX	4 TX	7 TX	3 RX	
5 GND	5 GND	5 GND	7 GND	
			4 RTC	circuit
			5 CTS	
				

9P D-Sub to 15P D-Sub: CPU unit: DL06/DL250 CPU Port2 RS422

HMI COM1 RS485 4W 9P D-Sub Female			KOYO DirectLogic PLC CPU RS422 Port2 15P D-Sub	
1 RX-			10 TX-	
2 RX+			9 TX+	
3 TX-			6 RX-	
4 TX+			13 RX+	
5 GND			7 GND	
			11 RTS+	Circuit
			14 CTS+	
			12 RTS-	Circuit
			15 CTS-	

Note: DL06/DL250 CPU Port2 include RS232 and RS422

9P D-Sub to 15P D-Sub: CPU unit: DL430/DL440/DL450 CPU unit Port0 RS232

HMI COM1 RS232 9P D-Sub Female	HMI COM2 RS232 9P D-Sub Female	HMI COM3 RS232 9P D-Sub Male	KOYO DirectLogic PLC DL405 CPU RS232 Port0 15P D-Sub	
2 RX	6 RX	8 RX	2 TX	
3 TX	4 TX	7 TX	3 RX	
5 GND	5 GND	5 GND	13 GND	
			1 YOP	circuit
			7 CTS	
			2 YOM	circuit
			4 ONLINE	
			14 GND	

9P D-Sub to 25P D-Sub: CPU unit: DL430/DL440/DL450 CPU unit Port1 & DL350 CPU unit Port2 RS232

HMI COM1 RS232 9P D-Sub Male	HMI COM2 RS232 9P D-Sub Mmale	HMI COM3 RS232 9P D-Sub Male	KOYO DirectLogic PLC DL305/405 CPU RS232 Port 25P D-Sub	
2 RX	6 RX	8 RX	2 TX	
3 TX	4 TX	7 TX	3 RX	
5 GND	5 GND	5 GND	7 GND	
			4 RTC	Circuit
			5 CTS	

9P D-Sub to 25P D-Sub: CPU unit: DL430/DL440/DL450 CPU unit Port1 & DL350 CPU unit Port2 RS422

HMI COM1 RS485 4W 9P D-Sub Male			KOYO DirectLogic PLC DL305/405 CPU RS422 Port 25P D-Sub	
1 RX-			16 TX-	
2 RX+			14 TX+	
3 TX-			10 RX-	
4 TX+			9 RX+	
5 GND			7 GND	
			19 RTS+	circuit
			11 CTS+	
			18 RTS-	circuit
			23 CTS-	

9P D-Sub to 25P D-Sub: CPU unit: DL450 CPU unit Port3 RS422

HMI COM1 RS485 4W 9P D-Sub Male			KOYO DirectLogic PLC DL405 CPU RS422 Port3 25P D-Sub
1 RX-			13 TX-
2 RX+			12 TX+
3 TX-			25 RX-
4 TX+			24 RX+
5 GND			7 GND
			

9P D-Sub to 25P D-Sub: Communication unit: DL205 series D2-DCM and DL405 series D4-DCM RS232

HMI COM1 RS232 9P D-Sub Male	HMI COM2 RS232 9P D-Sub Male	HMI COM3 RS232 9P D-Sub Female	KOYO DirectLogic PLC DL205/405 DCM RS232 Port 25P D-Sub
2 RX	6 RX	8 RX	2 TX
3 TX	4 TX	7 TX	3 RX
5 GND	5 GND	5 GND	7 GND
			4 RTC
			5 CTS
			

Driver Version:

Version	Date	Description
V1.30	Nov/02/2010	

Koyo Ethernet

Supported series: KOYO DirectLogic series, model H0-ECOM100, H2-ECOM100.

Website: <http://www.automationdirect.com>

HMI Setting:

Parameters	Recommend	Option	Notes
PLC type	Koyo Ethernet		
PLC I/F	Ethernet		UDP/IP
PLC st. no.	No need to set station no.	0	
Port no.	28784		

Device Address:

Bit/Word	Device type	Format	Range	Memo
B	GX	OOOO	0 ~ 3777	Global I/O
B	X	OOOO	0 ~ 1777	Real Word Inputs
B	SP	OOOO	0 ~ 1777	Special Purpose Relays
B	GY	OOOO	0 ~ 3777	More Global I/O
B	Y	OOOO	0 ~ 1777	Real Word Outputs
B	C	OOOO	0 ~ 3777	Control Relays
B	S	OOOO	0 ~ 1777	Stage Status Bits
B	T	OOO	0 ~ 377	Timer Status Bits
B	CT	OOO	0 ~ 377	Counter Status Bits
W	V	OOOOO	0 ~ 41237	V-memory
W	CMM_32	HHH	1 ~ 200	GX, X, SP
W	CCM_33	HHH	1 ~ 340	GY, Y, C, S, Y, CT, V
W	CCM_31	HHHH	1 ~ 42a0	V

EasyBuilder device addresses range may different with PLC extended mode, please refer EasyBuilder's addresses range as above.

ddd:Decimal, hhh:Hexadecimal, ooo:Octal

Wiring Diagram:

Direct connect (crossover cable):

HMI RJ45 Female	Wire Color	PLC RJ45 Female
1 TX+	White/Orange	3 RX+
2 TX-	Orange	6 RX-
3 RX+	White/Green	1 TX+
4 BD4+	Blue	4 BD4+
5 BD4-	White/Blue	5 BD4-
6 RX-	Green	2 TX-
7 BD3+	White/Brown	7 BD3+
8 BD3-	Brown	8 BD3-



Through a hub:

HMI RJ45 Female	Wire Color	PLC RJ45 Female
1 TX+	White/Orange	1 TX+
2 TX-	Orange	2 TX-
3 RX+	White/Green	3 RX+
4 BD4+	Blue	4 BD4+
5 BD4-	White/Blue	5 BD4-
6 RX-	Green	6 RX-
7 BD3+	White/Brown	7 BD3+
8 BD3-	Brown	8 BD3-



Driver Version:

Version	Date	Description
V1.10	Jul/03/2009	

Lenze

Supported series: PLC Model No. : 9300/8200 series

Pass-through 2102IB fieldbus module: RS485 (LECOM B)

Website: <http://www.lenze.de>

HMI Setting:

Parameters	Recommend	Option	Notes
PLC type	Lenze		
PLC I/F	RS232		
Baud rate	9600	9600, 19200	
Parity	None	Even, Odd, None	
Data bits	7	7,8	
Stop bits	1	1, 2	
PLC st. no.	1	0-255	

PLC Setting:

Communication mode	Same as the MT500 setting
--------------------	---------------------------

Device Address:

Bit/Word	Device type	Format	Range	Memo
B	CNB	DDDDdd	0 ~ 999915	
W	CI	DDDDdd	0 ~ 819200	
W	CD	DDDDdd	0 ~ 819200	
W	CF	DDDDdd	0 ~ 819200	
W	CNI	DDDD	0 ~ 9999	integer
W	CND	DDDD	0 ~ 9999	DWord
W	CNF	DDDD	0 ~ 9999	DWord(float point)

Wiring Diagram:

HMI COM1 RS485 2W 9P D-Sub Female	HMI COM3 RS485 2W 9P D-Sub Female		Lenze 2102IB LECOM-B RS485 plug-in terminal 4-pole
1 RX-	6 Data-		72 T/R (A)
2 RX+	9 Data+		71 T/R (B)
5 GND	5 GND		

Driver Version:

Version	Date	Description
V1.10	Apr/17/2009	

LIYAN EX series

Supported series : LIYAN PLC Ex/Ex1s/Ex1n/Ex2n series

Website: <http://www.liyanplc.com/>

HMI Setting:

Parameters	Recommend	Option	Notes
PLC type	Mitsubishi FX0n/FX2		
PLC I/F	RS232	RS232	
Baud rate	9600	9600~115200	
Parity	Even	Even, Odd, None	
Data bits	7	7,8	
Stop bits	1	1,2	
PLC st. no.	0	0-255	Must match the PLC's port setting.

Device Address:

Bit/Word	Device type	Format	Range	Memo
B	X	ooo	0-377	Input relay
B	Y	ooo	0-377	Output relay
B	M	ddd	0-9999	Internal bit memory
B	T	ddd	0-255	Timer bit memory
B	C	ddd	0-255	Counter bit memory
W	TV	ddd	0-255	Timer register
W	CV	ddd	0~199	Counter Register
W	D	ddd	0-9999	data Register
W	CV2	ddd	200-255	Counter Register(Double word)
W	SD	ddd	8000-9999	Special data register

Wiring Diagram:

9P D-Sub to 8P Mini-DIN: Ex, Ex1s, Ex1n, Ex2n series

HMI COM1 RS232 9P D-Sub Male	HMI COM2 RS232 9P D-Sub Male	HMI COM3 RS232 9P D-Sub Female	LIYAN Ex series CPU Port RS232 8P Mini-DIN
2 RX	6 RX	8 RX	7 TXD
3 TX	4 TX	7 TX	4 RXD
5 GND	5 GND	5 GND	8 GND



Driver Version:

Version	Date	Description
V1.10	Aug/12/2009	

LS GLOFA Cnet

Supported series: LS GLOFA GM6/GM7 CPU port. G7L-CUEB / G6L-CUEB / G4L-CUEA / G3L-CUEA Cnet module

Website: <http://www.lgis.com/>

HMI Setting:

Parameters	Recommend	Option	Notes
PLC type	LS GLOFA Cnet		
PLC I/F	RS232	RS232/RS485 2W/4W	
Baud rate	9600	9600~115200	
Parity	None	Even, Odd, None	
Data bits	8	7, 8	
Stop bits	1	1	
PLC st. no.	0	0~31	

PLC Setting:

Communication mode	9600,N,8,1 (default), Cnet protocol
Communication module	Applicable mode: 1 Dedicated communication

Device Address:

Bit/Word	Device type	Format	Range	Memo
B	IX	ddDdd	0 ~ 63763	Input
B	QX	ddDdd	0 ~ 63763	Output
B	MX	DDDDD	0 ~ 32767	Internal relay
W	MW	DDDDD	0 ~ 32767	Data register
DW	MD	DDDDD	0 ~ 16383	Double word

Wiring Diagram:

9P D-Sub to 9P D-Sub:

HMI COM1 RS232 9P D-Sub Male	HMI COM2 RS232 9P D-Sub Male	HMI COM3 RS232 9P D-Sub Female	LS GLOFA GM CPU Port RS232 9P D-Sub
2 RX	6 RX	8 RX	7 TXD
3 TX	4 TX	7 TX	4 RXD
5 GND	5 GND	5 GND	5 GND



9P D-Sub to 9P D-Sub: Communication Module (G7L-CUEB / G6L-CUEB / G4L-CUEA / G3L-CUEA Cnet RS232)

HMI COM1 RS232 9P D-Sub Male	HMI COM2 RS232 9P D-Sub Male	HMI COM3 RS232 9P D-Sub Female	LS GLOFA GM RS232 9P D-Sub
2 RX	6 RX	8 RX	3 TXD
3 TX	4 TX	7 TX	2 RXD
5 GND	5 GND	5 GND	5 GND
			1 CD
			7 RTS
			8 CTS
			4 DTR
			6 DSR

circuit

circuit



Communication Module (G7L-CUEC / G6L-CUEC / G4L-CUEA / G3L-CUEA Cnet RS422)

HMI COM1 RS485 4W 9P D-Sub Female			RS422
1 RX-			SDA
2 RX+			SDB
3 TX-			RDA

4 TX+			RDB
5 GND			GND

Driver Version:

Version	Date	Description
V1.80	Jun/08/2010	

LS GLOFA GM3467 (LOADER)

Supported series: LS GLOFA series GM3, GM4, GM6, GM7 CPU port.

Website: <http://www.lgis.com/>

HMI Setting:

Parameters	Recommend	Option	Notes
PLC type	LS GLOFA GM3467 (LOADER)		
PLC I/F	RS232		
Baud rate	38400		
Data bits	8		
Parity	None		
Stop bits	1		
PLC st. no.	1		

Device Address:

Bit/Word	Device type	Format	Range	Memo
B	MX	DDDDDD	0 ~ 524272	
B	IX	ddDdd	0 ~ 63763	00.0.0 ~63.7.63 (dd.D.dd)
B	QX	ddDdd	0 ~ 63763	00.0.0 ~63.7.63 (dd.D.dd)
W	MW	DDDDD	0 ~ 32767	
W	MD	DDDDD	0 ~ 16383	
W	IW	HHH	0 ~ 273	
W	QW	HHH	0 ~ 273	

Wiring Diagram:

9P D-Sub to 9P D-Sub:

HMI COM1 RS232 9P D-Sub Male	HMI COM2 RS232 9P D-Sub Male	HMI COM3 RS232 9P D-Sub Female	LS GLOFA series RS232 9P D-Sub
2 RX	6 RX	8 RX	3 TD
3 TX	4 TX	7 TX	2 RD
5 GND	5 GND	5 GND	5 GND



Driver Version:

Version	Date	Description
V1.30	Mar/08/2010	

LS MASTER-K Cnet

Supported series: LS MASTER-K series: K80S, K200S, K300S, and K1000S

Website: <http://www.lgis.com/>

HMI Setting:

Parameters	Recommend	Option	Notes
PLC type	LS MASTER-K Cnet		
PLC I/F	RS232	RS232/RS485	
Baud rate	38400	9600, 19200, 38400	
Parity	None	Even, Odd, None	
Data bits	8	8	
Stop bits	1	1	
PLC st. no.	0	0-31	Must match the PLC's port setting.

Online Simulator	YES	
------------------	-----	--

Device Address:

Bit/Word	Device type	Format	Range	Memo
B	P	DDDh	0 ~ 255f	I/O Relay (P)
B	K	DDDh	0 ~ 255f	Keep Relay (K)
B	M	DDDh	0 ~ 255f	Auxiliary Relay (M)
B	L	DDDh	0 ~ 255f	Link Relay (L)
B	F	DDDh	0 ~ 255f	Special Relay (F)
W	TV	DDD	0 ~ 255	Timer Present Value
W	CV	DDD	0 ~ 255	Counter Present Value
W	D	DDDD	0 ~ 9999	Data Register (D)

Wiring Diagram:

9P D-Sub to 9P D-Sub:

HMI COM1 RS232 9P D-Sub Male	HMI COM2 RS232 9P D-Sub Male	HMI COM3 RS232 9P D-Sub Female	CPU Port Cnet I/F RS232 9P D-Sub
2 RX	6 RX	8 RX	7 TX
3 TX	4 TX	7 TX	4 RX
5 GND	5 GND	5 GND	5 GND



If connecting with Cnet module, please refer Cnet module's document.

Driver Version:

Version	Date	Description
V1.00	Apr/19/2010	Driver released.

LS MASTER-K10S1

Supported series: LS MASTER-K10S1

Website: <http://www.lgis.com/>

HMI Setting:

Parameters	Recommend	Option	Notes
PLC type	LS MASTER-K10S1		
PLC I/F	RS232	RS232/RS485	
Baud rate	9600		
Parity	None	None	
Data bits	8	8	
Stop bits	1	1	
PLC st. no.	0		Must match the PLC's port setting.

Device Address:

Bit/Word	Device type	Format	Range	Memo
B	P	DDDh	0 ~ 255f	I/O Relay (P)
B	K	DDDh	0 ~ 255f	Keep Relay (K)
B	M	DDDh	0 ~ 255f	Auxiliary Relay (M)
B	L	DDDh	0 ~ 255f	Link Relay (L)
B	F	DDDh	0 ~ 255f	Special Relay (F)
B	T	DDD	0 ~ 255	Timer (T)
B	C	DDD	0 ~ 255	Counter (C)
W	TV	DDD	0 ~ 255	Timer Present Value
W	CV	DDD	0 ~ 255	Counter Present Value
W	D	DDDD	0 ~ 9999	Data Register (D)

Wiring Diagram:

9P D-Sub to 9P D-Sub:

HMI COM1 RS232 9P D-Sub Male	HMI COM2 RS232 9P D-Sub Male	HMI COM3 RS232 9P D-Sub Female	CPU Port RS232 9P D-Sub
2 RX	6 RX	8 RX	3 TX
3 TX	4 TX	7 TX	2 RX
5 GND	5 GND	5 GND	5 GND



Driver Version:

Version	Date	Description
V1.00	Sep/08/2009	Driver released.

LS MASTER-K300S CPU

Supported series: LS MASTER-K series: K80S, K120S, K200S, K300S, K1000S

Website: <http://www.lgis.com/>

HMI Setting:

Parameters	Recommend	Option	Notes
PLC type	LG MASTER-K300S CPU		
PLC I/F	RS232	RS232/RS485	
Baud rate	38400	9600, 19200, 38400	
Parity	None	Even, Odd, None	
Data bits	8	8	
Stop bits	1	1	
PLC st. no.	0	0-31	Must match the PLC's port setting.

Online Simulator	YES	
------------------	-----	--

Device Address:

Bit/Word	Device type	Format	Range	Memo
B	P	DDDh	0 ~ 255f	I/O Relay (P)
B	K	DDDh	0 ~ 255f	Keep Relay (K)
B	M	DDDh	0 ~ 255f	Auxiliary Relay (M)
B	L	DDDh	0 ~ 255f	Link Relay (L)
B	F	DDDh	0 ~ 255f	Special Relay (F)
W	TV	DDD	0 ~ 255	Timer Present Value
W	CV	DDD	0 ~ 255	Counter Present Value
W	D	DDDD	0 ~ 9999	Data Register (D)

Wiring Diagram:

9P D-Sub to 9P D-Sub:

HMI COM1 RS232 9P D-Sub Male	HMI COM2 RS232 9P D-Sub Male	HMI COM3 RS232 9P D-Sub Female	CPU Port RS232 9P D-Sub
2 RX	6 RX	8 RX	3 TX
3 TX	4 TX	7 TX	2 RX
5 GND	5 GND	5 GND	5 GND



Driver Version:

Version	Date	Description
V1.10	Dec/30/2008	

LS XGB/XGT

Supported series : LS XGB/XGT Series

Website: <http://www.lgis.com/>

HMI Setting:

Parameters	Recommend	Option	Notes
PLC type	LS XGB/XGT		
PLC I/F	RS232	RS232/RS485	
Baud rate	115200	9600~115200	
Parity	None	Even, Odd, None	
Data bits	8	7, 8	
Stop bits	1	1	
PLC st. no.	1	0-31	Must match the PLC's port setting.

Device Address:

Bit/Word	Device type	Format	Range	Memo
B	P	DDDDh	0 ~ 2047f	I/O device_2,048 points
B	M	DDDDh	0 ~ 2047f	Internal device_4,096 points
B	L	DDDDDh	0 ~ 11263f	Communication device_20,480 points
B	K	DDDDh	0 ~ 2559f	Preservation device_4,096 points
B	F	DDDDh	0 ~ 2047f	Special device_4,096 point
B	T	DDDD	0 ~ 2047	Timer device_256 point
B	C	DDDD	0 ~ 2047	Counter device_256 point
B	S	DDDDD	0 ~ 12799	Relay for step control
B	D_Bit	DDDDDh	0 ~ 32767f	Data register_Bit expression (D0000.0)
B	U_Bit	DH.DDh	0.000 ~ 7f.31f	XGK-CPUE:hh(0~1f)
W	D	DDDDD	0 ~ 32767	Data register_5120 words
W	U	DH.DD	0.00 ~ 7f.31	Analog data register_256 words

W	N	DDDDD	0 ~ 21503	Communication data register_3,936 words
W	Z	DDD	0 ~ 127	Index register_128 words
W	T	DDDD	0 ~ 2047	Timer current value register_256 words
W	C	DDDD	0 ~ 2047	Counter current value register_256 words

Wiring Diagram:

9P D-Sub to 6P Mini-DIN:

HMI COM1 RS232 9P D-Sub Male	HMI COM2 RS232 9P D-Sub Male	HMI COM3 RS232 9P D-Sub Female	XGB main unit RS232 6P Mini-DIN
2 RX	6 RX	8 RX	6 TXD
3 TX	4 TX	7 TX	2 RXD
5 GND	5 GND	5 GND	3 GND



Driver Version:

Version	Date	Description
V1.30	Apr/17/2009	

LS XGB/XGT FEnet (Ethernet)

Supported series: LS XGB/XGT with XBL-EMTA

Website: <http://www.lgis.com/>

HMI Setting:

Parameters	Recommend	Option	Notes
PLC type	LS XGB/XGT FEnet (Ethernet)		
PLC I/F	Ethernet		
PLC st. no.	0	0~255	
Port no.	2004		

PLC Setting:

Communication mode	FEnet Potocol
--------------------	---------------

Device Address:

Bit/Word	Device type	Format	Range	Memo
B	P	DDDDh	0 ~ 2047f	I/O device_2,048 points
B	M	DDDDh	0 ~ 2047f	Internal device_4,096 points
B	L	DDDDDh	0 ~ 11263f	Communication device_20,480 points
B	K	DDDDh	0 ~ 2559f	Preservation device_4,096 points
B	F	DDDDh	0 ~ 2047f	Special device_4,096 point
B	T	DDDD	0 ~ 2047	Timer device_256 point
B	C	DDDD	0 ~ 2047	Counter device_256 point
B	S	DDDDD	0 ~ 12799	Relay for step control
B	D_Bit	DDDDDh	0 ~ 32767f	Data register_Bit expression (D0000.0)
B	U_Bit	DH.DDh	0.000 ~ 7f.31f	XGK-CPUE:hh(0~1f)
W	D	DDDDD	0 ~ 32767	Data register_5120 words
W	U	DH.DD	0.00 ~ 7f.31	Analog data register_256 words

W	N	DDDDD	0 ~ 21503	Communication data register_3,936 words
W	Z	DDD	0 ~ 127	Index register_128 words
W	T	DDDD	0 ~ 2047	Timer current value register_256 words
W	C	DDDD	0 ~ 2047	Counter current value register_256 words

Wiring Diagram:

Direct connect (crossover cable):

HMI RJ45 Female	Wire Color	PLC RJ45 Female
1 TX+	White/Orange	3 RX+
2 TX-	Orange	6 RX-
3 RX+	White/Green	1 TX+
4 BD4+	Blue	4 BD4+
5 BD4-	White/Blue	5 BD4-
6 RX-	Green	2 TX-
7 BD3+	White/Brown	7 BD3+
8 BD3-	Brown	8 BD3-



Through a hub:

HMI RJ45 Female	Wire Color	PLC RJ45 Female
1 TX+	White/Orange	1 TX+
2 TX-	Orange	2 TX-
3 RX+	White/Green	3 RX+
4 BD4+	Blue	4 BD4+
5 BD4-	White/Blue	5 BD4-
6 RX-	Green	6 RX-
7 BD3+	White/Brown	7 BD3+
8 BD3-	Brown	8 BD3-



Driver Version:

Version	Date	Description
V1.20	Apr/17/2009	

LS XGL-CH2A Cnet

Supported series: LS XGT series communication module XGL-CH2A

Website: <http://www.lgis.com/>

HMI Setting:

Parameters	Recommend	Option	Notes
PLC type	LS XGL-CH2A Cnet		
PLC I/F	RS232	RS232/RS485 2W/4W	
Baud rate	115200	9600~115200	
Parity	None	Even, Odd, None	
Data bits	8	7, 8	
Stop bits	1	1	
PLC st. no.	0	1	

Device Address:

Bit/Word	Device type	Format	Range	Memo
B	P	DDDDh	0 ~ 2047f	I/O device
B	M	DDDDh	0 ~ 2047f	Internal device
B	L	DDDDDh	0 ~ 11263f	Communication device
B	K	DDDDh	0 ~ 2047f	Preservation device
B	F	DDDDh	0 ~ 2047f	Special device(write available from 1025)
B	T	DDDD	0 ~ 2047	Timer device
B	C	DDDD	0 ~ 2047	Counter device
B	S	DDDDD	0 ~ 12799	Relay for step control
B	D_Bit	DDDDDh	0 ~ 32767f	Data register_Bit expression (D0000.0)
B	U_Bit	DH.DDH	0.000 ~ 3f.31f	XGK-CPUE : hh(0~1f)
W	D	DDDDD	0 ~ 32767	Data register
W	U	DH.DD	0.00 ~ 3f.31	Analog data register XGK-CPUE : hh(0~1f)
W	N	DDDDD	0 ~ 21503	Communication data register

Bit/Word	Device type	Format	Range	Memo
W	Z	DDD	0 ~ 127	Index register_128 words
W	T	DDDD	0 ~ 2047	Timer current value register
W	C	DDDD	0 ~ 2047	Counter current value register
W	R	DDDDD	0 ~ 32767	
W	ZR	DDDDD	0 ~ 32767	

Wiring Diagram:

9P D-Sub to 9P D-Sub:

HMI COM1 RS232 9P D-Sub Male	HMI COM2 RS232 9P D-Sub Male	HMI COM3 RS232 9P D-Sub Female	XGL-CH2A CH1 RS232 9P D-Sub
2 RX	6 RX	8 RX	3 TXD
3 TX	4 TX	7 TX	2 RXD
5 GND	5 GND	5 GND	5 GND



9P D-Sub to Terminals:

HMI COM1 RS485 4W 9P D-Sub Female			XGL-CH2A CH2 5P Terminals
1 RX-			TXD-
2 RX+			TXD+
3 TX-			RXD-
4 TX+			RXD+
5 GND			GND

Driver Version:

Version	Date	Description
V1.20	Nov/30/2009	

LS XGL-EFMT FEnet (Ethernet)

Supported series: LS XGT series XGL-EFMT Ethernet module.

Website: <http://www.lgis.com/>

HMI Setting:

Parameters	Recommend	Option	Notes
PLC type	LS XGL-EFMT FEnet (Ethernet)		
PLC I/F	Ethernet		
Port No.	2004		
PLC st. no.	0		

Device Address:

Bit/Word	Device type	Format	Range	Memo
B	P	DDDDh	0 ~ 2047f	I/O device
B	M	DDDDh	0 ~ 2047f	Internal device
B	L	DDDDDh	0 ~ 11263f	Communication device
B	K	DDDDh	0 ~ 2047f	Preservation device
B	F	DDDDh	0 ~ 2047f	Special device(write available from 1025)
B	T	DDDD	0 ~ 2047	Timer device
B	C	DDDD	0 ~ 2047	Counter device
B	S	DDDDD	0 ~ 12799	Relay for step control
B	D_Bit	DDDDDh	0 ~ 32767f	Data register_Bit expression (D0000.0)
B	U_Bit	DH.DDH	0.000 ~ 3f.31f	XGK-CPUE : hh(0~1f)
W	D	DDDDD	0 ~ 32767	Data register
W	U	DH.DD	0.00 ~ 3f.31	Analog data register XGK-CPUE : hh(0~1f)
W	N	DDDDD	0 ~ 21503	Communication data register
W	Z	DDD	0 ~ 127	Index register_128 words
W	T	DDDD	0 ~ 2047	Timer current value register
W	C	DDDD	0 ~ 2047	Counter current value register
W	R	DDDDD	0 ~ 32767	

Bit/Word	Device type	Format	Range	Memo
W	ZR	DDDDD	0 ~ 32767	

Wiring Diagram:

Direct connect (crossover cable):

HMI RJ45 Female	Wire Color	PLC RJ45 Female
1 TX+	White/Orange	3 RX+
2 TX-	Orange	6 RX-
3 RX+	White/Green	1 TX+
4 BD4+	Blue	4 BD4+
5 BD4-	White/Blue	5 BD4-
6 RX-	Green	2 TX-
7 BD3+	White/Brown	7 BD3+
8 BD3-	Brown	8 BD3-



Through a hub:

HMI RJ45 Female	Wire Color	PLC RJ45 Female
1 TX+	White/Orange	1 TX+
2 TX-	Orange	2 TX-
3 RX+	White/Green	3 RX+
4 BD4+	Blue	4 BD4+
5 BD4-	White/Blue	5 BD4-
6 RX-	Green	6 RX-
7 BD3+	White/Brown	7 BD3+
8 BD3-	Brown	8 BD3-



Driver Version:

Version	Date	Description
V1.20	Nov/30/2009	

LS XGT/XGK CPU DIRECT

Supported series: LS XGT/XGK CPU RS232 port.

Website: <http://www.lgis.com/>

HMI Setting:

Parameters	Recommend	Option	Notes
PLC type	LS XGT/XGK CPU DIRECT		
PLC I/F	RS232	RS232/RS485	
Baud rate	115200	9600~115200	
Parity	None	Even, Odd, None	
Data bits	8	7, 8	
Stop bits	1	1	
PLC st. no.	0		

Device Address:

Bit/Word	Device type	Format	Range	Memo
B	P	DDDDh	0 ~ 2047f	I/O device
B	M	DDDDh	0 ~ 2047f	Internal device
B	L	DDDDDh	0 ~ 11263f	Communication device
B	K	DDDDh	0 ~ 2047f	Preservation device
B	F	DDDDh	0 ~ 2047f	Special device(write available from 1025)
B	T	DDDD	0 ~ 2047	Timer device
B	C	DDDD	0 ~ 2047	Counter device
B	S	DDDDD	0 ~ 12799	Relay for step control
B	D_Bit	DDDDDh	0 ~ 32767f	Data register_Bit expression (D0000.0)
B	U_Bit	DH.DDh	0.000 ~ 3f.31f	XGK-CPUE : hh(0~1f)
W	D	DDDDD	0 ~ 32767	Data register
W	U	DH.DD	0.00 ~ 3f.31	Analog data register XGK-CPUE : hh(0~1f)
W	N	DDDDD	0 ~ 21503	Communication data register
W	Z	DDD	0 ~ 127	Index register_128 words

W	T	DDDD	0 ~ 2047	Timer current value register
W	C	DDDD	0 ~ 2047	Counter current value register
W	R	DDDDD	0 ~ 32767	
W	ZR	DDDDD	0 ~ 32767	
W	TS	DDDD	0 ~ 2047	Setup value
W	CS	DDDD	0 ~ 2047	Setup value

Wiring Diagram:

9P D-Sub to 9P D-Sub:

HMI COM1 RS232 9P D-Sub Male	HMI COM2 RS232 9P D-Sub Male	HMI COM3 RS232 9P D-Sub Female	XGT main unit RS232 9P D-Sub
2 RX	6 RX	8 RX	3 TXD
3 TX	4 TX	7 TX	2 RXD
5 GND	5 GND	5 GND	5 GND



Driver Version:

Version	Date	Description
V1.20	Nov/30/2009	

Master (Master-Slave Protocol)

To connect HMI with MT500, MT500 has to set as [Slave].

HMI Setting:

Parameters	Recommend	Option	Notes
PLC type	Master (Master-Slave Protocol)		
PLC I/F	RS232		
Baud rate	115200	38400, 115200	
Parity	Even		
Data bits	8		
Stop bits	1		
HMI st. no.	0		
PLC st. no.	0		
Parameter 1	MT500 PLC ID	Use PLCAddressView.exe to find PLC ID.	

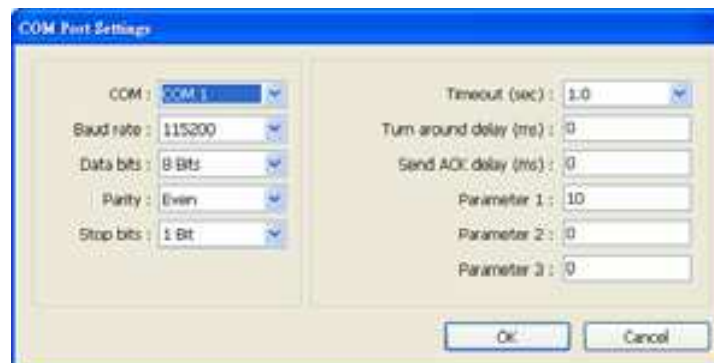

PLC Setting:

Communication mode	MT500 Multiple HMI set Slave.
--------------------	-------------------------------

System Parameter Setting

PLC: **General** | Indicator | Security | Editor | Hardware | Atmc

PLC type: **MITSUBISHI FX0n/FX2**

HMI model: **MT510T/MT508T (640 x 480)**

PLC I/F port: **RS-485 4W** Baud rate: **9600**

Data bits: **7 Bits** Parity: **Even**

Stop bits: **1 Bit**

Parameter 1: **0** Turn around delay: **0**

Parameter 3: **0** Parameter 4: **0**

Parameter 5: **0** Parameter 6: **0**

HMI station no.: **0** PLC station no.: **0**

Multiple HMI: **Slave** HMI-HMI link speed: **115200**

Connect I/F: **Serial**

Local IP address: **0** - **0** - **0** - **0**

Server IP address: **0** - **0** - **0** - **0**

Subnetwork mask: **0** - **0** - **0** - **0**

Default route IP address: **0** - **0** - **0** - **0**

PLC time out constant (sec): **3.0** PLC block pack: **0**

OK **Cancel**

PLC Address View

MITSUBISHI FX0n/FX2

PLC/Address	Type	ID	Bit/Word	Address Type	Addressing Format	Max	Min
MITSUBISHI FX0n/FX2			PLC ID=10				
0	Bit(HMI)		LB	ddd		9999	0
1	Bit(PLC)		X	ooo		377	0
2	Bit(PLC)		Y	ooo		377	0
3	Bit(PLC)		M	ddd		9999	0
4	Bit(PLC)		T	ddd		255	0
5	Bit(PLC)		C	ddd		255	0
8	Word(HMI)		LW	ddd		9999	0
9	Word(PLC)		TV	ddd		255	0
10	Word(PLC)		CV	ddd		199	0
11	Word(PLC)		D	ddd		9999	0
12	Dword(PLC)		CV2	ddd		255	200
13	Word(PLC)		SD	ddd		9999	0000
121	Word(HMI)		RW	ddd		32767	0
120	Bit(HMI)		RBI	dddh		2047	0
140	Bit(HMI)		RB	dddh		2047	0
141	Word(HMI)		RW	ddd		65535	0
160	Bit(HMI)		Mx_RB	dddh		4095	0
161	Bit(HMI)		Mx_LB	ddd		9999	0
100	Word(HMI)		Mx_RW	ddd		65535	0

Exit

Device Address:

Bit/Word	MT500	MT8000	Range	Memo
B	Ms_RB	RW_Bit	ddd:0~4095 (h): 0~f	
B	Ms_LB	LB	dddd:0~9999	
W	Ms_RW	RW	ddd:0~65535	
W	Ms_LW	LW	ddd:0~9999	

Driver Version:

Version	Date	Description
V1.00	Dec/30/2008	Driver released.

Memobus (Yaskawa MP Series Controllers)

Supported series: YASKAWA MP2200, MP2300, MP2300S, MP9xx communication module.

Website: <http://www.yaskawa.com/>

HMI Setting:

Parameters	Recommend	Option	Notes
PLC type	Memobus (Yaskawa MP Series Controllers)		
PLC I/F	RS485/Ethernet	RS232/RS485 2w/4w, Ethernet	
Baud rate	19200	9600~57600	
Parity	Even		
Data bits	8		
Stop bits	1		
PLC st. no.	1	1-31	Must match the PLC's port setting.
Port no.	502	default	Ethernet Module only

PLC Setting:

Communication mode	MEMOBUS, Slave, RTU
--------------------	---------------------

PLC Ethernet Setting:

1. User MPE720 program software, Open Module Configuration. Double click "218IFA".

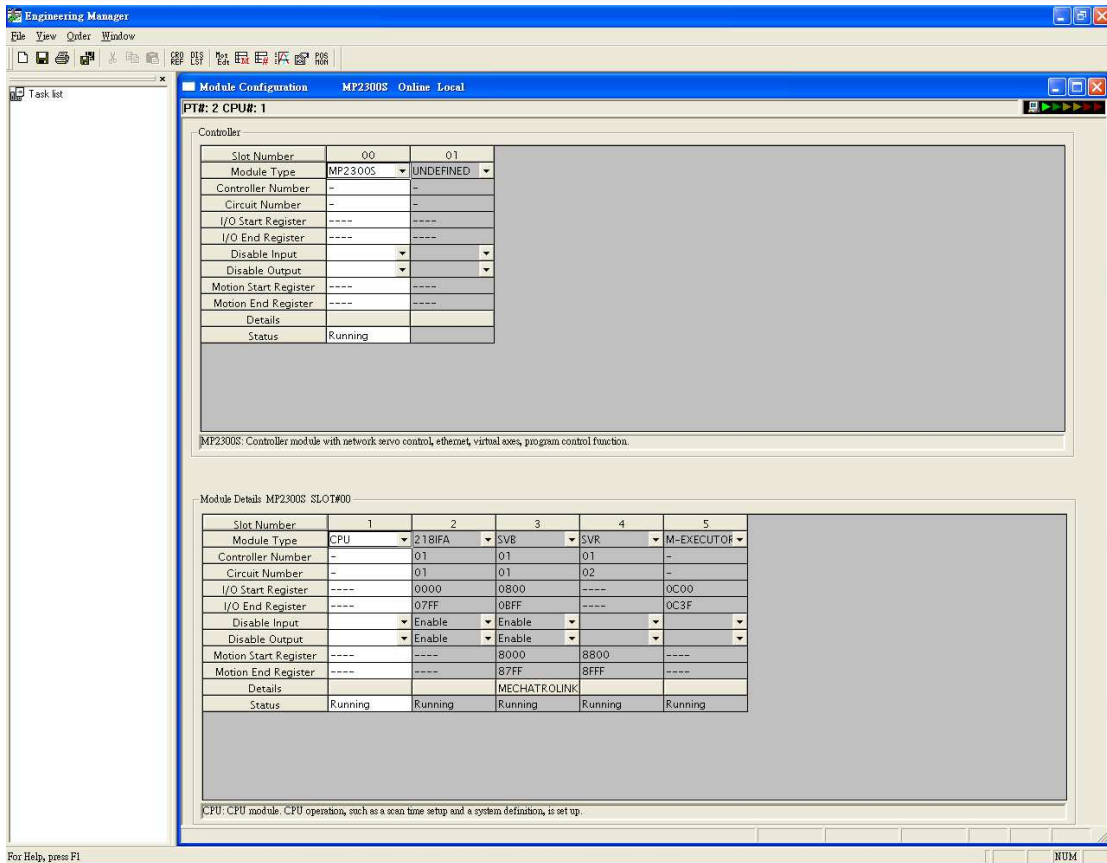

- In Transmission Parameters input MP2300S IP address, subnet Mask, Gateway IP. In Connection Parameter, CNO -1 input: Local Port=502, Node IP address=000.000.000.000, Node Port=00000, Connect Type=TCP, Protocol Type=MEMOBUS, Code=RTU.

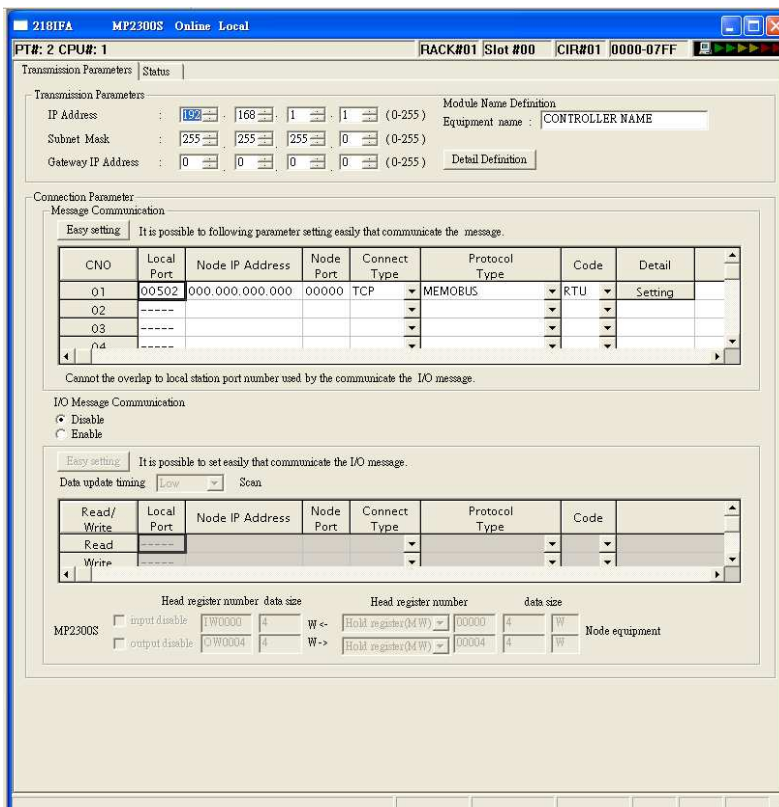

3. Click MECHATROLINK to set up MP2300S PLC as Master.

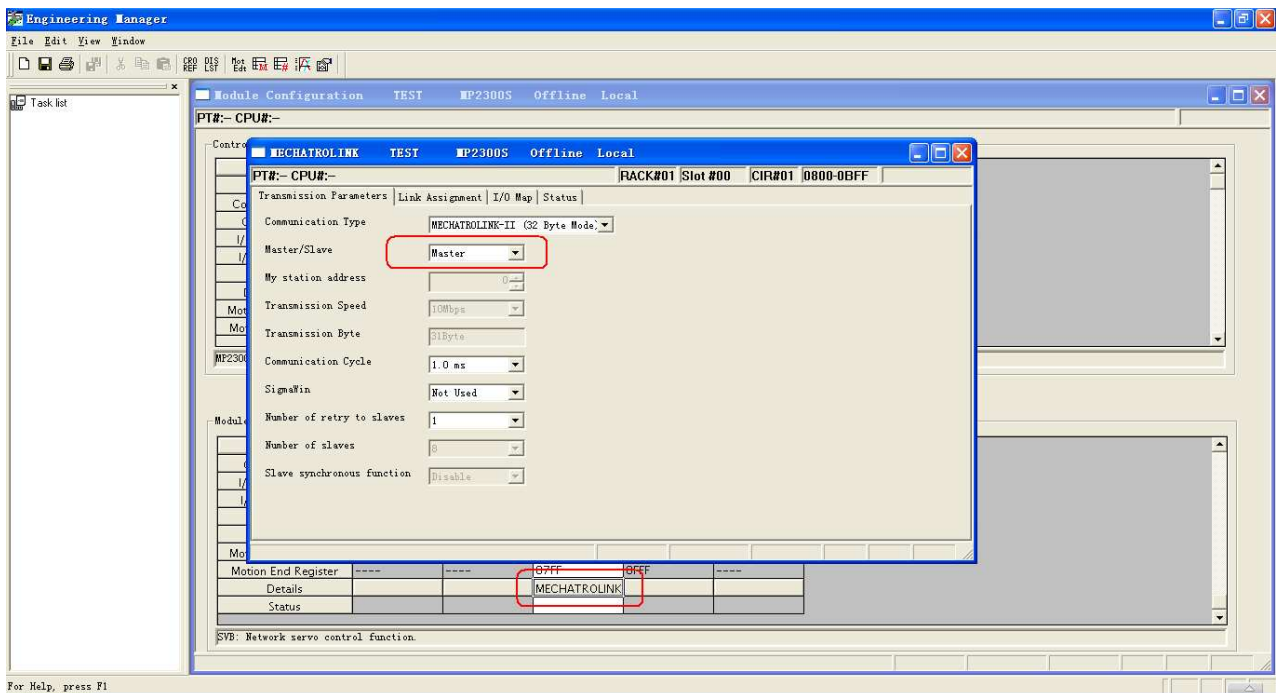

4. Close all dialogs and save to MP2300S.

Note:

1. Only CNO 01 able to auto communication with one HMI. Other CNO need create ladder program to communication.
2. DIP SW2-2 of MP2300S must be OFF position when normal communication, if it is ON position, IP address will be erased after reset power, and it is unable to communicate with HMI when ON position.

Device Address:

Bit/Word	Device type	Format	Range	Memo
B	MB_1	DDDDh	0 ~ 9999f	MB 0~9999
B	MB_2	DDDDDh	100000 ~ 65534f	MB 10000~65535
B	IB	HHHHH	0 ~ a7ff0	Read only
B	IW_Bit	HHHHdd	0~ a7ff15	
W	IW	HHHH	0 ~ a7ff	Read only
DW	IL	HHHH	0 ~ a7ff	Read only
F	IF	HHHH	0 ~ a7ff	Read only
W	MW	DDDDD	0 ~ 65534	Holding Register

DW	ML	DDDDD	0 ~ 65533	Double word
F	MF	DDDDD	0 ~ 65533	Floating point

*: When connect via Ethernet interface the max range of IW, IL and IF would be restricted.

Wiring Diagram:

9P D-Sub to 9P D-Sub: 217IF-01, 218IF-01

HMI COM1 RS232 9P D-Sub Male	HMI COM2 RS232 9P D-Sub Male	HMI COM3 RS232 9P D-Sub Female	217IF-01 RS232 9P D-Sub
2 RX	6 RX	8 RX	2 TX
3 TX	4 TX	7 TX	3 RX
5 GND	5 GND	5 GND	7 GND
			

217IF-01:

HMI COM1 RS485 2W 9P D-Sub Female	HMI COM3 RS485 2W 9P D-Sub Female		217IF-01 RS485 14P Connector
1 RX-	6 Data-		2, 4 D-
2 RX+	9 Data+		1, 3 D+
5 GND	5 GND		14 GND

217IF-01:

HMI COM1 RS485 4W 9P D-Sub Female			217IF-01 RS422 14P Connector
1 RX-			2 TX-
2 RX+			1 TX+
3 TX-			4 RX-
4 TX+			3 RX+
5 GND			14 GND

Direct connect (crossover cable):

HMI RJ45 Female	Wire Color	PLC RJ45 Female
1 TX+	White/Orange	3 RX+
2 TX-	Orange	6 RX-
3 RX+	White/Green	1 TX+
4 BD4+	Blue	4 BD4+
5 BD4-	White/Blue	5 BD4-
6 RX-	Green	2 TX-
7 BD3+	White/Brown	7 BD3+
8 BD3-	Brown	8 BD3-



Through a hub:

HMI RJ45 Female	Wire Color	PLC RJ45 Female
1 TX+	White/Orange	1 TX+
2 TX-	Orange	2 TX-
3 RX+	White/Green	3 RX+
4 BD4+	Blue	4 BD4+
5 BD4-	White/Blue	5 BD4-
6 RX-	Green	6 RX-
7 BD3+	White/Brown	7 BD3+
8 BD3-	Brown	8 BD3-



Driver Version:

Version	Date	Description
V1.70	Dec/20/2010	

Memory Map

Memory Map protocol is similar to IBM 3764R communication protocol. The EasyBuilder reserves 512 words of Data memory for use with this protocol. The EasyBuilder must update the values in these words. The EasyBuilder uses the words to display data and control parts status on its screen. When touch actions are taken, data is sent to the other once, and then update the memory in it. The HMI is always responsible for updating the Data memory.

HMI Setting:

Parameters	Recommend	Option	Notes
PLC type	Memory Map		
PLC I/F	RS232	RS232, RS485 4W, 2W	RS232 default
Baud rate	115200	9600~115200	
Parity	Even	Even, Odd, None	
Data bits	8		
Stop bits	1		

Device Address:

Bit/Word	Device type	Format	Range	Memo
B	MB	DDDDh	0 ~ 9999f	
W	MW	DDDD	0 ~ 9999	

The MB and MW are using same area to store data.

MW 0 = MB 000000 ~ MB 0000f

MW 1 = MB 000100 ~ MB 0001f

Wiring Diagram:

9P D-Sub to 9P D-Sub:

HMI COM1 RS232 9P D-Sub Male			HMI COM1 RS232 9P D-Sub Male
2 RX			3 TX
3 TX			2 RX
5 GND			5 GND

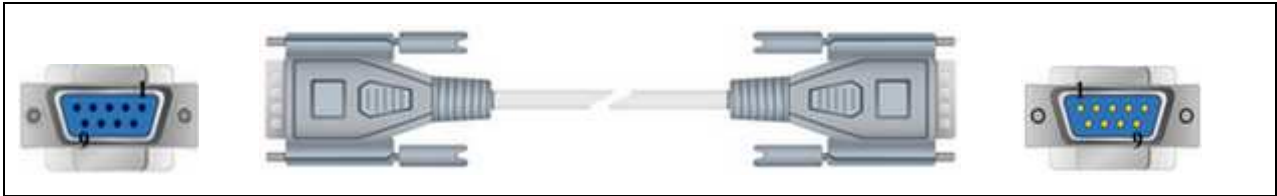

HMI COM1 RS485 2W 9P D-Sub Female			HMI COM1 RS485 2W 9P D-Sub Female
1 RX-			1 RX-
2 RX+			2 RX+
5 GND			5 GND

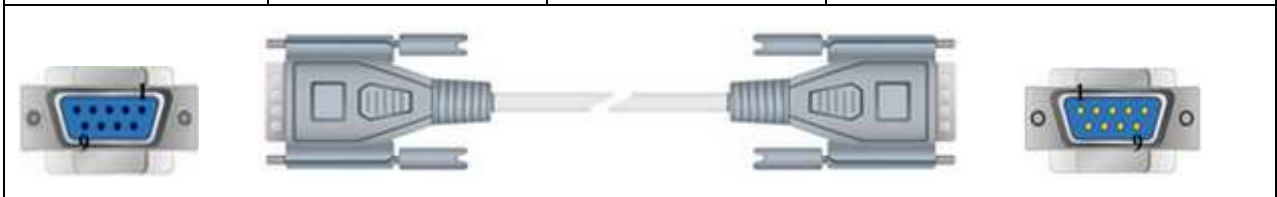

HMI COM1 RS485 4W 9P D-Sub Female			HMI COM1 RS485 4W 9P D-Sub Female
1 RX-			3 TX-
2 RX+			4 TX+
3 TX-			1 RX-
4 TX+			2 RX+
5 GND			5 GND

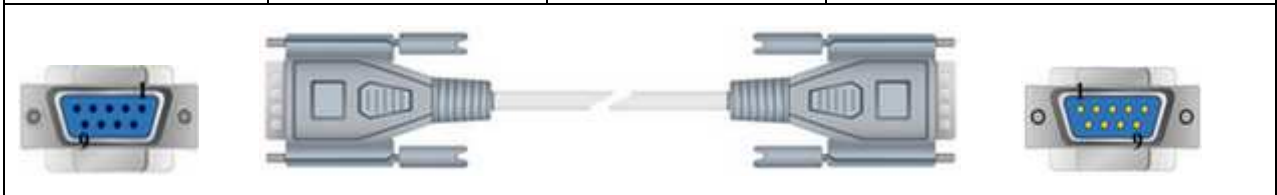

Note:

For Memory map information, please refer to user manual [chapter 31 Memory Map communication].

Driver Version:

Version	Date	Description
V1.00	Mar/19/2009	Driver released.

mitsubishi A1S

Supported series: MITSUBISHI A1S

Website: <http://www.mitsubishi-automation.com/>

HMI Setting:

Parameters	Recommend	Option	Notes
PLC type	mitsubishi A1S		
PLC I/F	RS232		
Baud rate	9600		
Parity	Odd		
Data bits	8		
Stop bits	1		
PLC st. no.	0		

Device Address:

Bit/Word	Device type	Format	Range	Memo
B	X	HHHH	0 ~ ffff	Input Relay
B	Y	HHHH	0 ~ ffff	Output Relay
B	M	DDDDD	0 ~ 65535	Auxiliary Relay
B	B	HHHH	0 ~ ffff	
B	F	DDDDD	0 ~ 65535	
W	TV	DDDDD	0 ~ 65535	Timer Memory
W	CV	DDDDD	0 ~ 65535	Counter Memory
W	D	DDDDD	0 ~ 65535	Data Register
W	W	HHHH	0 ~ ffff	
W	R	DDDDD	0 ~ 65535	

Wiring Diagram:

Use the RS422 to RS232 PLC programming cable (show as follows)

MITSUBISHI AnS CPU

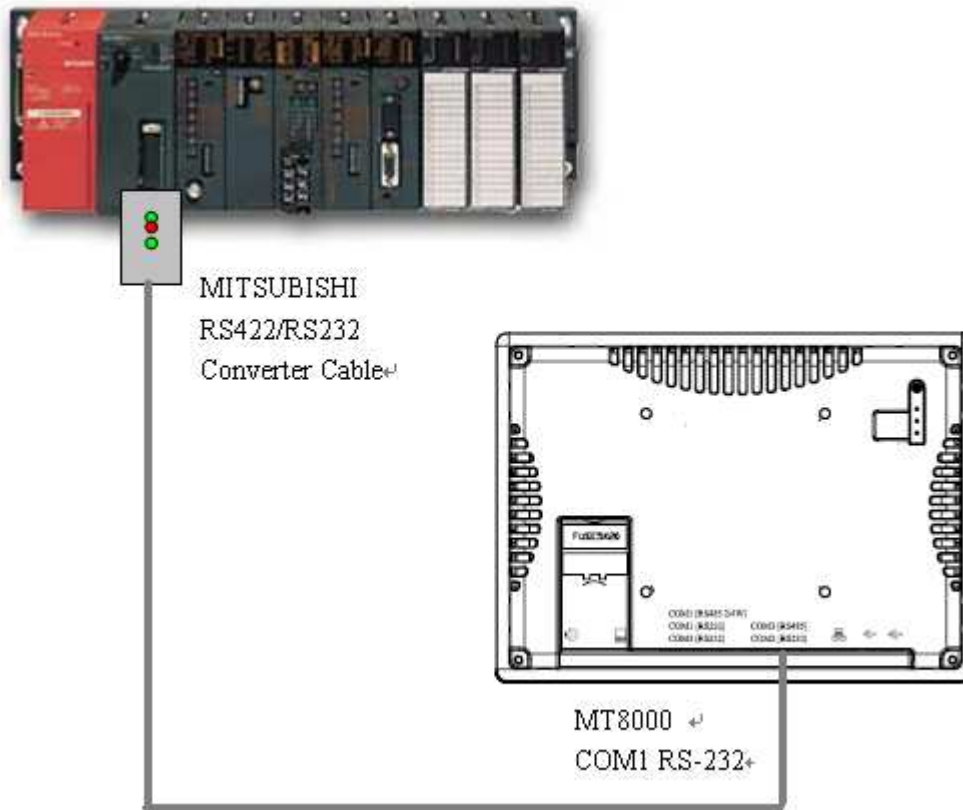

HMI COM1 RS232 9P D-Sub Male	PLC Programing Cable	Mitsubishi RS422 25P D-Sub
3 TD	RD	2 RX+
2 RD	TD	3 TX+
5 GND	GND	4 DSR+
8 CTS	RTS	7 GND
7 RTS	CTS	15 RX-
		16 TX-
		17 DSR-

Driver Version:

Version	Date	Description
V1.00	Sep/18/2009	Driver released.

mitsubishi A2A

Supported series: MITSUBISHI A2A, A2USH

Website: <http://www.mitsubishi-automation.com/>

HMI Setting:

Parameters	Recommend	Option	Notes
PLC type	mitsubishi A2A		
PLC I/F	RS232		
Baud rate	9600		
Parity	Odd		
Data bits	8		
Stop bits	1		
PLC st. no.	0		

Device Address:

Bit/Word	Device type	Format	Range	Memo
B	X	HHHH	0 ~ 270f	Input Relay
B	Y	HHHH	0 ~ 270f	Output Relay
B	M	DDDD	0 ~ 9999	Auxiliary Relay
B	B	HHHH	0 ~ ffff	
B	F	DDDDD	0 ~ 65535	
W	TV	DDD	0 ~ 255	Timer Memory
W	CV	DDD	0 ~ 255	Counter Memory
W	D	DDDD	0 ~ 9999	Data Register
W	W	HHHH	0 ~ ffff	
W	R	DDDDD	0 ~ 65535	

Wiring Diagram:

Use the RS422 to RS232 PLC programming cable (show as follows)

MITSUBISHI AnS CPU

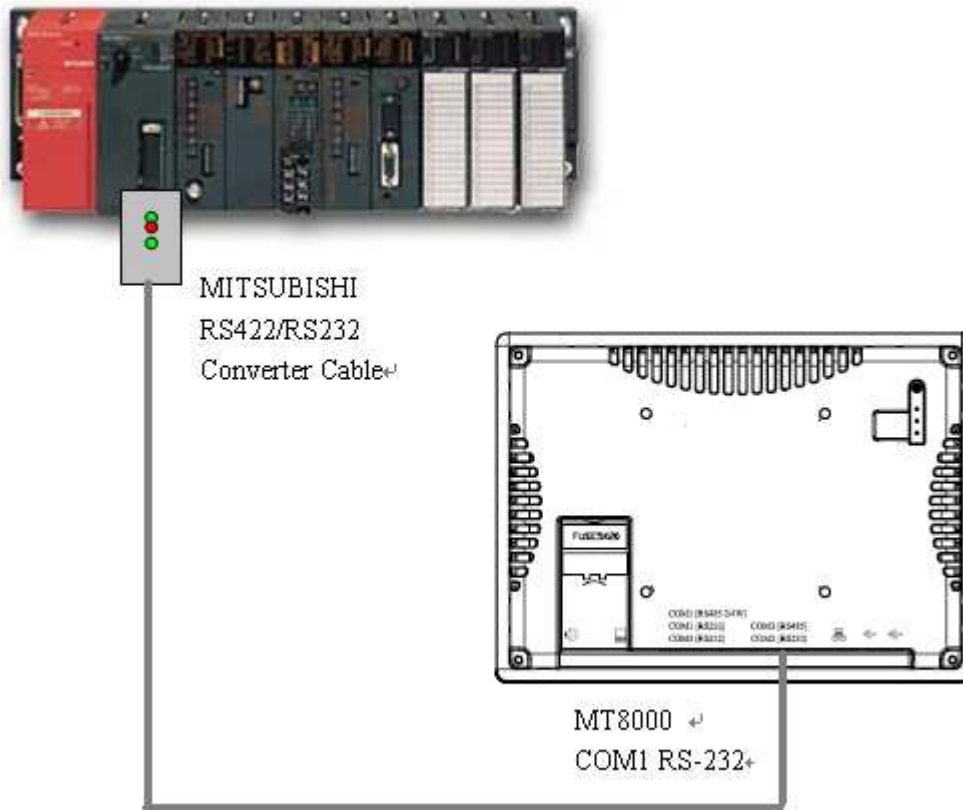

HMI COM1 RS232 9P D-Sub Male	PLC Programing Cable	Mitsubishi RS422 25P D-Sub
3 TD	RD	2 RX+
2 RD	TD	3 TX+
5 GND	GND	4 DSR+
8 CTS	RTS	7 GND
7 RTS	CTS	15 RX-
		16 TX-
		17 DSR-

Driver Version:

Version	Date	Description
V1.00	Aug/12/2009	Driver released.

MITSUBISHI A2US

Supported series: MITSUBISHI A2US

Website: <http://www.mitsubishi-automation.com/>

HMI Setting:

Parameters	Recommend	Option	Notes
PLC type	MITSUBISHI A2US		
PLC I/F	RS232		
Baud rate	9600		
Parity	Odd		
Data bits	8		
Stop bits	1		
PLC st. no.	0		

Device Address:

Bit/Word	Device type	Format	Range	Memo
B	X	HHHH	0 ~ 270f	Input Relay
B	Y	HHHH	0 ~ 270f	Output Relay
B	M	DDDD	0 ~ 9999	Auxiliary Relay
W	TV	DDD	0 ~ 255	Timer Memory
W	CV	DDD	0 ~ 255	Counter Memory
W	D	DDDD	0 ~ 9999	Data Register

Wiring Diagram:

Use the RS422 to RS232 PLC programming cable (show as follows)

MITSUBISHI AnS CPU

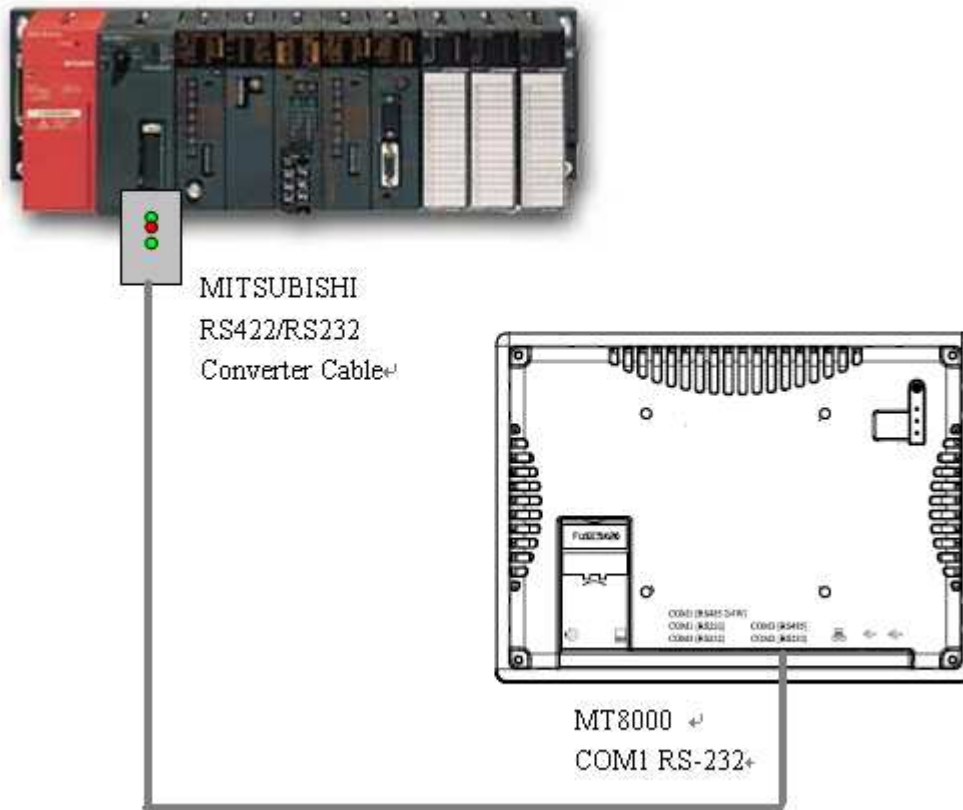

HMI COM1 RS232 9P D-Sub Male	PLC Programing Cable	Mitsubishi RS422 25P D-Sub
3 TD	RD	2 RX+
2 RD	TD	3 TX+
5 GND	GND	4 DSR+
8 CTS	RTS	7 GND
7 RTS	CTS	15 RX-
		16 TX-
		17 DSR-

Driver Version:

Version	Date	Description
V1.00	Mar/20/2009	Driver released.

mitsubishi A3N/A1SH

Supported series: MITSUBISHI A3N/A3A/A1SH/A2SH

Website: <http://www.mitsubishi-automation.com/>

HMI Setting:

Parameters	Recommend	Option	Notes
PLC type	mitsubishi A3N/A1SH		
PLC I/F	RS485 4W		
Baud rate	9600		
Parity	Odd		
Data bits	8		
Stop bits	1		
PLC st. no.	0		

Note: This driver is not available for On-line Simulation.

Device Address:

Bit/Word	Device type	Format	Range	Memo
B	X	HHHH	0 ~ ffff	Input Relay
B	Y	HHHH	0 ~ ffff	Output Relay
B	M	DDDDD	0 ~ 65535	Auxiliary Relay
B	B	HHHH	0 ~ ffff	
B	F	DDDDD	0 ~ 65535	
W	TV	DDDDD	0 ~ 65535	Timer Memory
W	CV	DDDDD	0 ~ 65535	Counter Memory
W	D	DDDDD	0 ~ 65535	Data Register
W	W	HHHH	0 ~ ffff	
W	R	DDDDD	0 ~ 65535	

Wiring Diagram:

Use the RS422 to RS232 PLC programming cable (show as follows)

MITSUBISHI AnS CPU

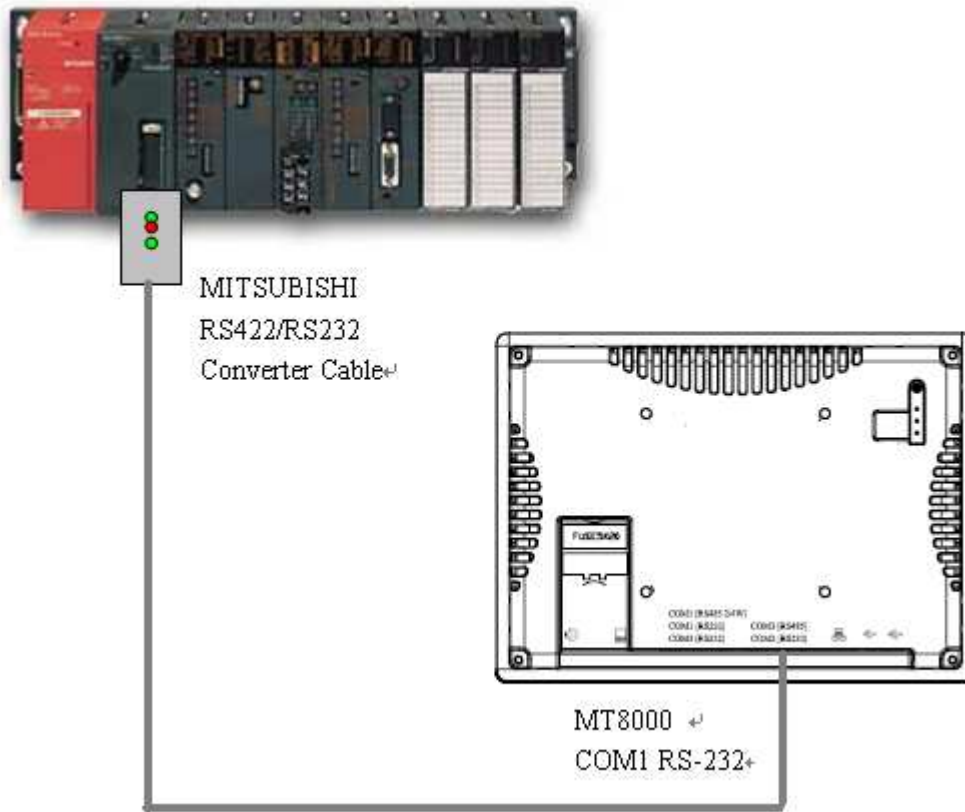

HMI COM1 RS232 9P D-Sub Male	PLC Programing Cable	Mitsubishi RS422 25P D-Sub
3 TD	RD	2 RX+
2 RD	TD	3 TX+
5 GND	GND	4 DSR+
8 CTS	RTS	7 GND
7 RTS	CTS	15 RX-
		16 TX-
		17 DSR-

Driver Version:

Version	Date	Description
V1.00	Oct/20/2009	Driver released.

mitsubishi AJ71

Supported series: Mitsubishi A series PLC with AJ71C24 communication module using the Computer Link protocol.

Website: <http://www.mitsubishi-automation.com>

HMI Setting:

Parameters	Recommend	Option	Notes
PLC type	mitsubishi AJ71	mitsubishi AJ71 (AnA/AnU CPU), mitsubishi AJ71 (Format 4)	
PLC I/F	RS485 4W	RS485 4W, RS232	
Baud rate	19200	9600, 19200	
Parity	Even	Even, Odd, None	
Data bits	8	8	
Stop bits	1	1	
PLC st. no.	0		

PLC Setting:

Communication mode	Computer Link protocol 9600, Even, 8, 1 (default)
Mode Setting Switch	Format 1
Parity Check	Enable
Sum Check	Enable

Device Address:

Bit/Word	Device type	Format	Range	Memo
B	X	HHHH	0 ~ ffff	Input Bits
B	Y	HHHH	0 ~ ffff	Output Bits
B	M	DDDDD	0 ~ 65535	Internal Relays
B	T	DDDDD	0 ~ 65535	
B	C	DDDDD	0 ~ 65535	
B	B	HHHH	0 ~ ffff	
B	F	DDDDD	0 ~ 65535	

W	TV	DDDDD	0 ~ 65535	Timer Preset Value
W	CV	DDDDD	0 ~ 65535	Counter Preset Value
W	D	DDDDD	0 ~ 65535	Data Registers
W	W	HHHH	0 ~ ffff	
W	R	DDDDD	0 ~ 65535	

Wiring Diagram:

HMI COM1 RS485 4W 9P D-Sub Female			AJ71C24 RS422
1 RX-			SDB
2 RX+			SDA
3 TX-			RDB
4 TX+			RDA
5 GND			GND

HMI COM1 RS232 9P D-Sub Male	HMI COM2 RS232 9P D-Sub Male	HMI COM3 RS232 9P D-Sub Female	A1SJ71UC24-R2 RS232 9P D-Sub
2 RX	6 RX	8 RX	3 TXD
3 TX	4 TX	7 TX	2 RXD
5 GND	5 GND	5 GND	5 GND
			1 DCD
			4 DTR
			6 DSR
			7 RTS
			8 CTS

Driver Version:

Version	Date	Description
V1.50	Mar/11/2010	

MITSUBISHI FX0n/FX2

Supported series: Mitsubishi FX0s/FX0n/FX1s/FX2 PLC

Website: <http://www.mitsubishi-automation.com>

HMI Setting:

Parameters	Recommend	Option	Notes
PLC type	Mitsubishi FX0n/FX2		
PLC I/F	RS485 4W	RS232/RS485	
Baud rate	9600	9600/19200/38400/ 57600/115200	
Parity	Even	Even, Odd, None	
Data bits	7	7,8	
Stop bits	1	1,2	
PLC st. no.	0	0-255	must same as the PLC setting

Device Address:

Bit/Word	Device type	Format	Range	Memo
B	X	OOO	0 ~ 377	Input Relay
B	Y	OOO	0 ~ 377	Output Relay
B	M	DDDD	0 ~ 9999	Auxiliary Relay
B	T	DDD	0 ~ 255	Timer Relay
B	C	DDD	0 ~ 255	Counter Relay
B	D_Bit	DDDDdd	0 ~ 999915	Data Register Bit (D)
B	S	DDDD	0 ~ 4095	States
B	SM	DDDD	8000 ~ 9999	Special Aux. Relays
W	TV	DDD	0 ~ 255	Timer Memory
W	CV	DDD	0 ~ 199	Counter Memory
W	D	DDDD	0 ~ 9999	Data Register
DW	CV2	DDD	200 ~ 255	Counter Memory(D Word)
W	SD	DDDD	8000 ~ 9999	Special Data Register

Wiring Diagram:

9P D-Sub to 8P MiniDIN:

HMI COM1 RS485 4W 9P D-Sub Female			Mitsubishi PLC CPU RS422 Port 8P Mini-DIN
1 RX-			4 TX-
2 RX+			7 TX+
3 TX-			1 RX-
4 TX+			2 RX+
5 GND			3 GND



9P D-Sub to 25P D-Sub:

HMI COM1 RS485 4W 9P D-Sub Female			Mitsubishi PLC CPU RS422 Port 25P D-Sub	
1 RX-			16 TXD-	
2 RX+			3 TXD+	
3 TX-			15 RXD-	
4 TX+			2 RXD+	
5 GND			7 GND	circuit
			4 DSR+	
			8 GND	circuit
			13 +5V	
			17 DSR-	



Driver Version:

Version	Date	Description
V1.10	Sep/ 01/2009	Add address type [S], [SM], [D_bit].

mitsubishi FX232/485BD

Supported series: Mitsubishi FX0n/FX2/FX2n COM For Communication Module BD
FX2N-485-BD, FX2N-232-BD, FX1N-485-BD and FX1N-232-BD.

Website: <http://www.mitsubishi-automation.com>

HMI Setting:

Parameters	Recommend	Option	Notes
PLC type	mitsubishi FX232/485BD		
PLC I/F	RS232/RS485	RS232/RS485 2w/4w	in accordance with the BD module
Baud rate	19200	9600/19200	
Parity	Even	Even, Odd, None	
Data bits	7	7,8	
Stop bits	1	1,2	
PLC st. no.	1	0-15	

Note: we suggest the turn around delay to set 8. (For i series HMI)

Online Simulator	YES	Extend address mode	YES
------------------	-----	---------------------	-----

PLC Setting:

Communication mode	Must set PLC station when use the BD Module
--------------------	---

Register D8120 setting: set b9 and b8 of BFM#0 as 0

FX2N-485-BD, FX1N-485-BD

FX2N-232-BD, FX1N-232-BD

Device Address:

Bit/Word	Device type	Format	Range	Memo
B	X	OOO	0 ~ 377	Input Relay
B	Y	OOO	0 ~ 377	Output Relay
B	M	DDDD	0 ~ 7999	Auxiliary Relay
B	T	DDD	0 ~ 511	Timer Relay
B	C	DDD	0 ~ 255	Counter Relay
B	SM	DDDD	8000 ~ 9999	
W	TV	DDD	0 ~ 255	Timer Memory
W	CV	DDD	0 ~ 199	Counter Memory
W	D	DDDD	0 ~ 7999	Data Register
W	CV2	DDD	200 ~ 255	Counter Memory(D Word)
W	SD	DDDD	8000 ~ 9999	

Wiring Diagram:

9P D-Sub to 9P D-Sub: Communication Module RS232BD

HMI COM1 RS232 9P D-Sub Male	HMI COM2 RS232 9P D-Sub Male	HMI COM3 RS232 9P D-Sub Female	232BD Module RS232 9P D-Sub
2 RX	6 RX	8 RX	3 TXD
3 TX	4 TX	7 TX	2 RXD
5 GND	5 GND	5 GND	5 GND

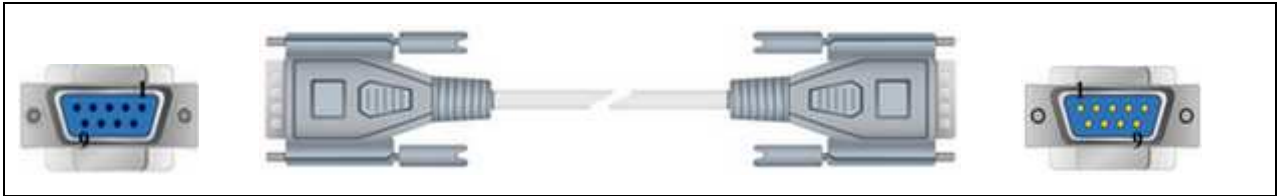
9P D-Sub to 5P Terminals: Communication Module RS485BD

HMI COM1 RS485 4W 9P D-Sub Female			485BD Module 5P Termanals
1 RX-			SDB
2 RX+			SDA
3 TX-			RDB
4 TX+			RDA
5 GND			SG

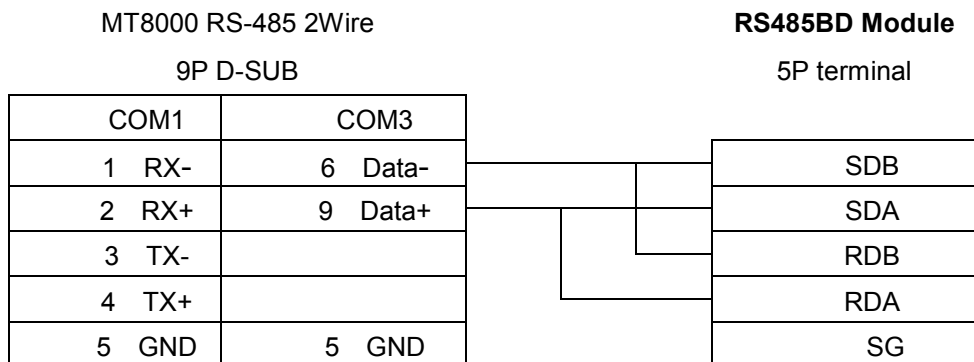
Communication Module RS485BD:

Driver Version:

Version	Date	Description
V1.20	Feb/06/2010	

MITSUBISHI FX2n

Supported series: Mitsubishi FX1n/FX2n series PLC

Website <http://www.mitsubishi-automation.com>

HMI Setting:

Parameters	Recommend	Option	Notes
PLC type	MITSUBISHI FX2n		
PLC I/F	RS485 4W	RS232/RS485	
Baud rate	19200	9600/19200/38400 /57600/115200	
Parity	Even		
Data bits	7		
Stop bits	1		
PLC st. no.	0		

Online Simulator	YES	Extend address mode	NO
------------------	-----	---------------------	----

Device Address:

Bit/Word	Device type	Format	Range	Memo
B	X	OOO	0 ~ 377	Input Relay
B	Y	OOO	0 ~ 377	Output Relay
B	M	DDDD	0 ~ 7999	Auxiliary Relay
B	T	DDD	0 ~ 255	Timer Relay
B	C	DDD	0 ~ 255	Counter Relay
B	SM	DDDD	8000 ~ 9999	Special Auxiliary Relay
B	D_Bit	DDDDdd	0 ~ 799915	Data Register Bit (D)
B	S	DDDD	0 ~ 4095	State Relay (S)
W	TV	DDD	0 ~ 255	Timer Memory
W	CV	DDD	0 ~ 199	Counter Memory
W	D	DDDD	0 ~ 7999	Data Register
DW	CV2	DDD	200 ~ 255	Counter Memory(D Word)
W	SD	DDDD	8000 ~ 9999	Special Data Register

Wiring Diagram:

9P D-Sub to 8P Mini-DIN:

HMI COM1 RS485 4W 9P D-Sub Female			Mitsubishi FX series PLC CPU Port RS422 8P Mini-DIN
1 RX-			4 TX-
2 RX+			7 TX+
3 TX-			1 RX-
4 TX+			2 RX+
5 GND			3 GND



Driver Version:

Version	Date	Description
V1.60	Sep/10/2009	

MITSUBISHI FX3u (Ethernet)

Supported series: MITSUBISHI FX SERIES, Module: FX3U-ENET.

Website: <http://www.mitsubishi-automation.com>

HMI Setting:

Parameters	Recommend	Option	Notes
PLC type	MITSUBISHI FX3u (Ethernet)		
PLC I/F	Ethernet		
PLC st. no.	0 (default)		Refer Module Setting
Port no.	5001(default)		Refer Module Setting

PLC Setting:

Fx3u-ENET module setting:

Before using Ethernet module, using GX Developer / FX Configurator-EN to set the Ethernet module, the FX3u-ENET module settings as below steps.

1. Open GX Developer, select “Read from PLC” in Online list.

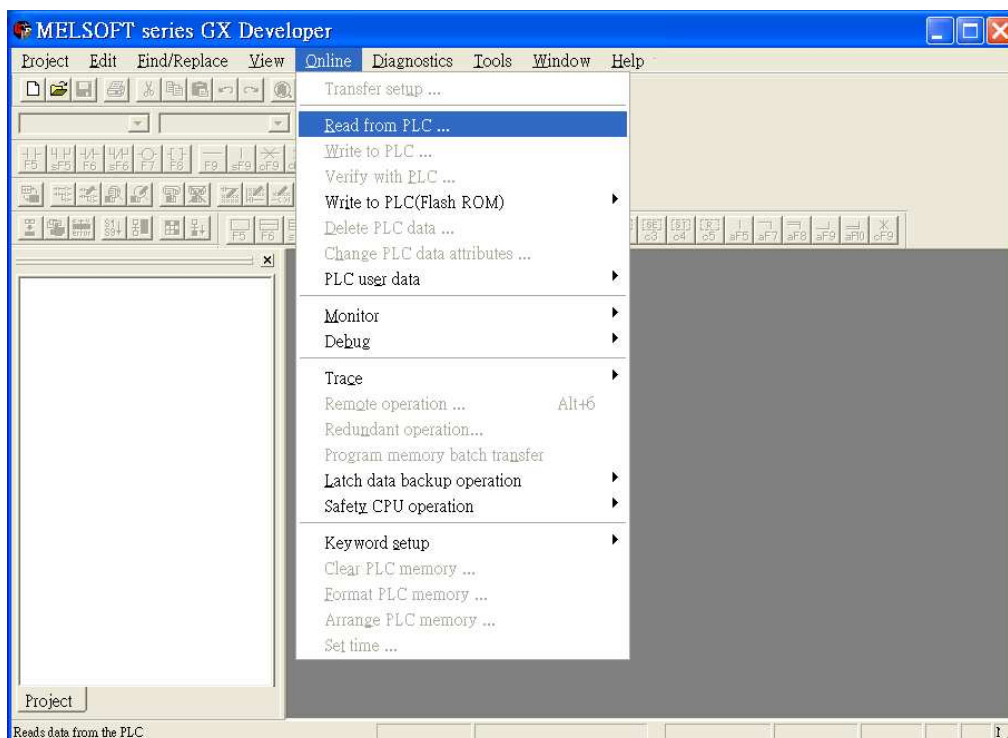

2. Select "FXCPU" in PLC series.



3. Users have to connect PLC via series port for setting IP address at first time.

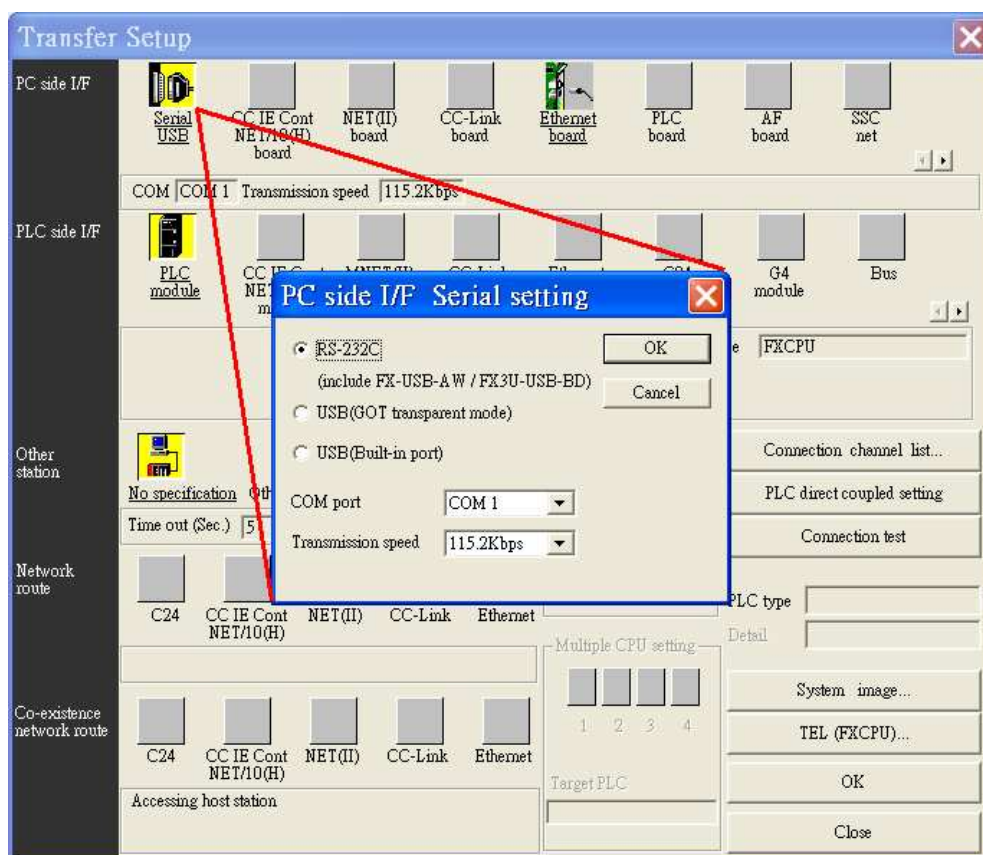

4. After finishing the PLC settings, select Tools/FX special function utility/FX Configurator-EN.

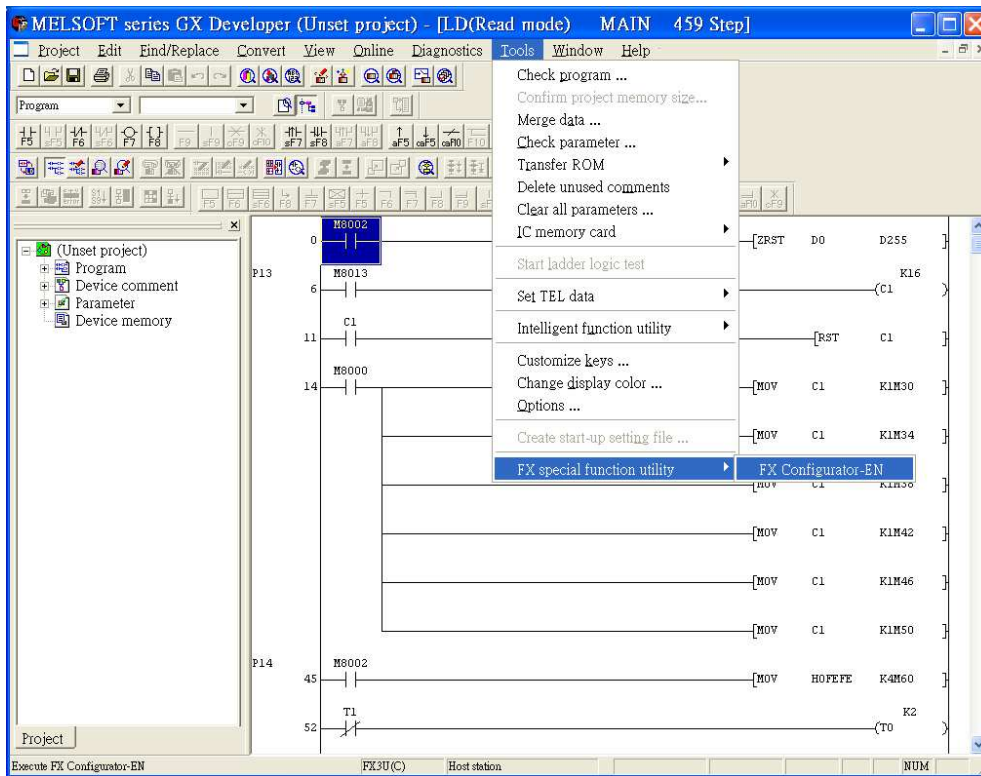

5. Select "Module 0" in Ethernet Module settings.
(If more than one module, please setting modules step by step)

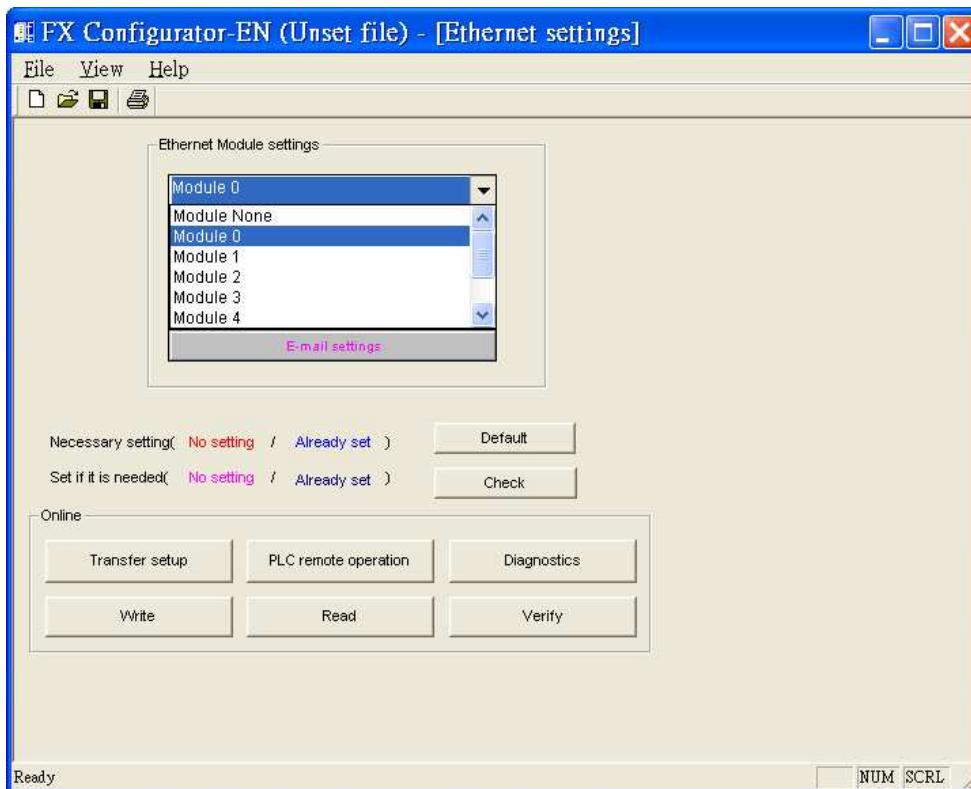

- In Ethernet operational settings, select the related parameters and IP address and then press "End" to finish the settings.

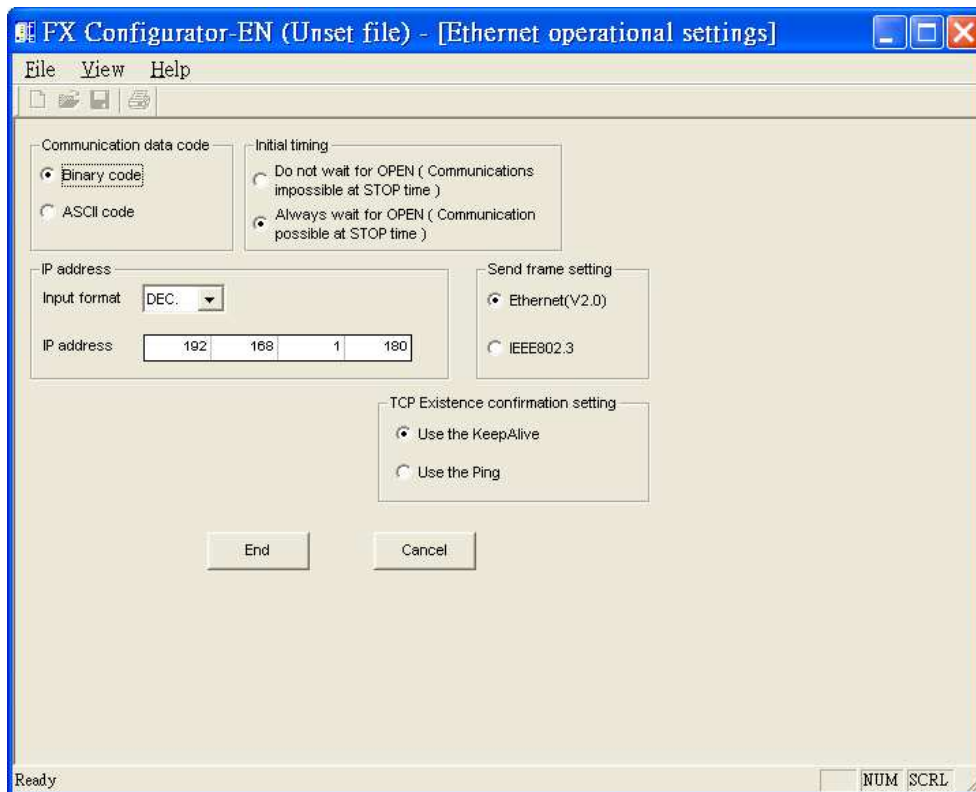

- In Ethernet open settings, press "End" after setting the below parameters.

1	TCP	MELSOFT connection						
2	TCP	Unpassive	Send	Procedure exist(MC)	Disable	No confirm	5001	
3	TCP	Unpassive	Send	Procedure exist(MC)	Disable	No confirm	5001	
4	TCP	Unpassive	Send	Procedure exist(MC)	Disable	No confirm	5001	

(The first Protocol means using GX Developer to communicate with module, The max. "Fixed buffer communication procedure" is 4 units.)

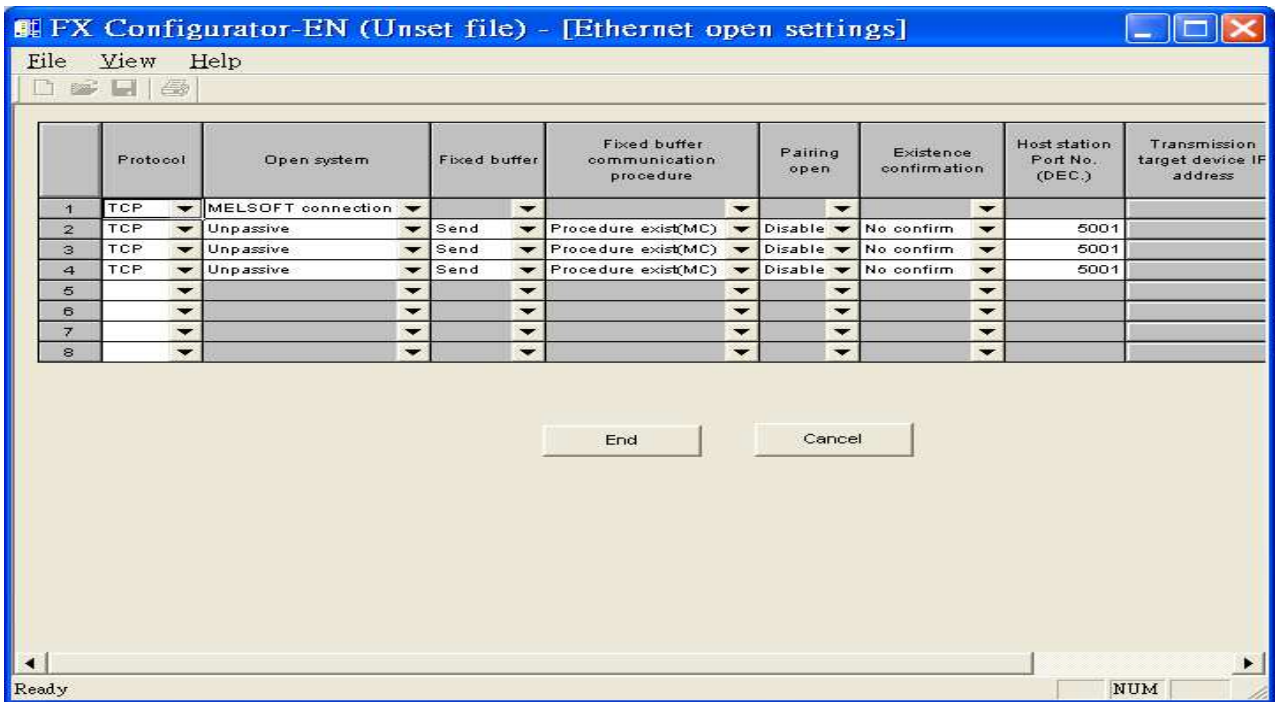

Or

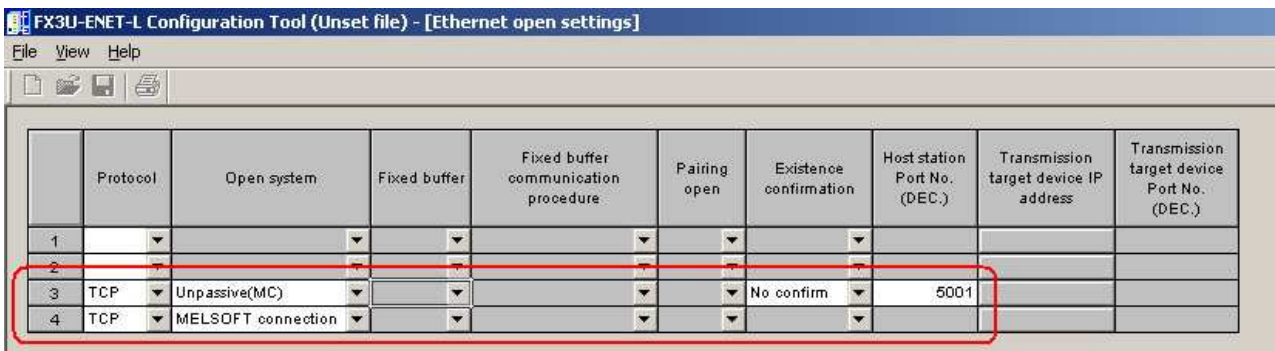

7. After setting the parameters to PLC, restart for using Ethernet communication.

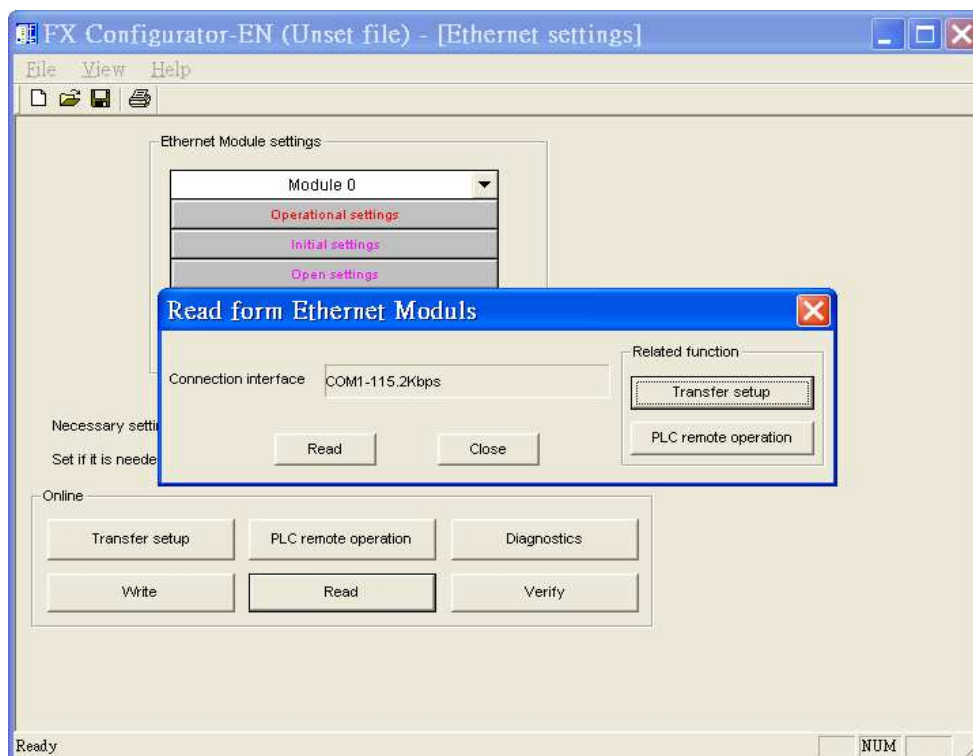

Device Address:

Bit/Word	Device type	Format	Range	Memo
B	X	OOO	0 ~ 571	Input
B	Y	OOO	0 ~ 571	Output Relay
B	M	DDDD	0 ~ 7999	Internal Relay
B	S	DDDD	0 ~ 4095	Step Relays
B	T	DDD	0 ~ 511	Timer Contacts
B	C	DDD	0 ~ 255	Counter Contacts
B	SM	DDDD	8000 ~ 8511	Special Int. Relays
B	D_Bit	DDDDdd	0 ~ 1799915	Data Register Bit Access
W	TV	DDD	0 ~ 511	Timer Value
W	R	DDDDD	0 ~ 32767	File Register
W	CV	DDD	0 ~ 199	Counter Value
W	D	DDDD	0 ~ 7999	Data Registers
W	CV2	DDD	200 ~255	Counter Value
W	SD	DDDD	8000 ~ 8511	Special Data Registers

Wiring Diagram:

Direct connect (crossover cable):

HMI RJ45 Female	Wire Color	PLC RJ45 Female
1 TX+	White/Orange	3 RX+
2 TX-	Orange	6 RX-
3 RX+	White/Green	1 TX+
4 BD4+	Blue	4 BD4+
5 BD4-	White/Blue	5 BD4-
6 RX-	Green	2 TX-
7 BD3+	White/Brown	7 BD3+
8 BD3-	Brown	8 BD3-



Through a hub:

HMI RJ45 Female	Wire Color	PLC RJ45 Female
1 TX+	White/Orange	1 TX+
2 TX-	Orange	2 TX-
3 RX+	White/Green	3 RX+
4 BD4+	Blue	4 BD4+
5 BD4-	White/Blue	5 BD4-
6 RX-	Green	6 RX-
7 BD3+	White/Brown	7 BD3+
8 BD3-	Brown	8 BD3-



Driver Version:

Version	Date	Description
V1.00	Feb/12/2009	Driver released.

MITSUBISHI FX3u/FX3G

Supported series : Mitsubishi FX3U/FX3UC/FX3G.

Website: <http://www.mitsubishi-automation.com>

HMI Setting:

Parameters	Recommend	Option	Notes
PLC type	MITSUBISHI FX3u/FX3G		
PLC I/F	RS485 4w	RS232/RS485 2w/4w	
Baud rate	38400	9600/19200	
Parity	Even		
Data bits	7		
Stop bits	1		
PLC st. no.	0		Does not apply to this protocol

Online Simulator	YES (9600 baud rate only)	Extend address mode	NO
------------------	---------------------------	---------------------	----

Device Address:

Bit/Word	Device type	Format	Range	Memo
B	X	OOO	0 ~ 764	Input Relay
B	Y	OOO	0 ~ 764	Output Relay
B	M	DDDD	0 ~ 7999	Auxiliary Relay
B	SM	DDDD	8000 ~ 9999	Special Relay (M)
B	S	DDDD	0 ~ 4095	State Relay (S)
B	T	DDD	0 ~ 511	Timer Relay (T)
B	C	DDD	0 ~ 255	Counter Relay (C)
B	D_Bit	DDDDdd	0 ~ 799915	Data Register Bit (D)
W	TV	DDD	0 ~ 511	Timer Memory (T)
W	CV	DDD	0 ~ 199	Counter Memory (C)
DW	CV2	DDD	200 ~ 255	Counter Memory(D Word)
W	D	DDDD	0 ~ 7999	Data Register (D)

Bit/Word	Device type	Format	Range	Memo
W	SD	DDDD	8000 ~ 9999	Special Data Register (D)
W	R	DDDDD	0 ~ 32767	Extended Register (R)
W	Z	D	0 ~ 7	Index register

Wiring Diagram:

9P D-Sub to 8P Mini-DIN:

HMI COM1 RS485 4W 9P D-Sub Female			Mitsubishi FX series PLC CPU Port RS422 8P Mini-DIN
1 RX-			4 TX-
2 RX+			7 TX+
3 TX-			1 RX-
4 TX+			2 RX+
5 GND			3 GND



Driver Version:

Version	Date	Description
V1.71	Nov/15/2010	

MITSUBISHI MELSEC-Q (Ethernet)

Supported series: MITSUBISHI Q series (Q03UDE, Q04UDEH, Q06UDEH, Q10UDEH, Q13UDEH, Q20UDEH, Q26UDEH), MELSEC-Q protocol application to CPU of Ethernet interface or Ethernet module.

Website: <http://www.mitsubishi-automation.com>

HMI Setting:

Parameters	Recommend	Option	Notes
PLC type	MITSUBISHI MELSEC-Q (Ethernet)		
PLC I/F	Ethernet		
PLC st. no.	It must same as the PLC setting	255	Q13UDEH has to set 255
Parameter1	Networking no. (it must the same as PLC setting)	0~255	Q13UDEH has to set 0
Port no.	It must same as the PLC setting		Advice to set port no. to 4999

PLC Setting:

MITSUBISHI Q series Ethernet module setting:

Remark: If using QJ71E71 module, please refer MITSUBISHI QJ71E71 connection guide.

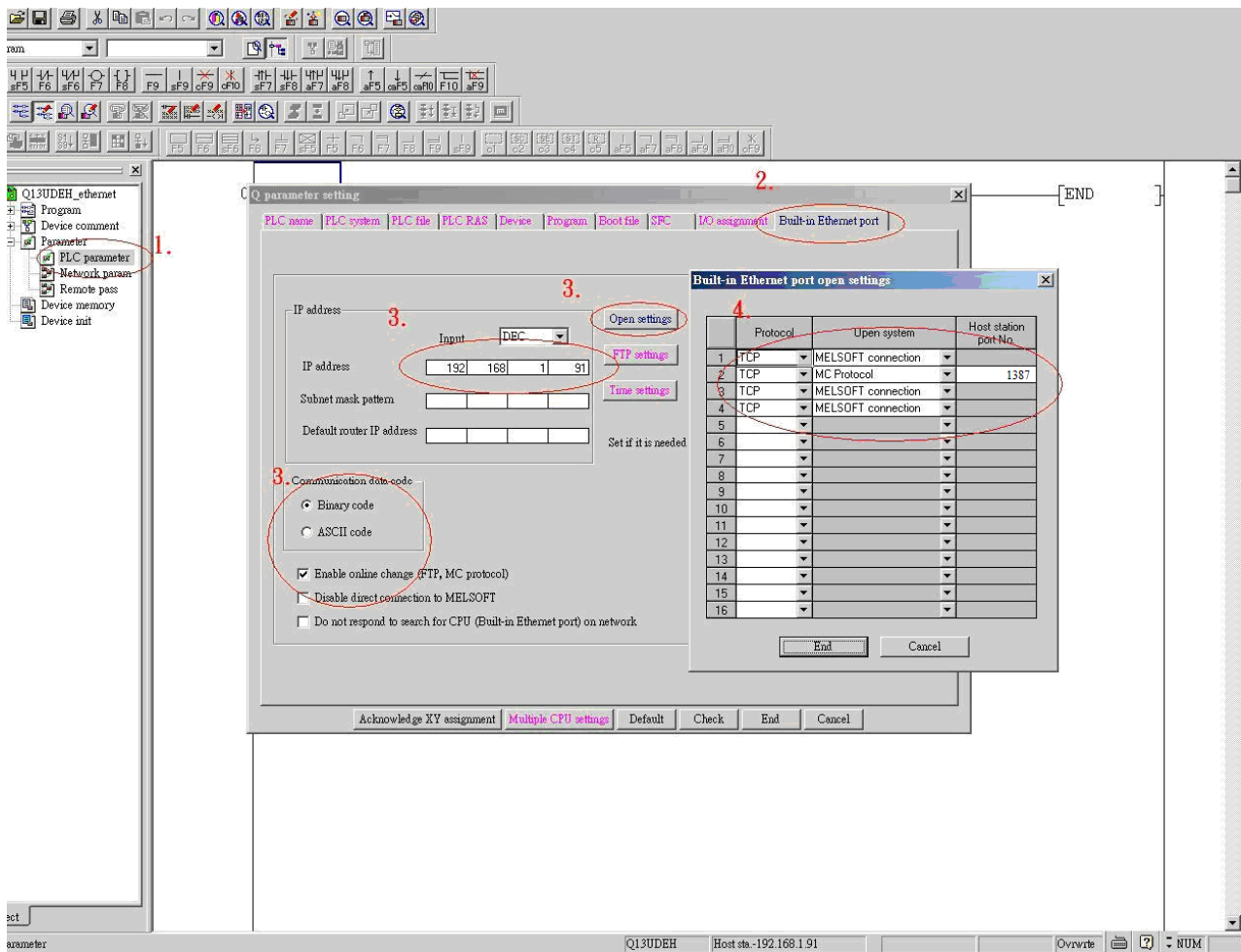

1. Click PLC parameter
2. Built-in Ethernet port.
3. Click Open settings and then set the IP address and communication data code
4. Set the MC protocol-TCP Port No.1387 (Hex) and in EasyBuilder TCP port is 4999 (Dec).

Note: In EasyBuilder, please fill in network no. in Parameter 1 as PLC setting. For example, from below picture, the Network no. is 2.

Module 1	
Network type	Ethernet
Starting I/O No.	0000
Network No.	2
Total stations	
Group No.	1
Station No.	1
Mode	On line
	Operational settings
	Initial settings
	Open settings
	Router relay parameter
	Station No.<->IP information
	FTP Parameters
	E-mail settings

Users have to set 2 in Parameter 1 in EasyBuilder.

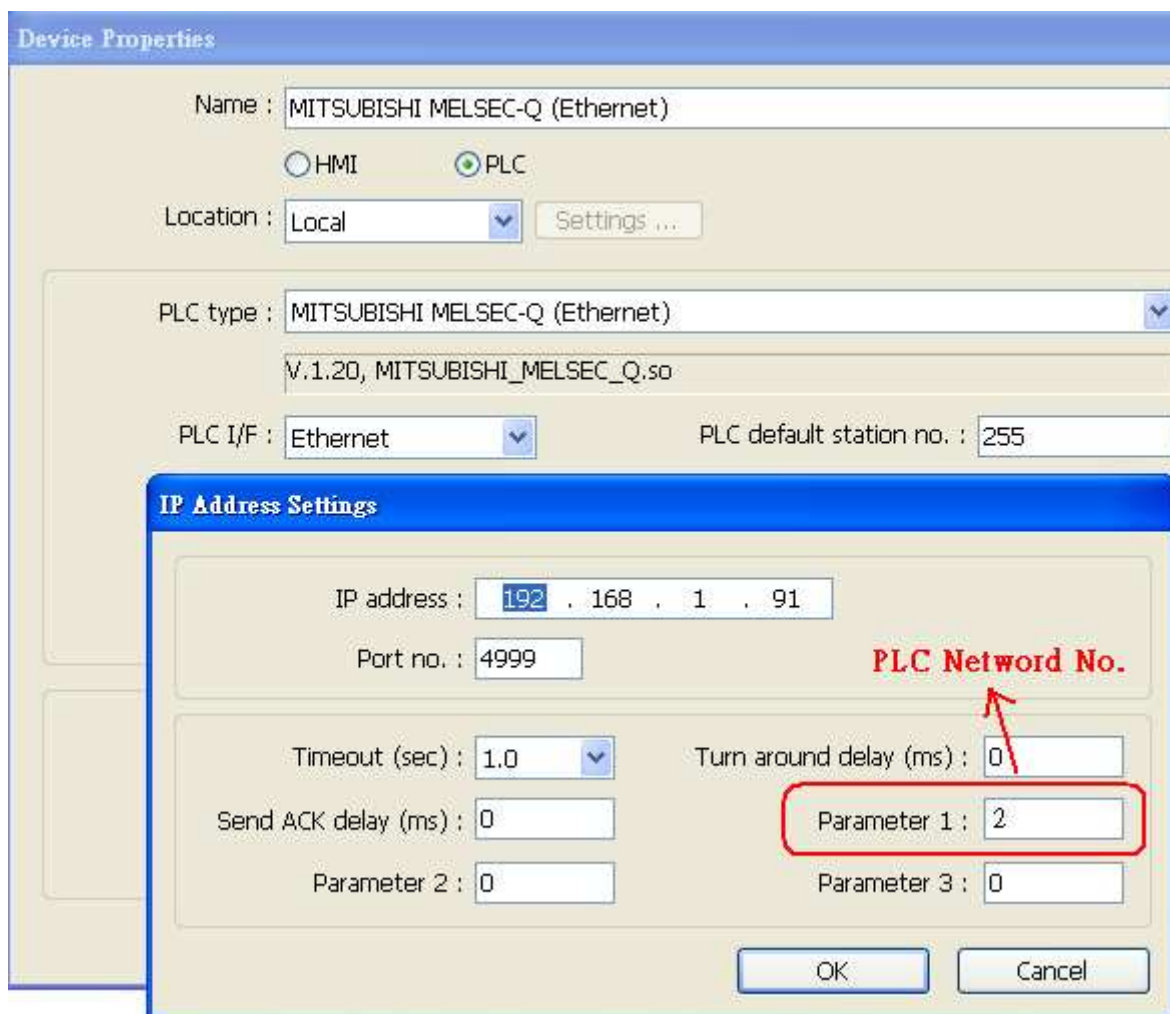

Device Address:

Bit/Word	Device type	Format	Range	Memo
B	SM	DDDD	0 ~ 2047	Special Relay
B	X	HHHH	0 ~ 1fff	Input Relay
B	Y	HHHH	0 ~ 1fff	Output Relay
B	M	DDDDD	0 ~ 61439	Internal Relay
B	L	DDDDD	0 ~ 32767	Latch Relay
B	F	DDDDD	0 ~ 32767	Annunciator
B	V	DDDDD	0 ~ 32767	Edge Relay
B	B	HHHH	0 ~ eff	Link Relay
B	TS	DDDDD	0 ~ 25471	Timer Contact
B	TC	DDDDD	0 ~ 25471	Timer Coil
B	SS	DDDDD	0 ~ 25471	Retentive Timer Contact
B	SC	DDDDD	0 ~ 25471	Retentive Timer Coil
B	CS	DDDDD	0 ~ 25471	Counter Contact
B	CC	DDDDD	0 ~ 25471	Counter Coil
B	SB	HHHH	0 ~ 7ff	Special Link Relay
B	S	DDDD	0 ~ 8191	Step relay
B	DX	HHHH	0 ~ 1ff	Direct Input
B	DY	HHHH	0 ~ 1ff	Direct Output
B	D_Bit	DDDDDDDDh	0 ~ 4184063f	Data Register bit
B	SD_bit	DDDDh	0 ~ 2047f	Special register Bit
B	ZR_bit	HHHHHHHh	0 ~ 3fd7fff	File Register Bit
B	R_bit	DDDDDDh	0 ~ 32767f	File Register Bit
B	SW_bit	HHHHh	0 ~ 7ff	Special Link Register Bit
B	W_bit	HHHHHHHh	0 ~ 3fd7fff	Link Register Bit
W	SD	DDDD	0 ~ 2047	Special register
W	D	DDDDDDDD	0 ~ 4184063	Data Register
W	W	HHHHHH	0 ~ 3fd7ff	Link Register
W	TN	DDDDD	0 ~ 25471	Timer Current value
W	SN	DDDDD	0 ~ 25471	Retentive Timer Current value
W	CN	DDDDD	0 ~ 25471	Counter Current value
W	SW	HHH	0 ~ 7ff	Special Link Register
W	Z	DD	0 ~ 20	Index Register
W	R	DDDDD	0 ~ 32767	File Register
W	ZR	HHHHHH	0 ~ 3fd7ff	File Register

Note: Every model of CPU is different, we suggest user to refer to MITSUBISHI MELSEC-Q manual's Device List.

Wiring Diagram:

Direct connect (crossover cable):

HMI RJ45 Female	Wire Color	PLC RJ45 Female
1 TX+	White/Orange	3 RX+
2 TX-	Orange	6 RX-
3 RX+	White/Green	1 TX+
4 BD4+	Blue	4 BD4+
5 BD4-	White/Blue	5 BD4-
6 RX-	Green	2 TX-
7 BD3+	White/Brown	7 BD3+
8 BD3-	Brown	8 BD3-



Through a hub:

HMI RJ45 Female	Wire Color	PLC RJ45 Female
1 TX+	White/Orange	1 TX+
2 TX-	Orange	2 TX-
3 RX+	White/Green	3 RX+
4 BD4+	Blue	4 BD4+
5 BD4-	White/Blue	5 BD4-
6 RX-	Green	6 RX-
7 BD3+	White/Brown	7 BD3+
8 BD3-	Brown	8 BD3-



Driver Version:

Version	Date	Description
V1.21	Jan/06/2011	

MITSUBISHI Q00/Q00UJ/Q01/QJ71

Supported series: Mitsubishi Q series PLC with QJ71C24 communication module, Q00, Q00J, Q00UJ, Q01, Q02H, Q06H, Q12H, Q25H, Q12PH, Q25PH CPU port.

Website: <http://www.mitsubishi-automation.com>

HMI Setting:

Parameters	Recommend	Option	Notes
PLC type	MITSUBISHI Q00/Q00UJ/Q01/QJ71		
PLC I/F	RS232	RS485 4W, RS232	
Baud rate	9600	9600~115200	
Parity	Odd		
Data bits	8		
Stop bits	1		
PLC st. no.	0		

Online Simulator	YES
Extend address mode	NO

PLC Setting:

Q00, Q01 CPU port setting:

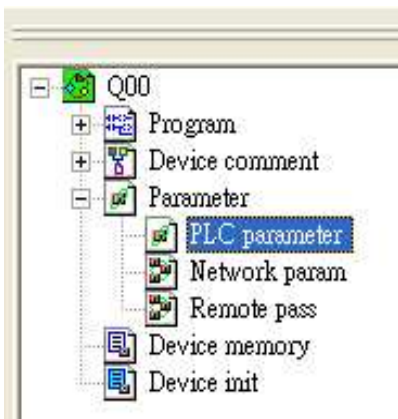

1. In the GX Developer "PLC data list" click the "PLC parameter"
2. In the "PLC parameter" select "Serial" page.
3. Select "Use serial communication"
4. Set the "Transmission speed". 9600~115200.
5. Select "Sum check"
6. Select "Transmission wait time" to 10ms.
7. Select "RUN write setting"
8. Click "End" close the dialog.
9. Write the PLC Parameter to PLC.
10. RESET the PLC, the parameter will active.

Note: Please check "Permit" in "RUN write setting" item.

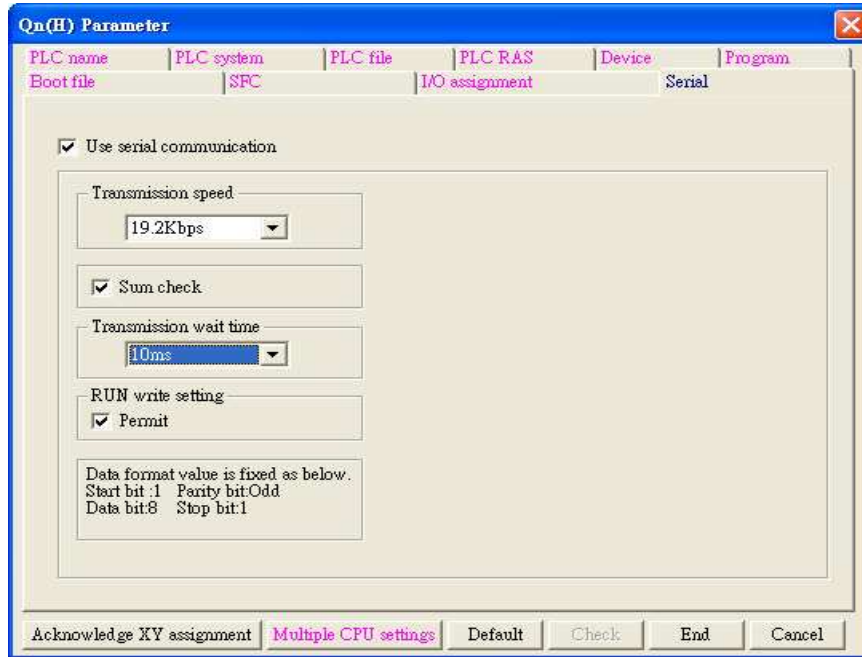

QJ71 setting:

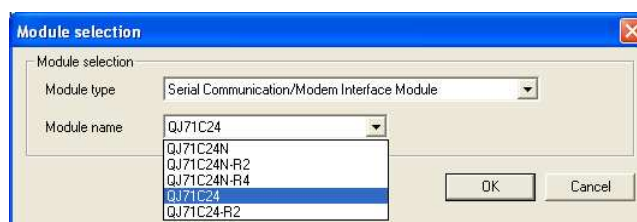
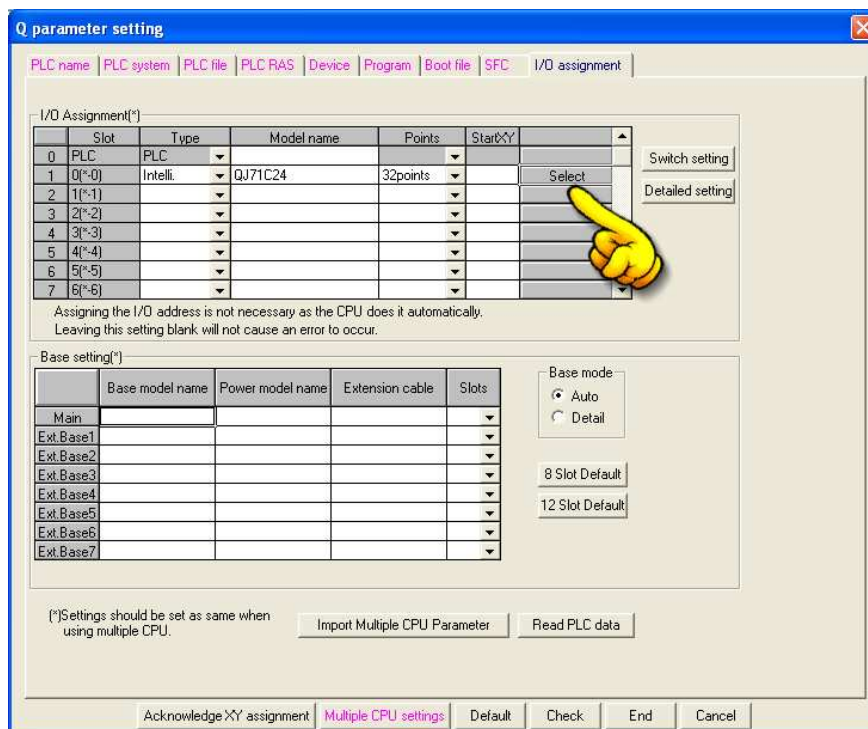

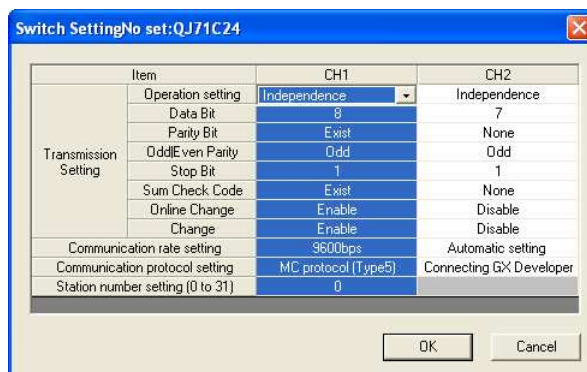

Device Address:

Bit/Word	Device type	Format	Range	Memo
B	X	HHHH	0 ~ 1fff	Input Relay
B	Y	HHHH	0 ~ 1fff	Output Relay
B	M	DDDD	0 ~ 8191	Internal Relay
B	L	DDDD	0 ~ 8191	Latch Relay
B	F	DDDD	0 ~ 2047	Annunciator
B	V	DDDD	0 ~ 2047	Edge Relay
B	B	HHHH	0 ~ 1fff	Link Relay
B	TC	DDDD	0 ~ 2047	Timer Coil
B	SS	DDDD	0 ~ 2047	Retentive Timer Contact
B	SC	DDDD	0 ~ 2047	Retentive Timer Coil
B	CS	DDDD	0 ~ 1023	Counter Contact
B	CC	DDDD	0 ~ 1023	Counter Coil
B	SB	HHH	0 ~ 7ff	Special Link Relay
B	S	DDDD	0 ~ 8191	Step Relay
B	DX	HHHH	0 ~ 1fff	Direct Input
B	DY	HHHH	0 ~ 1fff	Direct Output
B	TS	DDDD	0 ~ 2047	Timer Contact
W	W	HHHH	0 ~ 2fff	Link Register
W	TN	DDDD	0 ~ 2047	Timer Current Value
W	SN	DDDD	0 ~ 2047	Retentive Timer Current Value
W	CN	DDDD	0 ~ 1023	Counter Current Value
W	R	DDDDD	0 ~ 32767	File Register
W	SW	HHH	0 ~ 7ff	Special Link Register
W	Z	DD	0 ~ 15	Index Register
W	ZR	HHHH	0 ~ ffff	File Register

Bit/Word	Device type	Format	Range	Memo
W	D	DDDDD	0 ~ 12287	Data Register

Wiring Diagram:

HMI COM1 RS485 4W 9P D-Sub Female			QJ71C24 CH.2 RS422
1 RX-			SDB
2 RX+			SDA
3 TX-			RDB
4 TX+			RDA
5 GND			GND

9P D-Sub to 9P D-Sub:

HMI COM1 RS232 9P D-Sub Male	HMI COM2 RS232 9P D-Sub Male	HMI COM3 RS232 9P D-Sub Female	QJ71C24 CH.1 RS232 9P D-Sub
2 RX	6 RX	8 RX	3 TXD
3 TX	4 TX	7 TX	2 RXD
5 GND	5 GND	5 GND	5 GND
			1 DCD
			4 DTR
			6 DSR
			7 RTS
			8 CTS



9P D-Sub to 6P Mini-DIN: Q00, Q01 CPU port RS232

HMI COM1 RS232 9P D-Sub Male	HMI COM2 RS232 9P D-Sub Male	HMI COM3 RS232 9P D-Sub Female	Q00, Q01 CPU Port RS232 6P Mini-DIN	
2 RX	6 RX	8 RX	4 TXD	
3 TX	4 TX	7 TX	3 RXD	
5 GND	5 GND	5 GND	5 GND	
				

9P D-Sub to 6P Mini-DIN: Q00UJ CPU port RS232

HMI COM1 RS232 9P D-Sub Male	HMI COM2 RS232 9P D-Sub Male	HMI COM3 RS232 9P D-Sub Female	Q00UJ CPU Port RS232 6P Mini-DIN	
2 RX	6 RX	8 RX	4 TXD	
3 TX	4 TX	7 TX	3 RXD	
5 GND	5 GND	5 GND	5 GND	
			1 RTS	circuit
			6 CTS	
				

Driver Version:

Version	Date	Description
V1.46	Oct/22/2010	

mitsubishi Q00J

Supported series: MITSUBISHI Q00J CPU

HMI Setting:

Parameters	Recommend	Option	Notes
PLC type	MITSUBISHI Q00J		
PLC I/F	RS232		CPU port
Baud rate	115200	9600,19200,38400, 57600,115200	
Data bits	8		
Parity	Odd		
Stop bits	1		
PLC st. no.			

Device Address:

Bit/Word	Device type	Format	Range	Memo
B	SM	DDDD	0 ~ 1023	
B	X	HHH	0 ~ 7ff	
B	Y	HHH	0 ~ 7ff	
B	M	DDDD	0 ~ 8191	
B	L	DDDD	0 ~ 2047	
B	F	DDDD	0 ~ 1023	
B	V	DDDD	0 ~ 1023	
B	B	HHH	0 ~ 7ff	
B	SB	HHH	0 ~ 3ff	
W	SD	DDDD	0 ~ 1023	
W	W	HHH	0 ~ 7ff	
W	T	DDD	0 ~ 511	
W	SW	HHH	0 ~ 3ff	
W	Z	D	0 ~ 9	
W	C	DDD	0 ~ 511	
W	D	DDDDD	0 ~ 11135	

Wiring Diagram:

9P D-Sub to 6P Mini-DIN: Q00 CPU port RS232

HMI COM1 RS232 9P D-Sub Male	HMI COM2 RS232 9P D-Sub Male	HMI COM3 RS232 9P D-Sub Female	Q00 CPU Port RS232 6P Mini-DIN
2 RX	6 RX	8 RX	4 TXD
3 TX	4 TX	7 TX	3 RXD
5 GND	5 GND	5 GND	5 GND



MT8-Mitsubishi-Q-3M cable is able to connect MT8000 and Mitsubishi Q series directly.

Driver Version:

Version	Date	Description
V1.10	Sep/18/2009	

MITSUBISHI Q00U/Q01U/Q02U/QnUD/QnUDH

Supported series: MITSUBISHI Q00U, Q01U, Q02U, Q03UD, Q04UDH, Q06UDH, Q10UDH, Q13UDH, Q20UDH, Q26UDH CPU.

HMI Setting:

Parameters	Recommend	Option	Notes
PLC type	MITSUBISHI Q00U/Q01U/Q02U/QnUD/QnUDH		
PLC I/F	RS232	RS485 4W, RS232	CPU port connect directly
Baud rate	115200	115200 only	9600,19200,38400,57600,115200 For Q00UJ, only 9600 available
Parity	Odd		
Data bits	8		
Stop bits	1		
PLC st. no.	No		

Device Address:

Bit/Word	Device type	Format	Range	Memo
B	X	HHHH	0 ~ 1fff	Input Relay
B	Y	HHHH	0 ~ 1fff	Output Relay
B	M	DDDD	0 ~ 8191	Internal Relay
B	L	DDDD	0 ~ 8191	Latch Relay
B	F	DDDD	0 ~ 2047	Annunciator
B	V	DDDD	0 ~ 2047	Edge Relay
B	B	HHHH	0 ~ 1fff	Link Relay
B	SB	HHH	0 ~ 7ff	Special Link Relay
W	W	HHHH	0 ~ 1fff	Link Register
W	T	DDDD	0 ~ 0247	Timer Current Value
W	SW	HHH	0 ~ 7ff	Special Link Register
W	Z	DD	0 ~ 19	Index Register
W	C	DDDD	0 ~ 1023	Counter Current Value
W	D	DDDDD	0 ~ 12287	Data Register

Bit/Word	Device type	Format	Range	Memo
W	R	DDDDD	0 ~ 32767	

Note:

EasyBuilder doesn't support MITSUBISHI Q02U CPU to do on-line simulation on PC. When using Q02U driver, HMI needs 10 seconds to initial the PLC Q02U driver. Before finishing initial, we suggest users don't wire data to PLC, or it could cause the "PLC no response"; if the wiring diagram or the data are incorrect, it could cause PLC locked. If the PLC locked, users have to restart PLC or reinstall PLC module.

Wiring Diagram:

9P D-Sub to 6P Mini-DIN: Q02 CPU port RS232

HMI COM1 RS232 9P D-Sub Male	HMI COM2 RS232 9P D-Sub Male	HMI COM3 RS232 9P D-Sub Female	Q02 CPU Port RS232 6P Mini-DIN	
2 RX	6 RX	8 RX	3 TXD	
3 TX	4 TX	7 TX	4 RXD	
5 GND	5 GND	5 GND	5 GND	
			1 RTS	circuit
			6 CTS	



Driver Version:

Version	Date	Description
V1.40	Jul/08/2009	

MITSUBISHI Q00UJ/QnU/QnUD/QnUDH/QnUDEH (mini USB)

Supported series: MITSUBISHI Q00UJ, Q00U, Q01U, Q02U, Q03UDE, Q03UD, Q04UDEH, Q04UDH, Q06UDEH, Q06UDH, Q10UDEH, Q10UDH, Q13UDEH, Q13UDH, Q20UDEH, Q20UDH, Q26UDEH, Q26UDH USB Port.

HMI Setting:

Parameters	Recommend	Option	Notes
PLC type	MITSUBISHI Q00UJ/QnU/QnUD/QnUDH/QnUDEH (mini USB)		
PLC I/F	USB		CPU port connect directly
PLC st. no.			

Device Address:

Bit/Word	Device type	Format	Range	Memo
B	X	HHHH	0 ~ 1fff	Input Relay
B	Y	HHHH	0 ~ 1fff	Output Relay
B	M	DDDD	0 ~ 8191	Internal Relay
B	L	DDDD	0 ~ 8191	Latch Relay
B	F	DDDD	0 ~ 2047	Annunciator
B	V	DDDD	0 ~ 2047	Edge Relay
B	B	HHHH	0 ~ 1fff	Link Relay
B	SB	HHH	0 ~ 7ff	Special Link Relay
W	W	HHHH	0 ~ 1fff	Link Register
W	T	DDDD	0 ~ 0247	Timer Current Value
W	SW	HHH	0 ~ 7ff	Special Link Register
W	Z	DD	0 ~ 19	Index Register
W	C	DDDD	0 ~ 1023	Counter Current Value
W	D	DDDDD	0 ~ 12287	Data Register
W	R	DDDDD	0 ~ 32767	

Note:

EasyBuilder doesn't support MITSUBISHI Q02U CPU to do on-line simulation on PC. When using Q02U driver, HMI needs 10 seconds to initial the PLC Q02U driver. Before finishing initial, we suggest users don't wire data to PLC, or it could cause the "PLC no response" ; If the wiring diagram or the data are incorrect, it could causes PLC locked. If the PLC locked, users have to restart PLC or reinstall PLC module.

Driver Version:

Version	Date	Description
V1.00	May/05/2010	Driver released

MITSUBISHI Q02/02H

Supported series; Mitsubishi Q02/Q02H CPU port.

Website: <http://www.mitsubishi-automation.com>

HMI Setting:

Parameters	Recommend	Option	Notes
PLC type	MITSUBISHI Q02/02H		
PLC I/F	RS232	RS485 4W, RS232	
Baud rate	115200	115200 only	
Parity	Odd		
Data bits	8		
Stop bits	1		
PLC st. no.	0		

Online Simulator	YES	Extend address mode	NO
Broadcast command	NO		

Device Address:

Bit/Word	Device type	Format	Range	Memo
B	X	HHHH	0 ~ 1fff	Input Relay
B	Y	HHHH	0 ~ 1fff	Output Relay
B	M	DDDD	0 ~ 8191	Internal Relay
B	L	DDDD	0 ~ 8191	Latch Relay
B	F	DDDD	0 ~ 2047	Annunciator
B	V	DDDD	0 ~ 2047	Edge Relay
B	B	HHHH	0 ~ 1fff	Link Relay
B	TC	DDDD	0 ~ 2047	Timer Coil
B	SS	DDDD	0 ~ 2047	Retentive Timer Contact
B	SC	DDDD	0 ~ 2047	Retentive Timer Coil
B	CS	DDDD	0 ~ 1023	Counter Contact
B	CC	DDDD	0 ~ 1023	Counter Coil
B	SB	HHH	0 ~ 7ff	Special Link Relay
B	S	DDDD	0 ~ 8191	Step Relay
B	DX	HHHH	0 ~ 1fff	Direct Input

Bit/Word	Device type	Format	Range	Memo
B	DY	HHHH	0 ~ 1fff	Direct Output
B	TS	DDDD	0 ~ 2047	Timer Contact
W	W	HHHH	0 ~ 1fff	Link Register
W	TN	DDDD	0 ~ 2047	Timer Current Value
W	SN	DDDD	0 ~ 2047	Retentive Timer Current Value
W	CN	DDDD	0 ~ 1023	Counter Current Value
W	R	DDDDD	0 ~ 32767	File Register
W	SW	HHH	0 ~ 7ff	Special Link Register
W	Z	DD	0 ~ 15	Index Register
W	ZR	HHHH	0 ~ ffff	File Register
W	D	DDDDD	0 ~ 12287	Data Register

Wiring Diagram:

9P D-Sub to 6P Mini-DIN: Q02 CPU port RS232

HMI COM1 RS232 9P D-Sub Male	HMI COM2 RS232 9P D-Sub Male	HMI COM3 RS232 9P D-Sub Female	Q02 CPU Port RS232 6P Mini-DIN	
2 RX	6 RX	8 RX	3 TXD	
3 TX	4 TX	7 TX	4 RXD	
5 GND	5 GND	5 GND	5 GND	
			1 RTS	circuit
			6 CTS	



Driver Version:

Version	Date	Description
V1.50	Jan/05/2010	Fixed communication problem.

MITSUBISHI Q06H

Supported series: Mitsubishi Q06H CPU port.

Website: <http://www.mitsubishi-automation.com>

HMI Setting:

Parameters	Recommend	Option	Notes
PLC type	MITSUBISHI Q06H		
PLC I/F	RS232	RS485 4W, RS232	
Baud rate	115200	115200 only	
Parity	Odd		
Data bits	8		
Stop bits	1		
PLC st. no.	0		

Online Simulator	YES	Extend address mode	NO
Broadcast command	NO		

Device Address:

Bit/Word	Device type	Format	Range	Memo
B	X	HHHH	0 ~ 1fff	Input Relay
B	Y	HHHH	0 ~ 1fff	Output Relay
B	M	DDDD	0 ~ 8191	Internal Relay
B	L	DDDD	0 ~ 8191	Latch Relay
B	F	DDDD	0 ~ 2047	Annunciator
B	V	DDDD	0 ~ 2047	Edge Relay
B	B	HHHH	0 ~ 1fff	Link Relay
B	TC	DDDD	0 ~ 2047	Timer Coil
B	SS	DDDD	0 ~ 2047	Retentive Timer Contact
B	SC	DDDD	0 ~ 2047	Retentive Timer Coil
B	CS	DDDD	0 ~ 1023	Counter Contact
B	CC	DDDD	0 ~ 1023	Counter Coil
B	SB	HHH	0 ~ 7ff	Special Link Relay
B	S	DDDD	0 ~ 8191	Step Relay
B	DX	HHHH	0 ~ 1fff	Direct Input

Bit/Word	Device type	Format	Range	Memo
B	DY	HHHH	0 ~ 1fff	Direct Output
B	TS	DDDD	0 ~ 2047	Timer Contact
W	W	HHHH	0 ~ 1fff	Link Register
W	TN	DDDD	0 ~ 2047	Timer Current Value
W	SN	DDDD	0 ~ 2047	Retentive Timer Current Value
W	CN	DDDD	0 ~ 1023	Counter Current Value
W	R	DDDDD	0 ~ 32767	File Register
W	SW	HHH	0 ~ 7ff	Special Link Register
W	Z	DD	0 ~ 15	Index Register
W	ZR	HHHH	0 ~ ffff	File Register
W	D	DDDDD	0 ~ 12287	Data Register

Wiring Diagram:

9P D-Sub to 6P Mini-DIN: Q02 CPU port RS232

HMI COM1 RS232 9P D-Sub Male	HMI COM2 RS232 9P D-Sub Male	HMI COM3 RS232 9P D-Sub Female	Q02 CPU Port RS232 6P Mini-DIN	
2 RX	6 RX	8 RX	4 TXD	
3 TX	4 TX	7 TX	3 RXD	
5 GND	5 GND	5 GND	5 GND	
			1 RTS	circuit
			6 CTS	



Driver Version:

Version	Date	Description
V1.50	Jan/06/2010	

MITSUBISHI QJ71E71 (Ethernet)

Supported series ; Mitsubishi Q type, MELSEC-Q series PLC (Q00J, Q00, Q01, Q02, Q02H, Q06H, Q12H, Q25H, Q12PH, Q25PH) QJ71E71-100 Ethernet module.

Website: <http://www.mitsubishi-automation.com>

HMI Setting:

Parameters	Recommend	Option	Notes
PLC type	MITSUBISHI QJ71E71 (Ethernet)		
PLC I/F	Ethernet		
PLC st. no.	2	1~99	
Port no.	5002		

Note: MITSUBISHI QJ71E71 only supports PLC Network no. 1.

If PLC's Network no. is not 1, please use "MITSUBISHI MELSEC-Q(Ethernet)" driver and fill in the Network no. in Parameter 1. Please refer MITSUBISHI MELSEC-Q(Ethernet) for further information.

PLC Setting:

QJ71E71-100 Ethernet module settings:

1. Use Q-CPU's USB or RS232 setting PLC parameters.

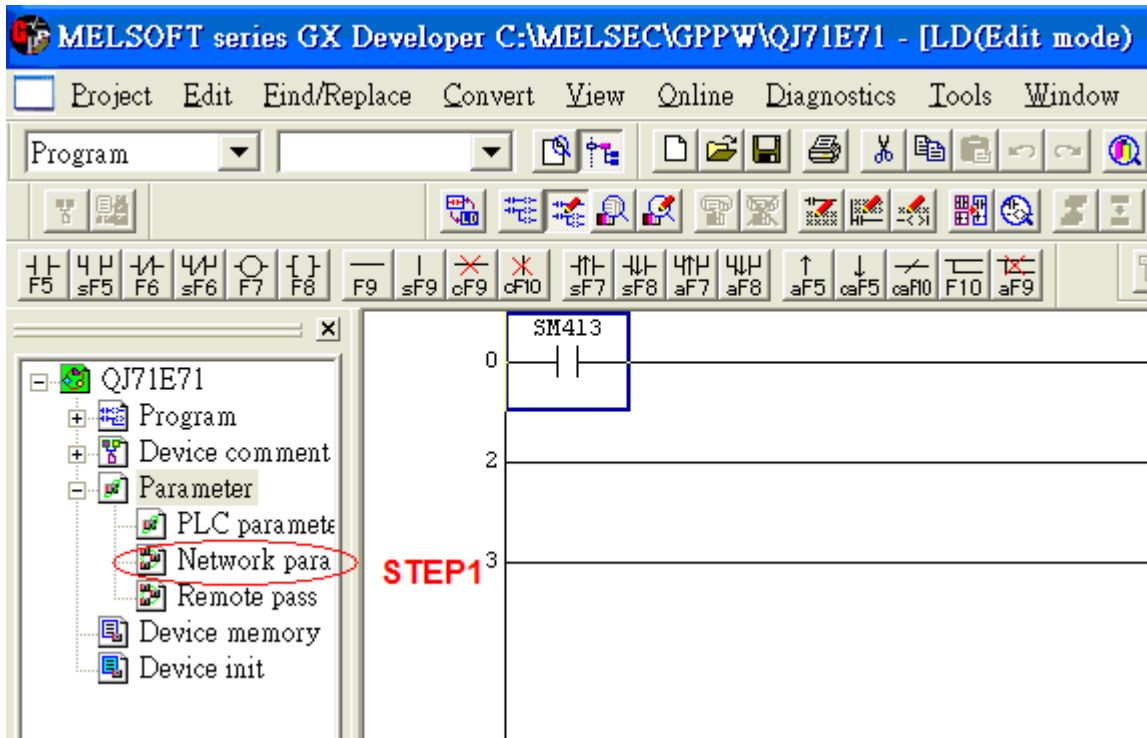

2. Click Operational setting to set IP information.

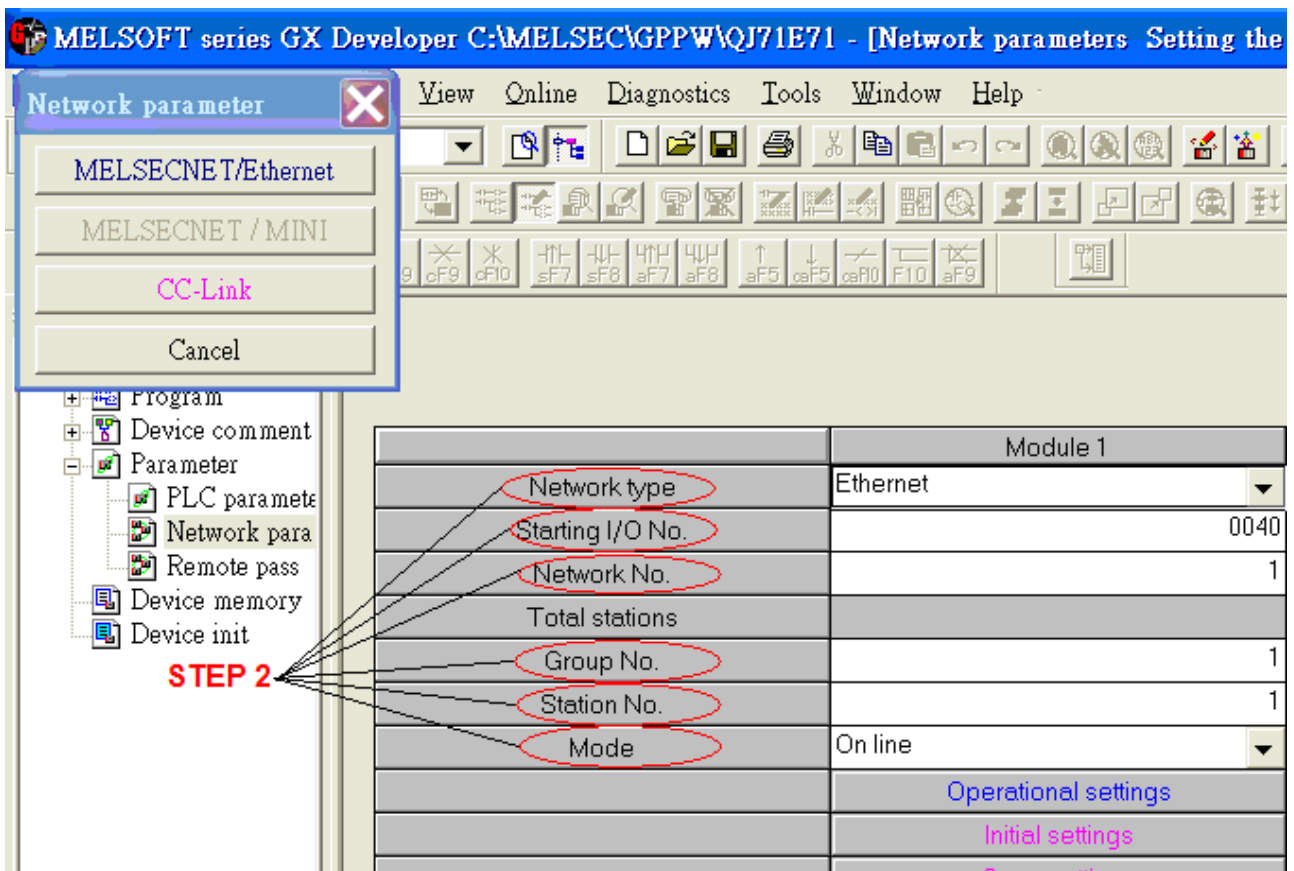

	Module 1	Module 2
Network type	Ethernet	None
Starting I/O No.	0040	
Network No.	1	
Total stations		
Group No.	1	
Station No.	1	
Mode	On line	
	Operational settings	
	Initial settings	
	Open settings	
	Router relay parameter	
	Station No. <-> IP information	
	FTP Parameters	
	E-mail settings	
	Interrupt settings	

- Select Ethernet (2.0) for communicating with HMI.

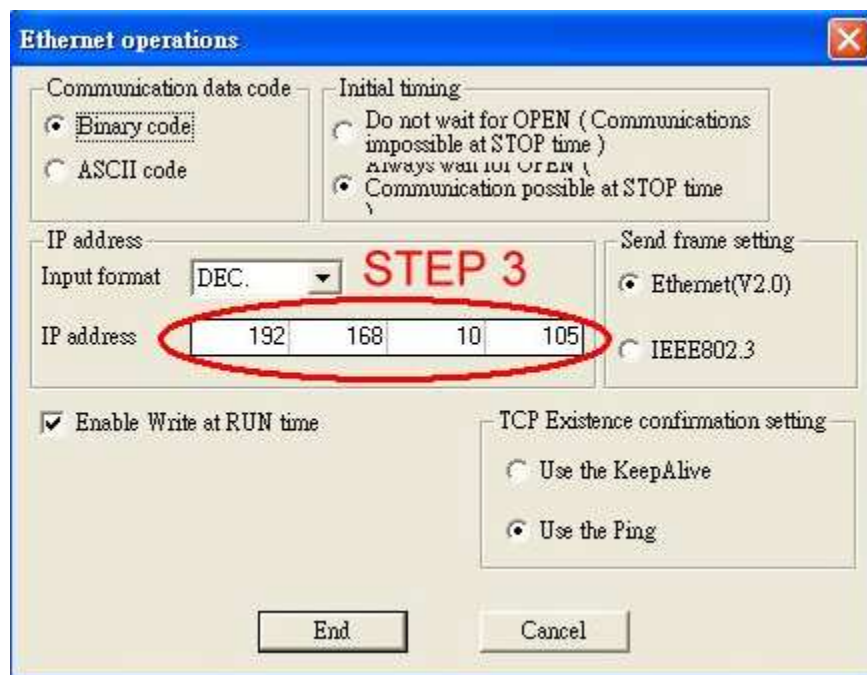

- Click "Open settings" to set the system.

	Module 1	Module 2
Network type	Ethernet	None
Starting I/O No.	0040	
Network No.	1	
Total stations		
Group No.	1	
Station No.	1	
Mode	On line	
	Operational settings	
	Initial settings	
	STEP 4 Open settings	
	Router relay parameter	
	Station No. <-> IP information	
	FTP Parameters	
	E-mail settings	
	Interrupt settings	

Network parameter Ethernet open setting. Module No. 1

	Protocol	Open system	Fixed buffer	Fixed buffer communication procedure	Pairing open	Existence confirmation	Host station Port No.	Transmission target device IP address	Transmission target device Port No.
1	TCP	MELSOFT connection							
2	TCP	MELSOFT connection							
3	TCP	MELSOFT connection							
4	TCP	MELSOFT connection							
5									
6									
7									
8									
9									
10									
11									
12									
13									
14									
15									
16									

End Cancel

5. Press END to finish settings.

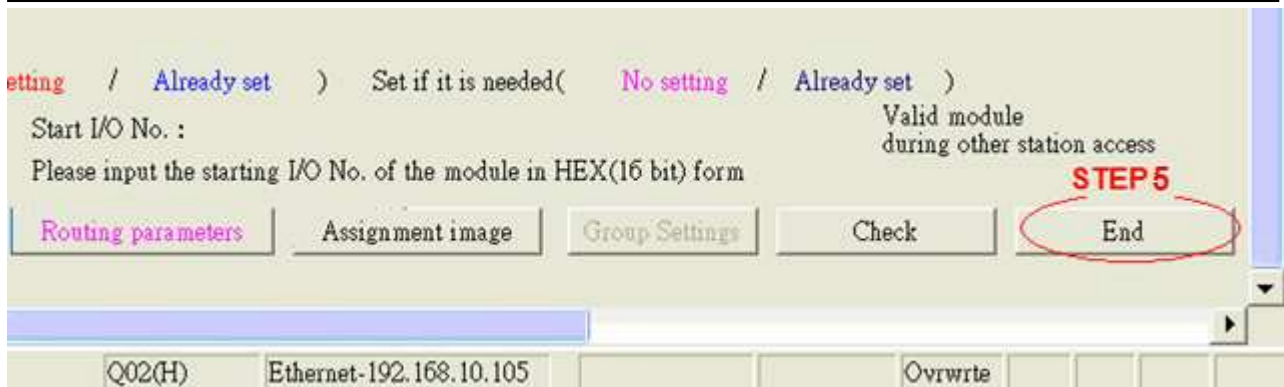

- Restart PLC software and select [READ FROM PLC], click QCPU(Qmode) and press OK.

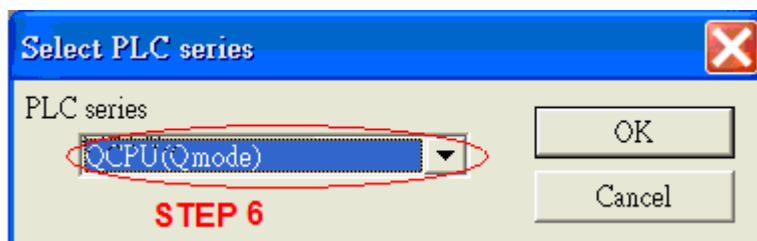

- Select "Ethernet board" in PC Side I/F to set Network and Station no. (the Station no.1 is PC's station no. not Ethernet module's, range from 2~64, the Network no. can not the same as PC's number)

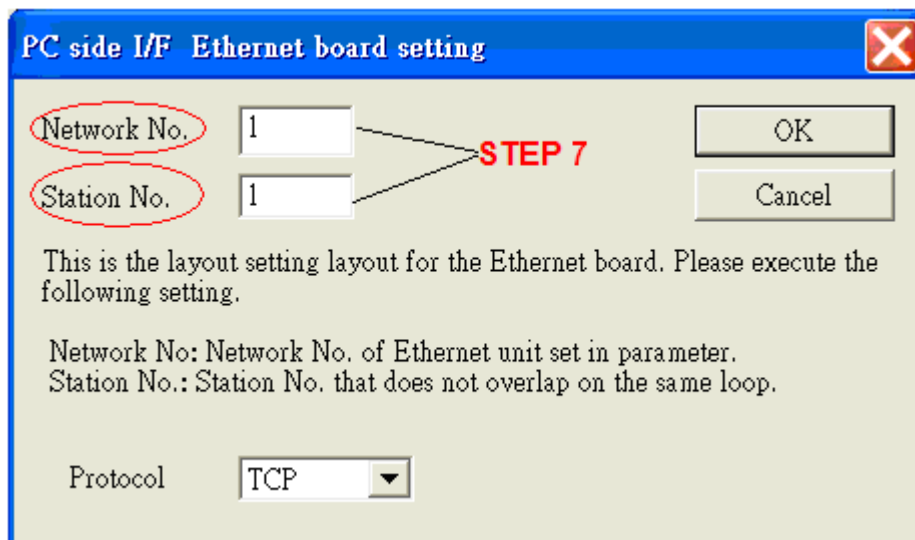

- Select "Ethernet module" in PLC Side I/F to set QJ71E71's IP address.(IP address = Network Parameter's IP address)

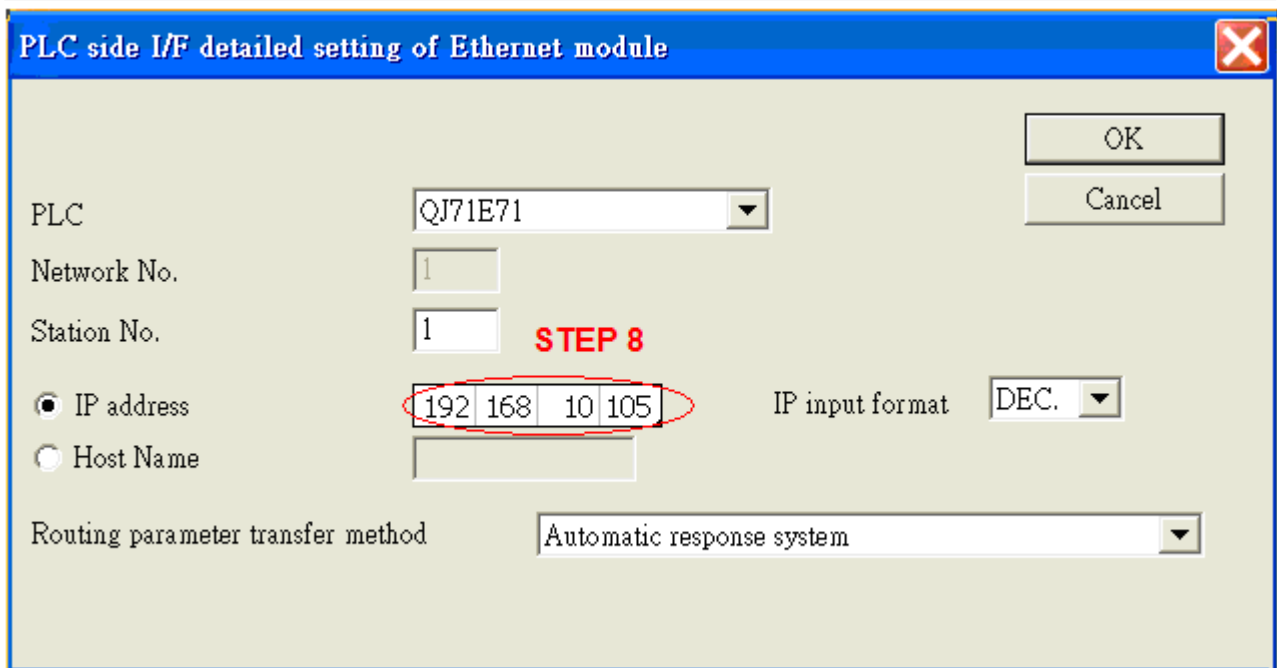

- In "Other station", click "Other station(Single network)" setting "Check at communication time" and "Retry times".

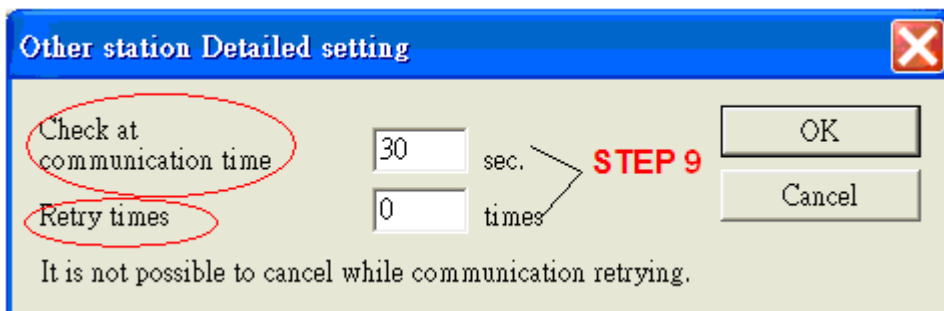

After finishing settings as above, click "Connection test" for testing the communication and sending the PLC's program.

Device Address:

Bit/Word	Device type	Format	Range	Memo
B	SM	DDDD	0 ~ 2047	
B	X	HHHH	0 ~ 1fff	Input Relay
B	Y	HHHH	0 ~ 1fff	Output Relay
B	M	DDDD	0 ~ 8191	Internal Relay
B	L	DDDD	0 ~ 8191	Latch Relay
B	F	DDDD	0 ~ 2047	Annunciator
B	V	DDDD	0 ~ 2047	Edge Relay

Bit/Word	Device type	Format	Range	Memo
B	B	HHHH	0 ~ 1fff	Link Relay
B	TS	DDDD	0 ~ 2047	
B	TC	DDDD	0 ~ 2047	
B	SS	DDDD	0 ~ 2047	
B	SC	DDDD	0 ~ 2047	
B	CS	DDDD	0 ~ 1023	
B	CC	DDDD	0 ~ 1023	
B	SB	HHH	0 ~ 7ff	Special Link Relay
B	S	DDDD	0 ~ 8191	
B	DX	HHHH	0 ~ 1fff	Direct Input
B	DY	HHHH	0 ~ 1fff	Direct Output
W	SD	DDDD	0 ~ 2047	
W	W	HHHH	0 ~ 1fff	Link Register
W	R	DDDDD	0 ~ 32767	File Register
W	SW	HHH	0 ~ 7ff	Special Link Register
W	Z	DD	0 ~ 15	Index Register
W	ZR	HHHHH	0 ~ fe7ff	File Register
W	D	DDDDD	0 ~ 12287	Data Register
W	TN	DDDD	0 ~ 2047	
W	SN	DDDD	0 ~ 2047	
W	CN	DDDD	0 ~ 1023	

Wiring Diagram:

Direct connect (crossover cable):

HMI RJ45 Female	Wire Color	PLC RJ45 Female
1 TX+	White/Orange	3 RX+
2 TX-	Orange	6 RX-
3 RX+	White/Green	1 TX+
4 BD4+	Blue	4 BD4+
5 BD4-	White/Blue	5 BD4-
6 RX-	Green	2 TX-
7 BD3+	White/Brown	7 BD3+
8 BD3-	Brown	8 BD3-



Through a hub:

HMI RJ45 Female	Wire Color	PLC RJ45 Female
1 TX+	White/Orange	1 TX+
2 TX-	Orange	2 TX-
3 RX+	White/Green	3 RX+
4 BD4+	Blue	4 BD4+
5 BD4-	White/Blue	5 BD4-
6 RX-	Green	6 RX-
7 BD3+	White/Brown	7 BD3+
8 BD3-	Brown	8 BD3-



Driver Version:

Version	Date	Description
V2.10	Feb/05/2009	

MODBUS ASCII

Supported series: MODBUS ASCII CONTROLLER

Website: <http://www.modbus.org>

HMI Setting:

Parameters	Recommend	Option	Notes
PLC type	MODBUS ASCII		
PLC I/F	RS485	RS232/RS485	
Baud rate	9600	9600/19200/38400/ 57600/115200	
Parity	Even	Even, Odd, None	
Data bits	8	7,8	
Stop bits	1	1,2	
PLC st. no.	1	0-255	

Online Simulator	YES	Broadcast command	YES
Extend address mode	YES		

PLC Setting:

Communication mode	Modbus ASCII protocol
--------------------	-----------------------

Device Address:

Bit/Word	Device type	Format	Range	Memo
B	0x	DDDDD	1 ~ 65535	Output bit
B	1x	DDDDD	1 ~ 65535	Input bit (read only)
B	3x_Bit	DDDDDdd	100 ~ 6553515	Input Register bit (read only)
B	4x_Bit	DDDDDdd	100 ~ 6553515	Output Register bit
W	3x	DDDDD	1 ~ 65535	Input Register (read only)
W	4x	DDDDD	1 ~ 65535	Output Register
W	6x	DDDDD	1 ~ 65535	

Modbus RTU function code:

0x	0x01 Read coil	0x05 write single coil
1x	0x02 Read discrete input	N/A for write operation
3x	0x04 Read input register	N/A for write operation
4x	0x03 Read holding register	0x10 write multiple register

3xbit is equivalent to 3x
4xbit is equivalent to 4x

Wiring Diagram:

9P D-Sub to 9P D-Sub:

HMI COM1 RS232 9P D-Sub Male	HMI COM2 RS232 9P D-Sub Male	HMI COM3 RS232 9P D-Sub Female	Modbus ASCII Controller RS232 9P D-Sub	
2 RX	6 RX	8 RX	TXD	
3 TX	4 TX	7 TX	RXD	
5 GND	5 GND	5 GND	GND	
			RTS	circuit
			CTS	



9P D-Sub to 9P D-Sub:

HMI COM1 RS485 4W 9P D-Sub Female			Modbus ASCII Controller RS422 9P D-Sub	
1 RX-			TX-	
2 RX+			TX+	
3 TX-			RX-	
4 TX+			RX+	
5 GND			GND	



9P D-Sub to 9P D-Sub:

HMI COM1 RS485 2W 9P D-Sub Female	HMI COM3 RS485 2W 9P D-Sub Female		Modbus ASCII Controller RS485 9P D-Sub
1 RX-	6 Data-		D-
2 RX+	9 Data+		D+
5 GND	5 GND		GND
			

Driver Version:

Version	Date	Description
V1.40	Apr/17/2009	

MODBUS RTU

Supported series : MODBUS RTU CONTROLLER

Website : <http://www.modbus.org>

HMI Setting:

Parameters	Recommend	Option	Notes
PLC type	MODBUS RTU		
PLC I/F	RS485	RS232/RS485	
Baud rate	9600	9600~115200	
Parity	Even	Even, Odd, None	
Data bits	8	7, 8	
Stop bits	1	1, 2	
PLC st. no.	1	0-255	

Online Simulator	YES	Broadcast command	YES
Extend address mode	YES		

PLC Setting:

Communication mode	Modbus RTU protocol
--------------------	---------------------

Device Address:

Bit/Word	Device type	Format	Range	Memo
B	0x	DDDDD	1 ~ 65535	Output bit
B	0x_multi_coils	DDDDD	1 ~ 65535	Write Multiple Coils
B	1x	DDDDD	1 ~ 65535	Input bit (read only)
B	3x_Bit	DDDDDdd	1 ~ 6553515	Input Register bit (read only)
B	4x_Bit	DDDDDdd	1 ~ 6553515	Output Register bit
B	6x_Bit	DDDDDdd	1 ~ 6553515	Output Register bit
W	3x	DDDDD	1 ~ 65535	Input Register (read only)
W	4x	DDDDD	1 ~ 65535	Output Register
DW	5x	DDDDD	1 ~ 65535	4x double word swap
W	6x	DDDDD	1 ~ 65535	4x single word write
W	4x 32Bit	DDDDD	1 ~ 65535	4x High/low byte swap

NOTE:

Address type “5x” are mapping to Hold Reg. The communication protocol of 5x is almost same as “4x” except “5x” making double word swap.

If 4x has following information

Address	1	2	3	4	5	6	...
Data in word	0x1	0x2	0x3	0x4	0x5	0x6	
Data	0x20001		0x40003		0x60005		

For 5x, it become

Address	1	2	3	4	5	6	...
Data in word	0x2	0x1	0x4	0x3	0x6	0x5	
Data	0x10002		0x30004		0x50006		

Modbus RTU function code:

0x	0x01	Read coil	0x05	write single coil
0x_multi_coils	0x01	Read coil	0x0f	write multiple coil
1x	0x02	Read discrete input		N/A for write operation
3x	0x04	Read input register		N/A for write operation
4x	0x03	Read holding register	0x10	write multiple register
5x	0x03	Read holding register	0x10	write multiple register

(note: reverse word order in double word format)

3xbit is equivalent to 3x

4xbit is equivalent to 4x

6x	0x03	Read holding register	0x06	write single register
----	------	-----------------------	------	-----------------------

(note: use 6x device is limited to device of one word only)

Wiring Diagram:

9P D-Sub to 9P D-Sub:

HMI COM1 RS232 9P D-Sub Male	HMI COM2 RS232 9P D-Sub Male	HMI COM3 RS232 9P D-Sub Female	Modbus RTU Controller RS232 9P D-Sub	
2 RX	6 RX	8 RX	TXD	
3 TX	4 TX	7 TX	RXD	
5 GND	5 GND	5 GND	GND	
			RTS	circuit
			CTS	
				

9P D-Sub to 9P D-Sub:

HMI COM1 RS485 4W 9P D-Sub Female			Modbus RTU Controller RS422 9P D-Sub	
1 RX-			TX-	
2 RX+			TX+	
3 TX-			RX-	
4 TX+			RX+	
5 GND			GND	
				

9P D-Sub to 9P D-Sub:

HMI COM1 RS485 2W 9P D-Sub Female	HMI COM3 RS485 2W 9P D-Sub Female		Modbus RTU Controller RS485 9P D-Sub	
1 RX-	6 Data-		D-	
2 RX+	9 Data+		D+	
5 GND	5 GND		GND	

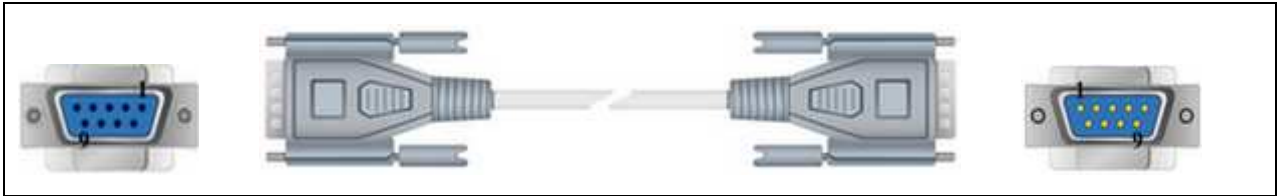

Driver Version:

Version	Date	Description
V1.90	May/05/2010	Fixed when receiving data from modbus rtu over 8 bytes, LW-9570 can not calculate correctly.

MODBUS RTU (0x/1x Range Adjustable)

Supported series : MODBUS RTU CONTROLLER

Website : <http://www.modbus.org>

HMI Setting:

Parameters	Recommend	Options	Notes
PLC type	MODBUS RTU (0x/1x Range Adjustable)		
PLC I/F	RS485	RS232/RS485	
Baud Rate	9600	9600/19200/38400/57600/115200	
Parity	Even	Even, Odd, None	
Data bits	8	7,8	
Stop bits	1	1,2	
PLC st. no.	1	0-255	

Online Simulator	YES
Extend Address Mode	YES

PLC Setting:

Communication Mode	Modbus RTU protocol
--------------------	---------------------

Device Address:

Bit/Word	Device type	Format	Range	Memo
B	0x	DDDDD	1 ~ 65535	Output bit
B	0x_multi_coils	DDDDD	1 ~ 65535	Write Multiple Coils
B	1x	DDDDD	1 ~ 65535	Input bit (read only)
B	3x_Bit	DDDDDdd	1 ~ 6553515	Input Register bit (read only)
B	4x_Bit	DDDDDdd	1 ~ 6553515	Output Register bit
B	6x_Bit	DDDDDdd	1 ~ 6553515	Output Register bit
W	3x	DDDDD	1 ~ 65535	Input Register (read only)
W	4x	DDDDD	1 ~ 65535	Output Register
DW	5x	DDDDD	1 ~ 65535	4x double word swap

W	6x	DDDDD	1 ~ 65535	4x single word write
W	4x_32Bit	DDDDD	1 ~ 65535	4x High/low byte swap

NOTE:

Address type “5x” is mapping to Hold Reg. The communication protocol of “5x” is almost same as “4x” except that “5x” makes double words swap.

If 4x contains the following information:

Address	1	2	3	4	5	6	...
Data in word	0x1	0x2	0x3	0x4	0x5	0x6	
Data	0x20001		0x40003		0x60005		

For 5x, it becomes:

Address	1	2	3	4	5	6	...
Data in word	0x2	0x1	0x4	0x3	0x6	0x5	
Data	0x10002		0x30004		0x50006		

Modbus RTU function code:

0x	0x01	Read coil	0x05	Write single coil
0x_multi_coils	0x01	Read coil	0x0f	Write multiple coil
1x	0x02	Read discrete input		N/A for writing operation
3x	0x04	Read input register		N/A for writing operation
4x	0x03	Read holding register	0x10	Write multiple register
5x	0x03	Read holding register	0x10	Write multiple register

(Note: reverse word order in double words format)

3xbit is equivalent to 3x

4xbit is equivalent to 4x

6x 0x03 Read holding register 0x06 write single register

(Note: using 6x device is limited to device of one word only)

Setting Illustrations:

- Go to [System Parameter Settings]  , click [New] to add a new device -Modbus

RTU (0x 1x range adjustable) , as shown below:

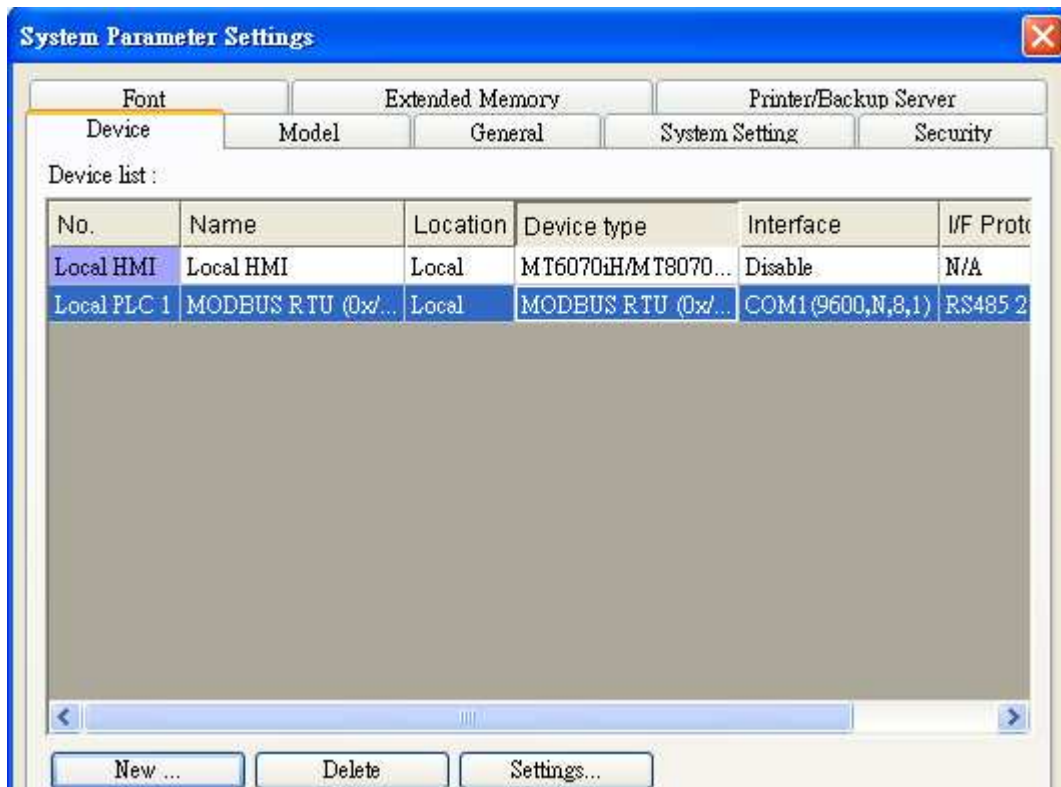

2. After adding Modbus RTU (0x 1x Range Adjustable) driver, [Add Address Range Limit] button will be enabled as below. Users can set maximum read/write command size here.

- Max.read-command size (words): Pull down to select PLC reading range.

Max. read-command size (words) :

- Max.write-command size (words): Pull down to select PLC writing range.

Max. write-command size (words) :

Note: Setting [Add Address Range Limit] is enabled only when bit address is not a multiple of 16bit.

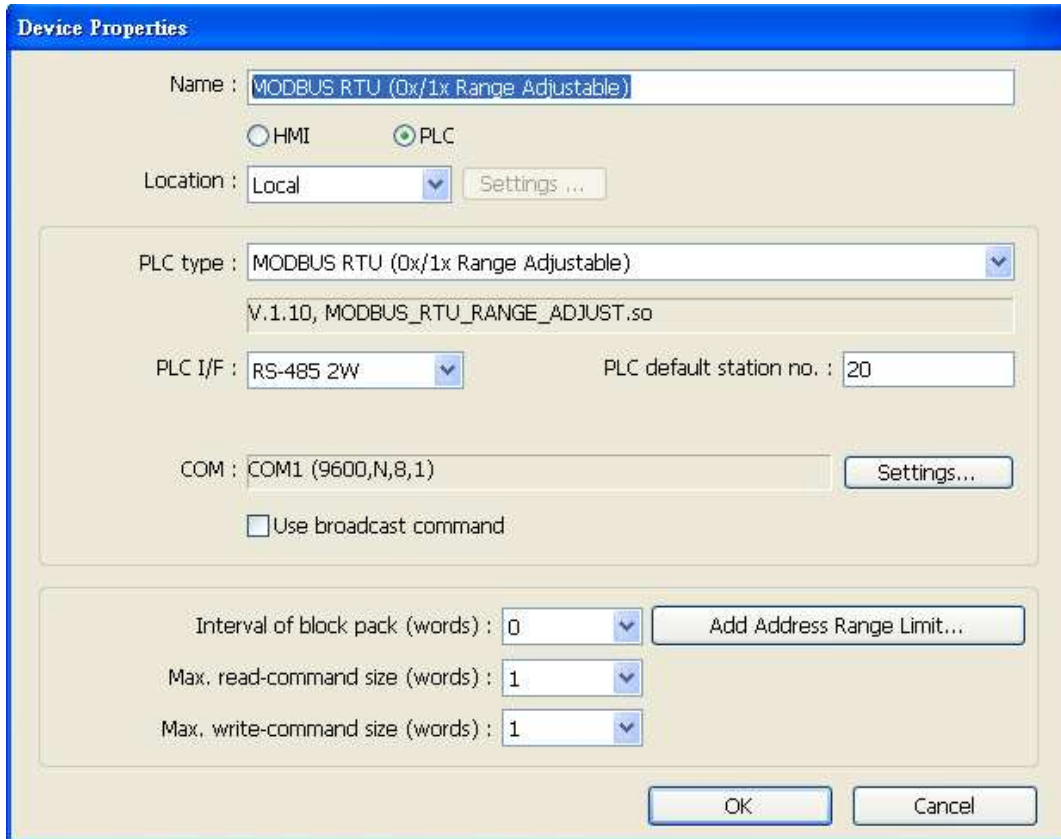

3. Click [Add Address Range Limit] button, Users can define 0x and 1x address range in [0x 1x Address Range] dialogue box, referring to bit range of the device used.

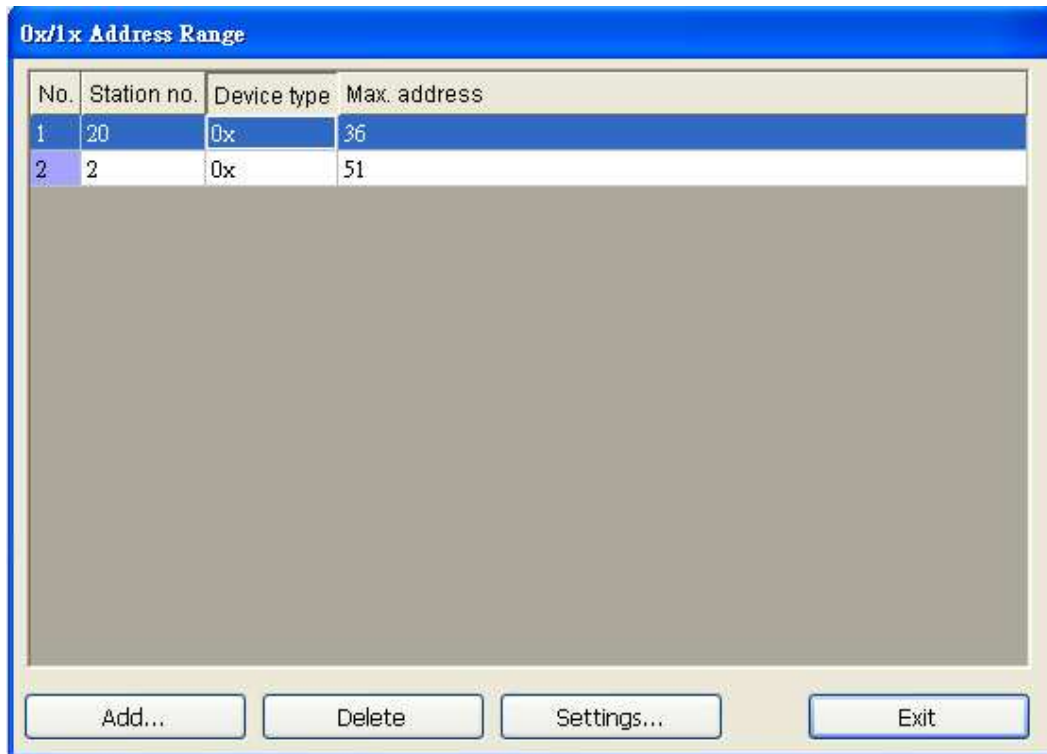

Add : Set [Station No.], [Device Type], [Max. Address] then click [OK] to finish adding as below:



Delete : The selected items will be deleted.

Settings : Set [Station No.], [Device Type], [Max. Address] then click [OK] to finish adding as below:



Example :

Take D2 and D8 of SCON as example, the settings depend on maximum bit range of different PLC types. Set [Station No.] and address first.

For D2, set [Station No.] to **20**, [Device Type] **0x**, [Max. Address] **36**.

For D8, set [Station No.] to **2**, [Device Type] **0x**, [Max. Address] **51**.

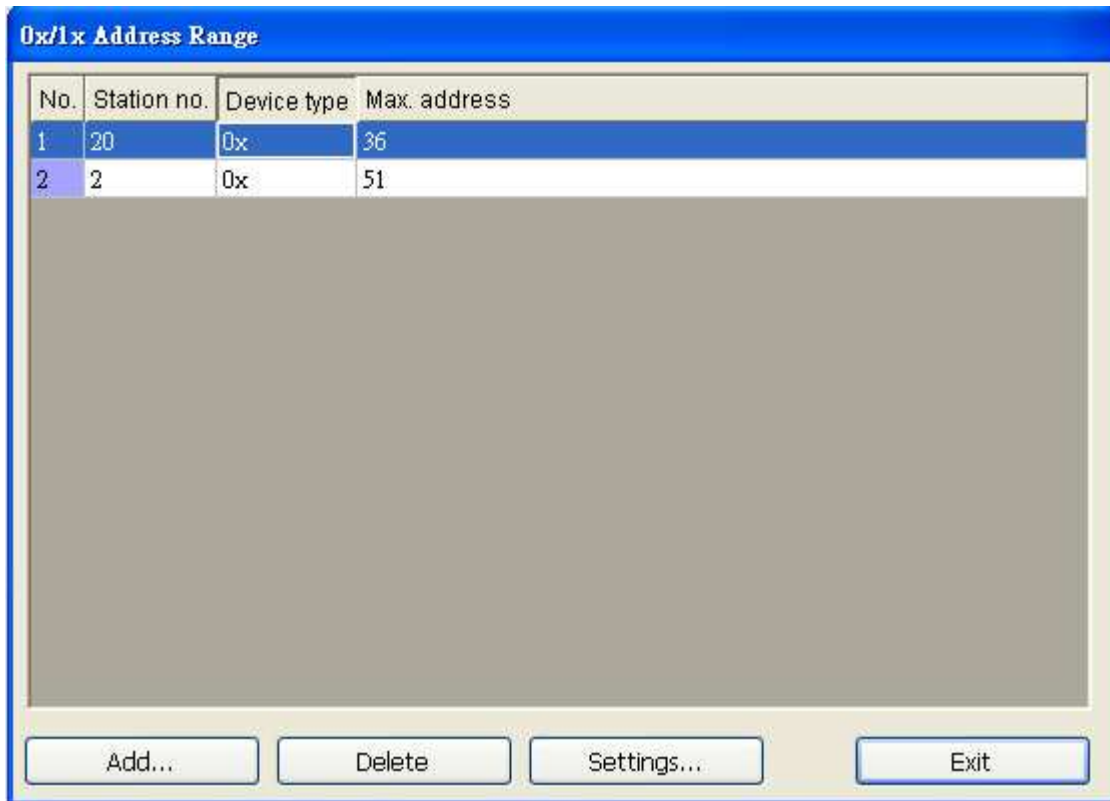

Note: If connecting with 2 or more PLC, click [Settings] in [Device Properties], and set 4 to [Turn around delay] as below.

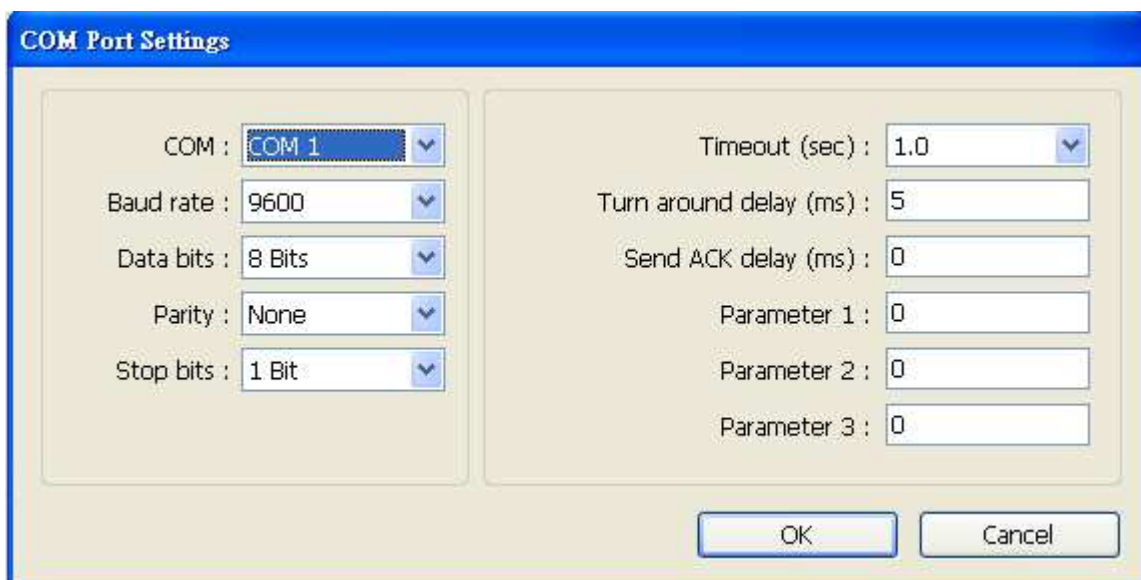

After completing all settings above, users can now communicate with the devices.

Wiring Diagram:

9P D-Sub to 9P D-Sub:

HMI COM1 RS232 9P D-Sub Male	HMI COM2 RS232 9P D-Sub Male	HMI COM3 RS232 9P D-Sub Female	Modbus RTU Controller RS232 9P D-Sub	
2 RX	6 RX	8 RX	TXD	
3 TX	4 TX	7 TX	RXD	
5 GND	5 GND	5 GND	GND	
			RTS	circuit
			CTS	



9P D-Sub to 9P D-Sub:

HMI COM1 RS485 4W 9P D-Sub Female			Modbus RTU Controller RS422 9P D-Sub	
1 RX-			TX-	
2 RX+			TX+	
3 TX-			RX-	
4 TX+			RX+	
5 GND			GND	



9P D-Sub to 9P D-Sub:

HMI COM1 RS485 2W 9P D-Sub Female	HMI COM3 RS485 2W 9P D-Sub Female		Modbus RTU Controller RS485 9P D-Sub	
1 RX-	6 Data-		D-	
2 RX+	9 Data+		D+	
5 GND	5 GND		GND	

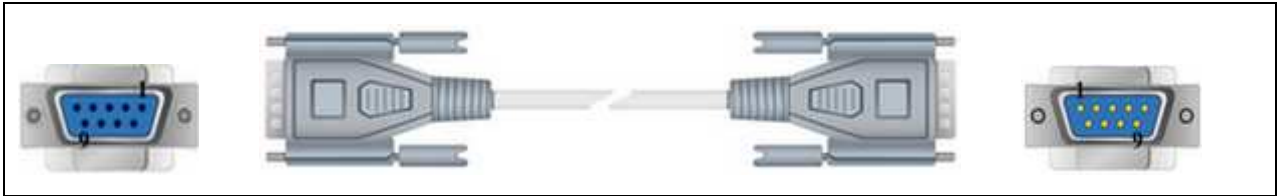

Driver Version:

Version	Date	Description
V1.10	Aug/25/2010	

MODBUS RTU (zero-based addressing)

Supported series : MODBUS RTU CONTROLLER

Website : <http://www.modbus.org>

HMI Setting:

Parameters	Recommend	Option	Notes
PLC type	MODBUS RTU (zero-based addressing)		
PLC I/F	RS485	RS232/RS485	
Baud rate	9600	9600~115200	
Parity	Even	Even, Odd, None	
Data bits	8	7,8	
Stop bits	1	1,2	
PLC st. no.	1	0-255	

Online Simulator	YES	Broadcast command	YES
Extend address mode	YES		

PLC Setting:

Communication mode	Modbus RTU protocol
--------------------	---------------------

Device Address:

Bit/Word	Device type	Format	Range	Memo
B	0x	DDDDD	0 ~ 65535	Output bit
B	1x	DDDDD	0 ~ 65535	Input bit (read only)
B	0x_multi_coils	DDDDD	0 ~ 65535	Write Multiple Coils
B	3x_Bit	DDDDDdd	0 ~ 6553515	Input Register bit (read only)
B	4x_Bit	DDDDDdd	0 ~ 6553515	Output Register bit
W	3x	DDDDD	0 ~ 65535	Input Register (read only)
W	4x	DDDDD	0 ~ 65535	Output Register
DW	5x	DDDDD	0 ~ 65535	4x double word swap
W	6x	DDDDD	0 ~ 65535	4x single word write

NOTE:

Address type “5x” are mapping to Hold Reg. The communication protocol of 5x almost same as “4x” except “5x”making double word swap.

If 4x have following information

Address	1	2	3	4	5	6	...
Data in word	0x1	0x2	0x3	0x4	0x5	0x6	
Data	0x20001		0x40003		0x60005		

For 5x, it become

Address	1	2	3	4	5	6	...
Data in word	0x2	0x1	0x4	0x3	0x6	0x5	
Data	0x10002		0x30004		0x50006		

Modbus RTU function code:

0x	0x01	Read coil	0x05	write single coil
0x_multi_coils	0x01	Read coil	0x0f	write multiple coil
1x	0x02	Read discrete input	N/A for write operation	
3x	0x04	Read input register	N/A for write operation	
4x	0x03	Read holding register	0x10	write multiple register
5x	0x03	Read holding register	0x10	write multiple register

(Note: reverse word order in double word format)

3xbit is equivalent to 3x

4xbit is equivalent to 4x

6x	0x03	Read holding register	0x06	write single register
----	------	-----------------------	------	-----------------------

(Note: use 6x device is limited to device of one word only)

Wiring Diagram:

9P D-Sub to 9P D-Sub:

HMI COM1 RS232 9P D-Sub Male	HMI COM2 RS232 9P D-Sub Male	HMI COM3 RS232 9P D-Sub Female	Modbus RTU Controller RS232 9P D-Sub	
2 RX	6 RX	8 RX	TXD	
3 TX	4 TX	7 TX	RXD	
5 GND	5 GND	5 GND	GND	
			RTS	circuit
			CTS	
				

9P D-Sub to 9P D-Sub:

HMI COM1 RS485 4W 9P D-Sub Female			Modbus RTU Controller RS422 9P D-Sub	
1 RX-			TX-	
2 RX+			TX+	
3 TX-			RX-	
4 TX+			RX+	
5 GND			GND	
				

9P D-Sub to 9P D-Sub:

HMI COM1 RS485 2W 9P D-Sub Female	HMI COM3 RS485 2W 9P D-Sub Female		Modbus RTU Controller RS485 9P D-Sub	
1 RX-	6 Data-		D-	
2 RX+	9 Data+		D+	
5 GND	5 GND		GND	

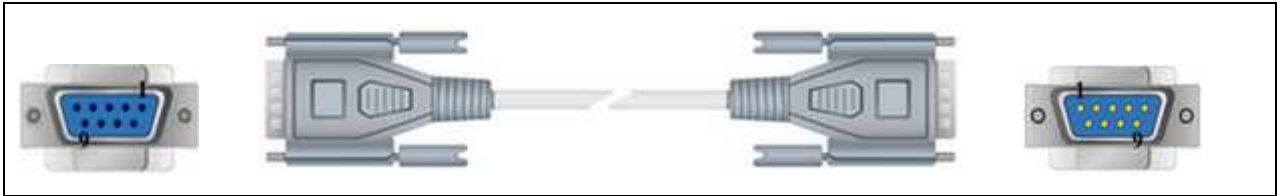

Note: MODBUS RTU (adjustable) usage

Users can decide the address range via setting value on Parameter 1. For example, when users set 5 to Parameter 1, the address range become 5 ~ 65535.

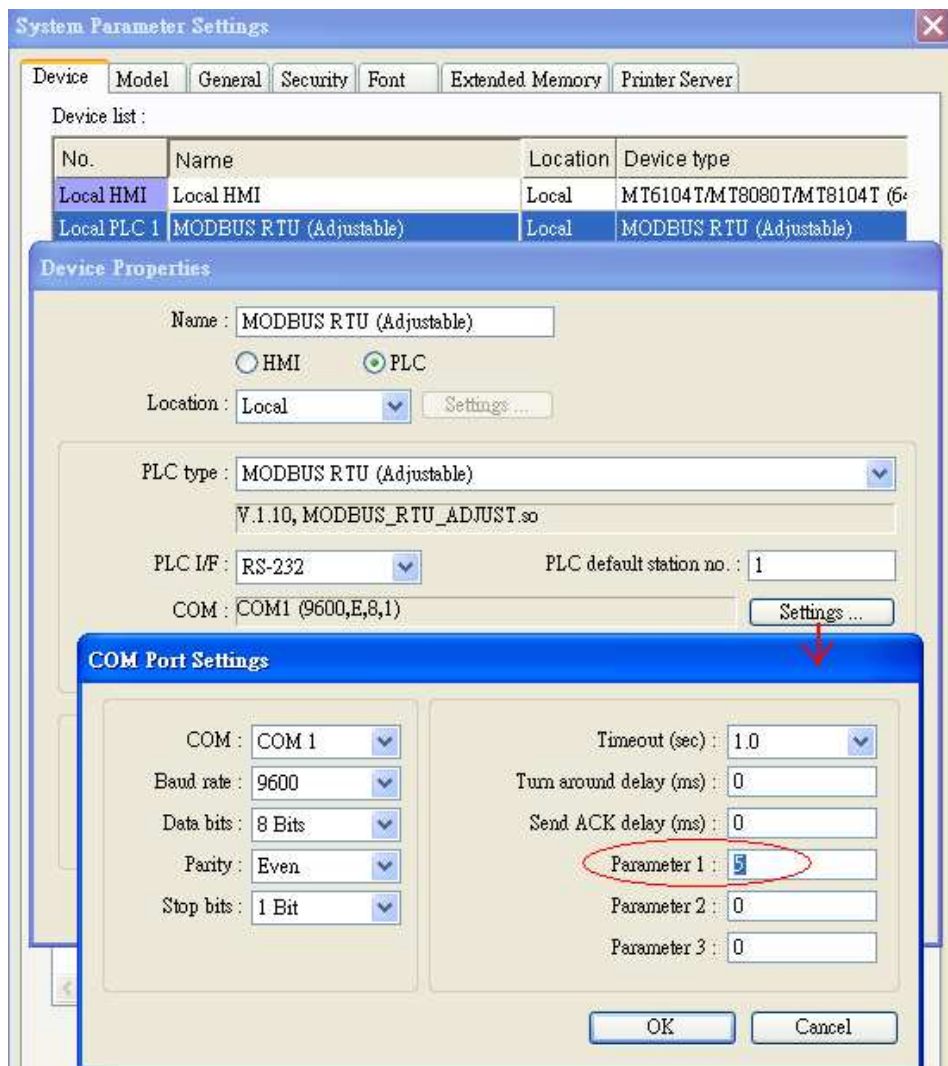

Driver Version:

Version	Date	Description
V1.30	Aug/26/2009	

MODBUS Server (Modbus RTU Slave)

HMI Setting:

Parameters	Recommend	Option	Notes
PLC type	MODBUS Server		
PLC I/F	RS232	RS232, RS485	
Baud rate	9600	9600~115200	
Parity	Even	Even, Odd, None	
Data bits	8	8	
Stop bits	1	1	
PLC st. no.	1	1-31	HMI Modbus station No.
Port no.		502	

Online Simulator	YES	Extend address mode	NO
Broadcast command	NO		

PLC Setting:

Communication mode	Modbus RTU protocol
--------------------	---------------------

Device Address:

Bit/Word	Device type	Format	Range	Memo
B	LB	dddd	0~9998	Mapping to 0x/1x 1~9999
W	LW	dddd	0~9998	Mapping to 3x/4x 1~9999
W	RW	dddddd	0~55536	Mapping to 3x/4x 10000~65536

LB0 = 0x0001, LB1 = 0x0002, LW0 = 3x0001, LW1 = 3x0002

Modbus RTU Server doesn't support function Code 06(to preset single register), please use function code 16(0x10, preset multiple register).

Wiring Diagram:

9P D-Sub to 9P D-Sub:

HMI COM1 RS232 9P D-Sub Male	HMI COM2 RS232 9P D-Sub Male	HMI COM3 RS232 9P D-Sub Female	Modbus RTU Controller RS232 9P D-Sub	
2 RX	6 RX	8 RX	TXD	
3 TX	4 TX	7 TX	RXD	
5 GND	5 GND	5 GND	GND	
			RTS	circuit
			CTS	
				

9P D-Sub to 9P D-Sub:

HMI COM1 RS485 4W 9P D-Sub Female			Modbus RTU Controller RS422 9P D-Sub	
1 RX-			TX-	
2 RX+			TX+	
3 TX-			RX-	
4 TX+			RX+	
5 GND			GND	
				

9P D-Sub to 9P D-Sub:

HMI COM1 RS485 2W 9P D-Sub Female	HMI COM3 RS485 2W 9P D-Sub Female		Modbus RTU Controller RS485 9P D-Sub	
1 RX-	6 Data-		D-	
2 RX+	9 Data+		D+	
5 GND	5 GND		GND	

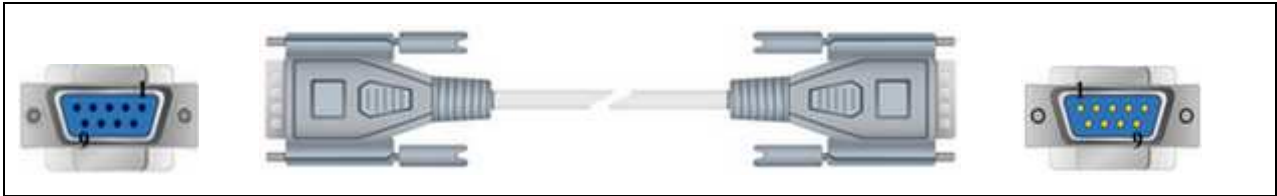

Precaution: Setting more than one Modbus server in HMI device list is useless.

Driver Version:

Version	Date	Description
V1.00	Dec/30/2008	Driver released.

MODBUS TCP/IP (Ethernet)

Supported series: Modbus RTU TCP/IP device.

Website: <http://www.modbus.org>

HMI Setting:

Parameters	Recommend	Option	Notes
PLC type	MODBUS TCP/IP (Ethernet)		
PLC I/F	Ethernet		
PLC st. no.	1	0~255	
Port no.	502		

Device Address:

Bit/Word	Device type	Format	Range	Memo
B	1x	DDDDD	1 ~ 65535	Output bit
B	0x	DDDDD	1 ~ 65535	Input bit
B	0x_multi_coils	DDDDD	1 ~ 65535	Write Multiple Coils
B	3x_bit	DDDDDdd	100 ~ 6553515	Input Register bit (read only)
B	4x_bit	DDDDDdd	100 ~ 6553515	Output Register bit
B	6x_bit	DDDDDdd	100 ~ 6553515	Output Register bit
W	3x	DDDDD	1 ~ 65535	Input Register
W	4x	DDDDD	1 ~ 65535	Output Register
DW	5x	DDDDD	1 ~ 65535	4x double word swap
W	6x	DDDDD	1 ~ 65535	4x single word write

Wiring Diagram:

Direct connect (crossover cable):

HMI RJ45 Female	Wire Color	PLC RJ45 Female
1 TX+	White/Orange	3 RX+
2 TX-	Orange	6 RX-
3 RX+	White/Green	1 TX+
4 BD4+	Blue	4 BD4+
5 BD4-	White/Blue	5 BD4-
6 RX-	Green	2 TX-
7 BD3+	White/Brown	7 BD3+
8 BD3-	Brown	8 BD3-



Through a hub:

HMI RJ45 Female	Wire Color	PLC RJ45 Female
1 TX+	White/Orange	1 TX+
2 TX-	Orange	2 TX-
3 RX+	White/Green	3 RX+
4 BD4+	Blue	4 BD4+
5 BD4-	White/Blue	5 BD4-
6 RX-	Green	6 RX-
7 BD3+	White/Brown	7 BD3+
8 BD3-	Brown	8 BD3-



Driver Version:

Version	Date	Description
V1.50	Aug/26/2009	

MODBUS TCP/IP (zero-based addressing)

Supported series : Modbus RTU TCP/IP device.

Website: <http://www.modbus.org>

HMI Setting:

Parameters	Recommend	Option	Notes
PLC type	MODBUS TCP/IP (zero-based addressing)		
PLC i/F	Ethernet		
PLC st. no.	1	0~255	
Port no.	502		

Device Address:

Bit/Word	Device type	Format	Range	Memo
B	1x	DDDDD	0 ~ 65535	Output bit
B	0x	DDDDD	0 ~ 65535	Input bit
B	0x_multi_coils	DDDDD	0 ~ 65535	Write Multiple Coils
B	3x_bit	DDDDDdd	0 ~ 6553515	Input Register bit (read only)
B	4x_bit	DDDDDdd	0 ~ 6553515	Output Register bit
B	6x_bit	DDDDDdd	0 ~ 6553515	Output Register bit
W	3x	DDDDD	0 ~ 65535	Input Register
W	4x	DDDDD	0 ~ 65535	Output Register
DW	5x	DDDDD	0 ~ 65535	4x double word swap
W	6x	DDDDD	0 ~ 65535	4x single word write

Wiring Diagram:

Direct connect (crossover cable):

HMI RJ45 Female	Wire Color	PLC RJ45 Female
1 TX+	White/Orange	3 RX+
2 TX-	Orange	6 RX-
3 RX+	White/Green	1 TX+
4 BD4+	Blue	4 BD4+
5 BD4-	White/Blue	5 BD4-
6 RX-	Green	2 TX-
7 BD3+	White/Brown	7 BD3+
8 BD3-	Brown	8 BD3-



Through a hub:

HMI RJ45 Female	Wire Color	PLC RJ45 Female
1 TX+	White/Orange	1 TX+
2 TX-	Orange	2 TX-
3 RX+	White/Green	3 RX+
4 BD4+	Blue	4 BD4+
5 BD4-	White/Blue	5 BD4-
6 RX-	Green	6 RX-
7 BD3+	White/Brown	7 BD3+
8 BD3-	Brown	8 BD3-



Driver Version:

Version	Date	Description
V1.40	Aug/27/2009	

MODBUS TCP/IP 32Bit

Supported series: Modbus RTU TCP/IP device.

Website: <http://www.modbus.org>

HMI Setting:

Parameters	Recommend	Option	Notes
PLC type	MODBUS TCP/IP 32Bit		
PLC I/F	Ethernet		
PLC st. no.	1	0~255	
Port no.	502		

Device Address:

Bit/Word	Device type	Format	Range	Memo
B	1x	DDDDD	1 ~ 65535	Output bit
B	0x	DDDDD	1 ~ 65535	Input bit
B	0x_multi_coils	DDDDD	1 ~ 65535	Write Multiple Coils
B	3x_bit	DDDDDdd	100 ~ 6553515	Input Register bit (read only)
B	4x_bit	DDDDDdd	100 ~ 6553515	Output Register bit
B	6x_bit	DDDDDdd	100 ~ 6553515	Output Register bit
W	3x	DDDDD	1 ~ 65535	Input Register
W	4x	DDDDD	1 ~ 65535	Output Register
DW	5x	DDDDD	1 ~ 65535	4x double word swap
W	6x	DDDDD	1 ~ 65535	4x single word write
W	4x_32Bit	DDDDD	1 ~ 65535	

Wiring Diagram:

Direct connect (crossover cable):

HMI RJ45 Female	Wire Color	PLC RJ45 Female
1 TX+	White/Orange	3 RX+
2 TX-	Orange	6 RX-
3 RX+	White/Green	1 TX+
4 BD4+	Blue	4 BD4+
5 BD4-	White/Blue	5 BD4-
6 RX-	Green	2 TX-
7 BD3+	White/Brown	7 BD3+
8 BD3-	Brown	8 BD3-



Through a hub:

HMI RJ45 Female	Wire Color	PLC RJ45 Female
1 TX+	White/Orange	1 TX+
2 TX-	Orange	2 TX-
3 RX+	White/Green	3 RX+
4 BD4+	Blue	4 BD4+
5 BD4-	White/Blue	5 BD4-
6 RX-	Green	6 RX-
7 BD3+	White/Brown	7 BD3+
8 BD3-	Brown	8 BD3-



Driver Version:

Version	Date	Description
V1.00	Aug/27/2009	Driver released.

Moeller XC-CPU101

Supported series: MOELLER XC100/200 series

Website: <http://www.moeller.net>

HMI Setting:

Parameters	Recommend	Option	Notes
PLC type	Moeller XC-CPU101		
PLC i/F	RS232		
Baud rate	38400	4800~57600	
Parity	None		
Data bits	8		
Stop bits	1		
PLC st. no.	1		

Device Address:

Bit/Word	Device type	Format	Range	Note
B	QX	DDo	0 ~ 157	
B	IX	DDo	0 ~ 157	
W	MW	DDDD	0 ~ 4095	
W	QW	DD	0 ~ 15	
W	IW	DD	0 ~ 15	

Wiring Diagram:

9P D-Sub to 8P RJ45:

HMI COM1 RS232 9P D-Sub Male	HMI COM2 RS232 9P D-Sub Male	HMI COM3 RS232 9P D-Sub Female	PLC RS232 8P RJ45
2 RX	6 RX	8 RX	5 TD
3 TX	4 TX	7 TX	8 RD
5 GND	5 GND	5 GND	4 GND



Driver Version:

Version	Date	Description
1.00	Apr/01/2010	Driver released.

Modicon Twido

Website : <http://www.modicon.com/>

HMI Setting:

Parameters	Recommend	Option	Notes
PLC type	Modbus RTU		Support Extended Address mode.
PLC I/F	RS485	RS232/RS485	
Baud rate	19200	19200	
Parity	None	Even, Odd, None	
Data bits	8	8	Must set 8 for RTU mode
Stop bits	1	1	Must set 8 for RTU mode
PLC st. no.	1	0-247	

PLC Setting:

Communication mode	19200, None, 8, 1
Select	Modbus RTU Slave

Device Address:

Bit/Word	Device type	Format	Range	Memo
B	0x or 1x	dddd	0 ~ 9999	%Mi
W	3x or 4x	dddd	0 ~ 9999	%MWi

Wiring Diagram:

9P D-Sub to 8P Mini-DIN:

HMI COM1 RS485 2W 9P D-Sub Female	HMI COM3 RS485 2W 9P D-Sub Female		Port1 RS485 8P Mini-DIN	
1 RX-	6 Data-		2 B-	
2 RX+	9 Data+		1 A+	
5 GND	5 GND		5 DTP	circuit
			7 GND	



9P D-Sub to Terminals:

HMI COM1 RS485 2W 9P D-Sub Female	HMI COM3 RS485 2W 9P D-Sub Female		Port2 RS485 3P Terminals	
1 RX-	6 Data-		B-	
2 RX+	9 Data+		A+	
5 GND	5 GND		GND	

9P D-Sub to 9P D-Sub:

HMI COM1 RS232 9P D-Sub Male	HMI COM2 RS232 9P D-Sub Male	HMI COM3 RS232 9P D-Sub Female	Port2 RS232 9P D-Sub	
2 RX	6 RX	8 RX	3 TX	
3 TX	4 TX	7 TX	2 RX	
5 GND	5 GND	5 GND	5 GND	



OEMAX Series

Supported series: OEMax NX7/NX7s Controllers.

Website: <http://www.oemax.co.kr>

HMI Setting:

Parameters	Recommend	Option	Notes
PLC type	OEMAX Series		
PLC I/F	RS232		
Baud rate	9600	9600, 19200, 38400	
Parity	None	Even, Odd, None	
Data bits	8	8	
Stop bits	1	1	
PLC st. no.	0		

Device Address:

Bit/Word	Device type	Format	Range	Memo
B	R	DDDdd	0 ~ 25515	
B	L	DDDdd	0 ~ 25515	
B	M	DDDDdd	0 ~ 199915	
B	K	DDDdd	0 ~ 25515	Keep contact
B	F	DDDdd	0 ~ 99115	Special contact
B	TC	DDD	0 ~ 255	Timer/Counter
W	W	DDDD	0 ~ 7999	Data register
W	SV	DDD	0 ~ 255	Timer/Counter Set Value
W	PV	DDD	0 ~ 255	Timer/Counter Preset Value
W	SR	DDD	0 ~ 255	Special register
W	WR	DDD	0 ~ 255	
W	WL	DDD	0 ~ 255	
W	WM	DDDD	0 ~ 1999	
W	WK	DDD	0 ~ 255	
W	WF	DDD	0 ~ 991	

Wiring Diagram:

9P D-Sub to 9P D-Sub:

HMI COM1 RS232 9P D-Sub Male	HMI COM2 RS232 9P D-Sub Male	HMI COM3 RS232 9P D-Sub Female	PLC Port1 RS232 9P D-Sub Female
2 RX	6 RX	8 RX	2 TXD
3 TX	4 TX	7 TX	3 RXD
5 GND	5 GND	5 GND	5 GND



Driver Version:

Version	Date	Description
V1.00	Dec/30/2008	Driver released.

OMRON C/CQM1 Series

Supported series: OMRON C, CPM, CPL, CQM Series (Host Link Protocol)

Website: <http://oeiweb.omron.com/oei/Products-PLC.htm>

HMI Setting:

Parameters	Recommend	Option	Notes
PLC type	OMRON C/CQM1 Series		
PLC I/F	RS232	RS232, RS422, RS485	
Baud rate	9600	9600, 19200	
Parity	Even	Even, Odd, None	
Data bits	7	7 or 8	
Stop bits	2	1 or 2	
PLC st. no.	0	0-31	Host Link Station No.

Online Simulator	YES	Broadcast command	YES
Extend address mode	YES		

PLC Setting:

Communication mode	Host Link protocol
--------------------	--------------------

Device Address:

Bit/Word	Device type	Format	Range	Memo
B	IR	DDDDdd	0 ~ 409515	I/O and internal Relay
B	HR	DDDDdd	0 ~ 409515	Hold Relay
B	LR	DDDDdd	0 ~ 409515	Link Relay
B	IR (Force Set/Reset)	DDDDdd	0 ~ 409515	
B	HR(Force Set/Reset)	DDDDdd	0 ~ 409515	
B	LR(Force Set/Reset)	DDDDdd	0 ~ 409515	
B	AR	DDDDdd	0 ~ 409515	Auxiliary Relay
W	AR_W	DDDD	0 ~ 4095	
W	IR W	DDDD	0 ~ 4095	

W	HR_W	DDDD	0 ~ 4095	
W	LR_W	DDDD	0 ~ 4095	
W	TC	DDD	0 ~ 255	
W	DM	DDDD	0 ~ 9999	Data register

Wiring Diagram:

CPU Port (CPM2A,CQM1/1H,C200H/HS/ALPHA series)

Communication Module:

CPM1-CIF01 adapter (for CPM1/CPM1A/CPM2A series, CQM1/CQM1H series)

CPM1H-SCB41 communication module (for CQM1H-CPU51/61)

9P D-Sub to 9P D-Sub:

HMI COM1 RS232 9P D-Sub Male	HMI COM2 RS232 9P D-Sub Male	HMI COM3 RS232 9P D-Sub Female	OMRON CPU RS232 9P D-Sub	
2 RX	6 RX	8 RX	2 SD	
3 TX	4 TX	7 TX	3 RD	
5 GND	5 GND	5 GND	9 GND	
			4 RS	circuit
			5 CS	



C200h-LK201,3G2A6-LK201 communication module

C200HW-COM02/03/04/05/06 communication module

9P D-Sub to 9P D-Sub:

HMI COM1 RS232 9P D-Sub Male	HMI COM2 RS232 9P D-Sub Male	HMI COM3 RS232 9P D-Sub Female	OMRON CPU RS232 9P D-Sub	
2 RX	6 RX	8 RX	2 SD	
3 TX	4 TX	7 TX	3 RD	
5 GND	5 GND	5 GND	7 GND	
			4 RS	circuit
			5 CS	

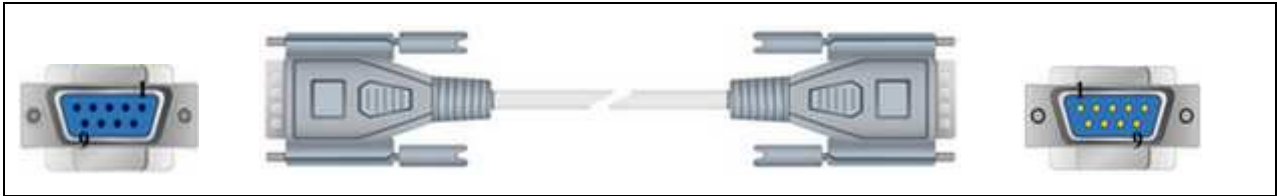

Driver Version:

Version	Date	Description
V1.80	Apr/14/2010	

OMRON CJ/CS/CP

Supported series: OMRON CP1L, CP1H, CJ1M, CJ1H, CJ1G, CS1H and CS1G. (Host Link Protocol FINS command), this driver supports Extend Addressing mode.

Website: <http://oeiweb.omron.com/oei/Products-PLC.htm>

HMI Setting:

Parameters	Recommend	Option	Notes
PLC type	OMRON CJ/CS/CP		
PLC I/F	RS232	RS232, RS422, RS485	
Baud rate	9600	9600~115200	
Parity	Even	Even, Odd, None	
Data bits	7	7 or 8	
Stop bits	2	1 or 2	
PLC st. no.	0	0-31	Host Link Station No.

Online Simulator	YES	Extend address mode	YES
Broadcast command	NO		

PLC Setting:

Communication mode	Host Link protocol
--------------------	--------------------

Device Address:

Bit/Word	Device type	Format	Range	Memo
B	D_Bit	DDDDDDdd	0 ~ 3276715	Data Memory (DM)
B	H_Bit	DDDDDDdd	0 ~ 3276715	Holding Area (HR)
B	W_Bit	DDDDDDdd	0 ~ 3276715	Work Area (WR)
B	CIO_Bit	DDDDDDdd	0 ~ 3276715	Channel I/O (CIO)
B	A_Bit	DDDDDDdd	0 ~ 3276715	Auxiliary Relay (AR)
B	T_Bit	DDDDDDdd	0 ~ 3276715	Timer (TIM)
B	C_Bit	DDDDDDdd	0 ~ 3276715	Counter (CNT)
B	C_flag	DDDD	0 ~ 4095	

Bit/Word	Device type	Format	Range	Memo
B	F_flag	DDDD	0 ~ 4095	
W	D	DDDDD	0 ~ 32767	Data Memory (DM)
W	H	DDDDD	0 ~ 32767	Holding Area (HR)
W	W	DDDDD	0 ~ 32767	Work Area (WR)
W	CIO	DDDDD	0 ~ 32767	Channel I/O (CIO)
W	A	DDDDD	0 ~ 32767	Auxiliary Relay (AR)
W	T	DDDDD	0 ~ 32767	Timer (TIM)
W	C	DDDDD	0 ~ 32767	Counter (CNT)
W	EM0 ~ EMC	DDDDD	0 ~ 32767	Extend Memory

Wiring Diagram:

9P D-Sub to 9P D-Sub:

HMI COM1 RS232 9P D-Sub Male	HMI COM2 RS232 9P D-Sub Male	HMI COM3 RS232 9P D-Sub Female	OMRON CPU RS232 9P D-Sub	
2 RX	6 RX	8 RX	2 SD	
3 TX	4 TX	7 TX	3 RD	
5 GND	5 GND	5 GND	9 GND	
			4 RS	circuit
			5 CS	



9P D-Sub to Terminals: CP1H/CP1L CP1W-CIF11 RS422

HMI COM1 RS485 4W 9P D-Sub Female			CP1W-CIF11 RS422 Terminals
1 RX-			SDA
2 RX+			SDB
3 TX-			RDA
4 TX+			RDB
5 GND			FG

CP1W-CIF11: SW1 ON, others OFF.

Driver Version:

Version	Date	Description
V1.70	Mar/24/2010	

OMRON CJ1/CS1 (Ethernet)

Supported series: OMRON CJ1M, CJ1H, CJ1G, CS1H, and CS1G. (Ethernet FINS)

Website: <http://oeiweb.omron.com/oei/Products-PLC.htm>

HMI Setting:

Parameters	Recommend	Option	Notes
PLC type	OMRON CJ1/CS1 (Ethernet)		
PLC I/F	Ethernet		
Port no.	9600		
PLC st. no.	0		

PLC Setting:

Communication mode	FINS Ethernet protocol
--------------------	------------------------

Device Address:

Bit/Word	Device type	Format	Range	Memo
B	D_Bit	DDDDDDdd	0 ~ 3276715	Data Memory (DM)
B	H_Bit	DDDDDDdd	0 ~ 3276715	Holding Area (HR)
B	W_Bit	DDDDDDdd	0 ~ 3276715	Work Area (WR)
B	CIO_Bit	DDDDDDdd	0 ~ 3276715	Channel I/O (CIO)
B	A_Bit	DDDDDDdd	0 ~ 3276715	Auxiliary Relay (AR) (Read only)
B	T_Bit	DDDDDDdd	0 ~ 3276715	Timer (TIM)
B	C_Bit	DDDDDDdd	0 ~ 3276715	Counter (CNT)
B	C_Flag	DDDD	0 ~ 4095	
B	T_Flag	DDDD	0 ~ 4095	
W	D	DDDDDD	0 ~ 32767	Data Memory (DM)
W	H	DDDDDD	0 ~ 32767	Holding Area (HR)
W	W	DDDDDD	0 ~ 32767	Work Area (WR)
W	CIO	DDDDDD	0 ~ 32767	Channel I/O (CIO)

W	A	DDDDD	0 ~ 32767	Auxiliary Relay (AR) (Read only)
W	T	DDDDD	0 ~ 32767	Timer (TIM)
W	C	DDDDD	0 ~ 32767	Counter (CNT)
W	EM0 ~ EMC	DDDDD	0 ~ 32767	Extend Memory

Wiring Diagram:

Direct connect (crossover cable):

HMI RJ45 Female	Wire Color	PLC RJ45 Female
1 TX+	White/Orange	3 RX+
2 TX-	Orange	6 RX-
3 RX+	White/Green	1 TX+
4 BD4+	Blue	4 BD4+
5 BD4-	White/Blue	5 BD4-
6 RX-	Green	2 TX-
7 BD3+	White/Brown	7 BD3+
8 BD3-	Brown	8 BD3-



Through a hub:

HMI RJ45 Female	Wire Color	PLC RJ45 Female
1 TX+	White/Orange	1 TX+
2 TX-	Orange	2 TX-
3 RX+	White/Green	3 RX+
4 BD4+	Blue	4 BD4+
5 BD4-	White/Blue	5 BD4-
6 RX-	Green	6 RX-
7 BD3+	White/Brown	7 BD3+
8 BD3-	Brown	8 BD3-



Driver Version:

Version	Date	Description
V1.50	Jun/30/2010	

OMRON E5CN

Supported series: OMRON E5CN series temperature controller with communication option. E5EN/CN/GN/EZ/ZN series.

Website: <http://oeiweb.omron.com>

HMI Setting:

Parameters	Recommend	Option	Notes
PLC type	OMRON E5CN		
PLC I/F	RS485 2W		
Baud rate	9600	9600/19200/38400/ 57600/115200	
Parity	Even	Even, Odd, None	
Data bits	7	7,8	
Stop bits	2	1,2	
PLC st. no.	0	0-99	

Online Simulator	YES	Broadcast command	YES
Extend address mode	YES		

Device Address:

Bit/Word	Device type	Format	Range	Memo
B	Status_CH1	DD	0 ~ 31	Page40
B	Status_CH2	DD	0 ~ 31	
DW	C0	HHHH	0 ~ 270f	Read only (Hex) Page34
DW	C1	HHHH	0 ~ 270f	Read/Write (Hex) Page35
DW	C21	HHHH	0 ~ 270f	Read/Write (Hex) Page35
DW	C3	HHHH	0 ~ 270f	Read/Write (Hex) Page36
W	Code00_00	H	0	Communications writing OFF (disabled)
W	Code00_01	H	0	Communications writing ON(Enabled)
W	Code01_00	H	0	Run
W	Code01_01	H	0	Stop
W	Code02_00	H	0	Multi-SP Set point 0

Bit/Word	Device type	Format	Range	Memo
W	Code02_01	H	0	Multi-SP Set point 1
W	Code02_02	H	0	Multi-SP Set point 2
W	Code02_03	H	0	Multi-SP Set point 3
W	Code03_00	H	0	AT cancel
W	Code03_01	H	0	AT execute
W	Code04_00	H	0	Write mode (Backup)
W	Code04_01	H	0	Write mode (Ram)
W	Code05_00	H	0	Save RAM data
W	Code06_00	H	0	Software reset
W	Code07_00	H	0	Move to setup area 1
W	Code08_00	H	0	Move to protect level

Wiring Diagram:

9P D-Sub to 9P D-Sub:

HMI COM1 RS485 2W 9P D-Sub Female	HMI COM3 RS485 2W 9P D-Sub Female		OMRON E5CN
1 RX-	6 Data-		12 B
2 RX+	9 Data+		11 A
5 GND	5 GND		GND



Note:

For communication with OMRON E5EZ, please set communication setting to 9600, E, 7, 2, station no. to 1.

Driver Version:

Version	Date	Description
V1.21	Dec/21/2010	

Panasonic FP

Supported series: NAIS (Matsushita) FP series include FP-X, FP-Σ, FP0, FP1, FP2, FP2SH, FP10SH and FP3 Ethernet support FP-X with AFPX-COM5.

Website: <http://pewa.panasonic.com/>

HMI Setting:

Parameters	Recommend	Option	Notes
PLC type	Panasonic FP		
PLC I/F	RS232	RS232/RS485	
Baud rate	9600	9600, 19200, 38400, 57600, 115200	
Parity	Odd	Even, Odd, None	
Data bits	8	7 or 8	
Stop bits	1	1 or 2	
PLC st. no.	1	0-255	Must match the PLC's port setting. FP3 must set 0.

Device Address:

Bit/Word	Device type	Format	Range	Memo
B	X	DDDDh	0 ~ 9999f	Input(X)
B	Y	DDDDh	0 ~ 9999f	Output(Y)
B	R	DDDDh	0 ~ 9999f	Internal Relay(R)
B	L	DDDD	0 ~ 9999	Link Relay(L)
B	L_Bit	DDDDh	0 ~ 9999f	
B	T	DDDD	0 ~ 9999	Timer(T)
B	C	DDDD	0 ~ 9999	Counter(C)
W	SV	DDDD	0 ~ 9999	Timer/Counter set value(SV)
W	EV	DDDDD	0 ~ 65535	Timer/Counter elapse value(EV)
W	DT	DDDDD	0 ~ 99999	Data Register(DT)
W	LD	DDDD	0 ~ 8447	Link Register(LD)
W	WX	DDDD	0 ~ 9999	Input(WX) (read only)

W	WY	DDDD	0 ~ 9999	Output(WY)
W	WR	DDDD	0 ~ 9999	Internal Relay(WR)
W	WL	DDDD	0 ~ 9999	Link Relay(WL)
W	FL	DDDDD	0 ~ 99999	File register(FL)

Wiring Diagram:

9P D-Sub to 5P Mini-DIN:

HMI COM1 RS232 9P D-Sub Male	HMI COM2 RS232 9P D-Sub Male	HMI COM3 RS232 9P D-Sub Female	FP0, FP2, FP2SH, FPM CPU Tool Port RS232 5P Mini-DIN
2 RX	6 RX	8 RX	2 TXD
3 TX	4 TX	7 TX	3 RXD
5 GND	5 GND	5 GND	1 GND



9P D-Sub to 3P Terminals:

HMI COM1 RS232 9P D-Sub Male	HMI COM2 RS232 9P D-Sub Male	HMI COM3 RS232 9P D-Sub Female	FP0 CPU RS232 3P Terminals
2 RX	6 RX	8 RX	S
3 TX	4 TX	7 TX	R
5 GND	5 GND	5 GND	G

9P D-Sub to 9P D-Sub:

HMI COM1 RS232 9P D-Sub Male	HMI COM2 RS232 9P D-Sub Male	HMI COM3 RS232 9P D-Sub Female	FP1, FP2, FP2SH, FP10SH CPU RS232 9P D-Sub	
2 RX	6 RX	8 RX	2 TXD	
3 TX	4 TX	7 TX	3 RXD	
5 GND	5 GND	5 GND	7 GND	
			4 RTS	circuit
			5 CTS	
			8 CD	circuit
			9 ER	
				

9P D-Sub to 8P MiniDIN:

HMI COM1 RS485 4W 9P D-Sub Female			FP1 CPU RS422 8P Hirose	
1 RX-			2 TXDA	
2 RX+			5 TXDB	
3 TX-			3 RXDA	
4 TX+			6 RXDB	
5 GND			1 GND	
				

9P D-Sub to 15P D-Sub:

HMI COM1 RS485 4W 9P D-Sub Female			FP3 CPU RS422 15P D-Sub	
1 RX-			9 TXDA	
2 RX+			2 TXDB	
3 TX-			10 RXDA	
4 TX+			3 RXDB	
5 GND			7 GND	
			4 RTS+	circuit
			5 CTS+	
			11 RTS-	circuit
			12 CTS-	
				

Driver Version:

Version	Date	Description
V1.80	Apr/09/2010	Add FL device type.

Panasonic FP (Ethernet)

Supported series: NAIS (Matsushita) FP series include FP-X, FP-Σ, FP0, FP1, FP2, FP2SH, FP10SH and FP3 Ethernet support FP-X with AFPX-COM5.

Website: <http://pewa.panasonic.com/>

HMI Setting:

Parameters	Recommend	Option	Notes
PLC type	Panasonic FP (Ethernet)		
PLC I/F	Ethernet		
Port no.	9094		
PLC st. no.	1	0~255	

Device Address:

Bit/Word	Device type	Format	Range	Memo
B	X	DDDDh	0 ~ 9999f	Input(X)
B	Y	DDDDh	0 ~ 9999f	Output(Y)
B	R	DDDDh	0 ~ 9999f	Internal Relay(R)
B	L	DDDD	0 ~ 9999	Link Relay(L)
B	L_Bit	DDDDh	0 ~ 9999f	
B	T	DDDD	0 ~ 9999	Timer(T)
B	C	DDDD	0 ~ 9999	Counter(C)
W	SV	DDDD	0 ~ 9999	Timer/Counter set value(SV)
W	EV	DDDDD	0 ~ 65535	Timer/Counter elapse value(EV)
W	DT	DDDDD	0 ~ 99999	Data Register(DT)
W	LD	DDDD	0 ~ 8447	Link Register(LD)
W	WX	DDDD	0 ~ 9999	Input(WX) (read only)
W	WY	DDDD	0 ~ 9999	Output(WY)
W	WR	DDDD	0 ~ 9999	Internal Relay(WR)
W	WL	DDDD	0 ~ 9999	Link Relay(WL)
W	FL	DDDDD	0 ~ 99999	File register(FL)

Wiring Diagram:

Direct connect (crossover cable):

HMI RJ45 Female	Wire Color	PLC RJ45 Female
1 TX+	White/Orange	3 RX+
2 TX-	Orange	6 RX-
3 RX+	White/Green	1 TX+
4 BD4+	Blue	4 BD4+
5 BD4-	White/Blue	5 BD4-
6 RX-	Green	2 TX-
7 BD3+	White/Brown	7 BD3+
8 BD3-	Brown	8 BD3-

Through a hub:

HMI RJ45 Female	Wire Color	PLC RJ45 Female
1 TX+	White/Orange	1 TX+
2 TX-	Orange	2 TX-
3 RX+	White/Green	3 RX+
4 BD4+	Blue	4 BD4+
5 BD4-	White/Blue	5 BD4-
6 RX-	Green	6 RX-
7 BD3+	White/Brown	7 BD3+
8 BD3-	Brown	8 BD3-

Ethernet connect

TCP port: 9094

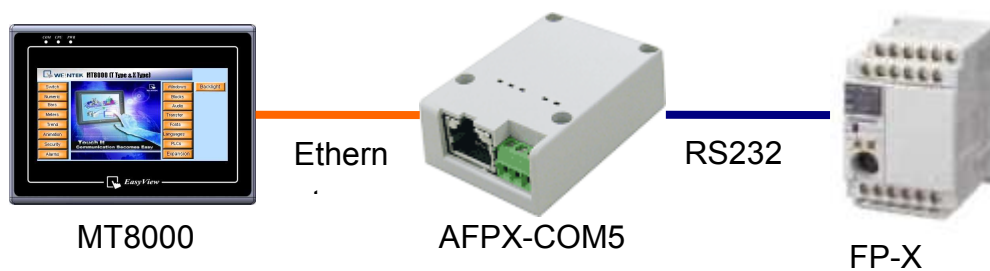

Driver Version:

Version	Date	Description
V1.80	Apr/12/2010	

Panasonic FP2 (Ethernet)

Supported series: NAIS (Matsushita) FP2 series include FP2, FP2SH, and FP10SH CPU.

Website: <http://pewa.panasonic.com/>

HMI Setting:

Parameters	Recommend	Option	Notes
PLC type	Panasonic FP2 (Ethernet)		
PLC I/F	Ethernet		
Port no.	8500		
PLC st. no.	2	0~255	

Device Address:

Bit/Word	Device type	Format	Range	Memo
B	X	DDDDh	0 ~ 9999f	Input(X)
B	Y	DDDDh	0 ~ 9999f	Output(Y)
B	R	DDDDh	0 ~ 9999f	Internal Relay(R)
B	L	DDDD	0 ~ 9999	Link Relay(L)
B	L_Bit	DDDDh	0 ~ 9999f	
B	T	DDDD	0 ~ 9999	Timer(T)
B	C	DDDD	0 ~ 9999	Counter(C)
W	SV	DDDD	0 ~ 9999	Timer/Counter set value(SV)
W	EV	DDDDD	0 ~ 65535	Timer/Counter elapse value(EV)
W	DT	DDDDD	0 ~ 99999	Data Register(DT)
W	LD	DDDD	0 ~ 8447	Link Register(LD)
W	WX	DDDD	0 ~ 9999	Input(WX) (read only)
W	WY	DDDD	0 ~ 9999	Output(WY)
W	WR	DDDD	0 ~ 9999	Internal Relay(WR)
W	WL	DDDD	0 ~ 9999	Link Relay(WL)

Wiring Diagram:

Direct connect (crossover cable):

HMI RJ45 Female	Wire Color	PLC RJ45 Female
1 TX+	White/Orange	3 RX+
2 TX-	Orange	6 RX-
3 RX+	White/Green	1 TX+
4 BD4+	Blue	4 BD4+
5 BD4-	White/Blue	5 BD4-
6 RX-	Green	2 TX-
7 BD3+	White/Brown	7 BD3+
8 BD3-	Brown	8 BD3-



Through a hub:

HMI RJ45 Female	Wire Color	PLC RJ45 Female
1 TX+	White/Orange	1 TX+
2 TX-	Orange	2 TX-
3 RX+	White/Green	3 RX+
4 BD4+	Blue	4 BD4+
5 BD4-	White/Blue	5 BD4-
6 RX-	Green	6 RX-
7 BD3+	White/Brown	7 BD3+
8 BD3-	Brown	8 BD3-



Driver Version:

Version	Date	Description
V1.00	Mar/11/2010	Driver released.

Panasonic MINAS A4

Supported series: Panasonic MINAS A4 series Servo Drive.

HMI Setting:

Parameters	Recommend	Option	Notes
PLC type	Panasonic MINAS A4		
PLC I/F	RS232		
Axis no.	0 (master station only)	0 ~ F (slave)	
Baud rate	9600		
Parity	None		
Data bits	8		
Stop bits	1		

Device Address:

Bit/Word	Device type	Format	Range	Memo
B	Command 20	D	0 ~ 7	States (Note 3)
B	Command 27	DD	0 ~ 31	input signal (Note 3)
B	Command 28	DD	0 ~ 31	output signal (Note 3)
W	Command 01	D	0	cpu version (Numeric format: 16-bit Hex)
W	Command 05	DD	0 ~ 11	driver version (ASCII / 12 words)
W	Command 06	DD	0 ~ 11	motor version (ASCII / 12 words)
W	Command 21	D	0 ~ 1	command pulse counter (Numeric format: 32-bit Signed)
W	Command 22	D	0 ~ 1	feedback pulse counter (Numeric format: 32-bit Signed)
W	Command 24	D	0	present speed (Numeric format: 16-bit Unsigned)
W	Command 25	D	0	present torque (Numeric format: 16-bit Unsigned)
W	Command 26	D	0 ~ 1	present deviation counter (Numeric format: 32-bit Signed)
W	Command 84	D	0	write parameter to EEPROM (Note 1)
W	Command 90	D	0	present Alarm Data

				(Numeric format: 16-bit Unsigned)
W	Command 91	DD	1 ~ 14	Alarm History (Note 4) (Numeric format: 16-bit Unsigned)
W	Command 92	DD	1 ~ 14	Batch Alarm (Note 4) (Numeric format: 16-bit Unsigned)
W	Command 93	D	0	clear alarm history (include EEPROM) (Note 1)
W	Command 94	D	0	alarm clear (Note 1)
W	Command 9B	D	0	Absolute clear (Note 1)
W	Parameter	HH	0 ~ 7f	Individual Parameter (range: 0x00 ~ 0x7F) (Note 2)

Note:

- Command 84, Command 93, Command 94, and Command 9B are write only. (These commands are able to use Set Bit Object and execute the write command after trigger Set Bit Object.). Except these four commands, others are read only.
- Parameter read/write: Use Device type to define address control from 00~7F
For example: "address_00" is mapping to "Parameter_00". (Please refer detail with Panasonic MINAS A4 series user manual.)
- Device address type can define MINAS A4 Driver's command list.
Command 20, Command 27, and Command 28 are Bit type, use "Operating range" to map communication order status.
For example: "Command 20_3" means "Read state_CCW."
(Please refer detail with Panasonic MINAS A4 series user manual)
- Command 91 and Command 92 are word type, use "Operating range" to map the record of 14 alarms.
For example: "Command 91_1" means "Read alarm data_First alarm."

Wiring Diagram:

9P D-Sub to 8P Mini-DIN:

HMI COM1 RS232 9P D-Sub Male	HMI COM2 RS232 9P D-Sub Male	HMI COM3 RS232 9P D-Sub Female	MINAS A4 Driver CNX4 Port RS232 8P Mini-DIN
2 RX	6 RX	8 RX	3 TXD
3 TX	4 TX	7 TX	5 RXD
5 GND	5 GND	5 GND	4 GND

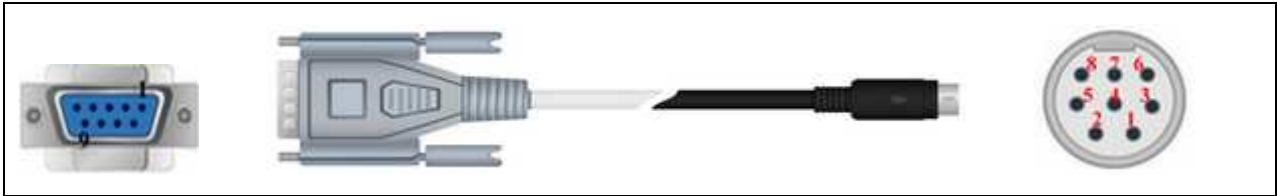

9P D-Sub to 8P Mini-DIN:

HMI COM1 RS485 2W 9P D-Sub Female	HMI COM3 RS485 2W 9P D-Sub Female		MINAS A4 Driver CNX3/CNX4 Port RS485 2W 8P Mini-DIN
1 RX-	6 Data-		7 D-
2 RX+	9 Data+		8 D+
5 GND	5 GND		



<p>8P Mini-Din Female MINAS A4 Driver CNX3 / CNX4 Port</p>	MINAS A4 Driver CNX3 Port	MINAS A4 Driver CNX4 Port
	7 D-	3 TX
	8 D+	5 RX
	4 GND	4 GND
		7 D-
		8 D+

RS485 cable / DVOP1970-005

MINAS A4 Driver 8p Mini-DIN Male		MINAS A4 Driver 8p Mini-DIN Male
7 D-	—	7 D-
8 D+	—	8 D+
4 GND	—	4 GND

RS232 cable / DVOP1960

MINAS A4 Driver 9P D-SUB Female		MINAS A4 Driver 8p Mini-DIN Male
3 RXD	—	5 RXD
2 TXD	—	3 TXD
5 GND	—	4 GND

HMI connect with one Device

Weintek HMI

Com RS232

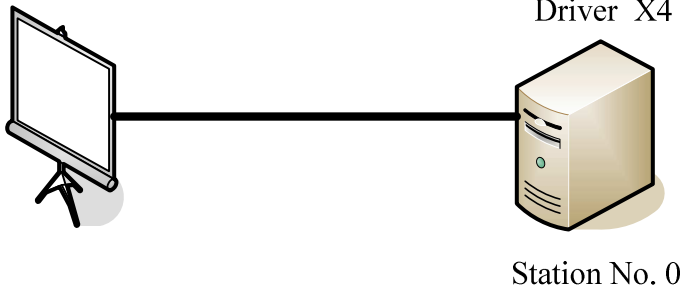

HMI connect with multi devices

Weintek HMI

Com RS232

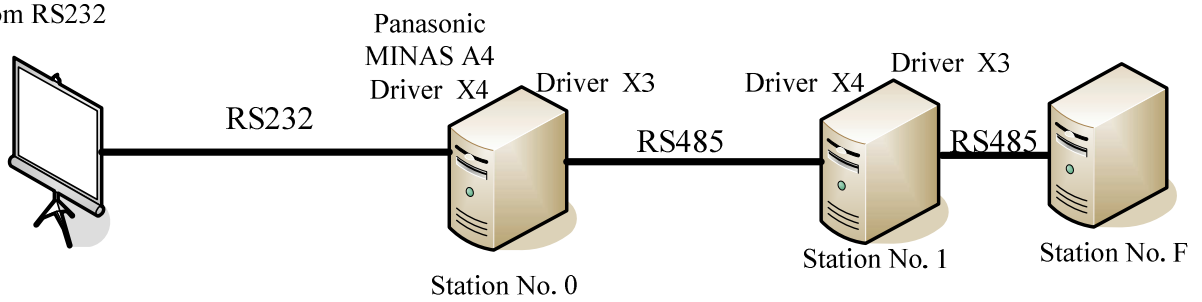

Driver Version:

Version	Date	Description
V1.10	Jan/11/2010	

Parker ACR9000

Supported series: Parker ACR9000.

Website: <http://www.parkermotion.com>

HMI Setting:

Parameters	Recommend	Option	Notes
PLC type	Parker ACR9000		
PLC I/F	RS232	RS485 4W / RS232	
Baud rate	38400	1200 - 38400	
Parity	None	Even, Odd, None	
Data bits	8	7,8	
Stop bits	1	1,2	
PLC st. no.	0		

Online Simulator	YES	Extend address mode	
------------------	-----	---------------------	--

Device Address:

Bit/Word	Device type	Format	Range	Memo
B	P_Low16bit	DDDDDDdd	0 ~ 9999915	
B	P_High16bit	DDDDDDdd	0 ~ 9999915	
W	P_Int32	DDDDDD	0 ~ 99999	
W	P_Float	DDDDDD	0 ~ 99999	

Wiring Diagram:

9P D-Sub to 9P D-Sub:

HMI COM1 RS232 9P D-Sub Male	HMI COM2 RS232 9P D-Sub Male	HMI COM3 RS232 9P D-Sub Female	Parker AC9000 RS232 Port 9P D-Sub
2 RX	6 RX	8 RX	3 TXD
3 TX	4 TX	7 TX	2 RXD
5 GND	5 GND	5 GND	5 GND



Driver Version:

Version	Date	Description
V1.00	Dec/30/2008	Driver released.

Parker Compax3

Supported series: Parker Compax3 Servo Drive.

Website: <http://www.parker.com>

HMI Setting:

RS232

Parameters	Recommend	Option	Notes
PLC type	Parker Compax3		
PLC I/F	RS232		
Baud rate	115200		
Parity	None	Even, Odd, None	
Data bits	8	7 or 8	
Stop bits	1	1 or 2	
PLC st. no.	0	0	Must be 0 for RS232

RS485

Parameters	Recommend	Option	Notes
PLC type	Parker Compax3		
PLC I/F	RS485 2W		
Baud rate	9600		
Parity	None	Even, Odd, None	
Data bits	8	7 or 8	
Stop bits	1	1 or 2	
PLC st. no.	1	1-99	Range from 1 to 99 for RS485, according to the PLC's setting.

PLC Setting:

How to setting Compax 3 servo to RS485 mode?

1. Open C3 ServoManager2, select "Communication" => "RS-485 Settings".

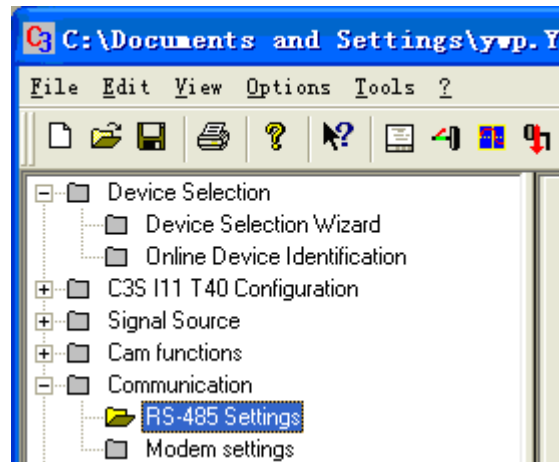

2. Click to Configure "RS-485/POP Settings".

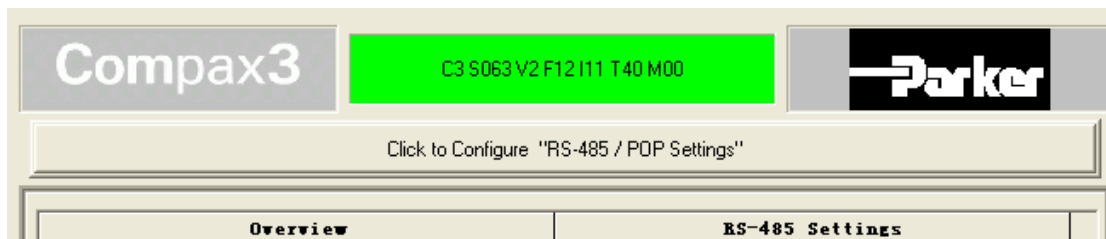

2. Setting parameters as below

Master General	
Multicast Address	98
Device Address	1
Baud rate	9600
Connection Type	Two wire
Parity	No
Stop bits	1
Data bits	8

4. Downloading settings to Compax3 Servo.

5. Setting EasyBuilder system parameter and connecting with PLC for communication of HMI and Servo.

Device Address:

Bit/Word	Device type	Format	Range	Memo
B	R_Low16bit	DDDDDDDDh	0 ~ 99999999f	
B	R_High16bit	DDDDDDDDh	0 ~ 99999999f	
DW	Register_Int	DDDDDD	0 ~ 999999	For Register is INT32 or U32
DW	Register_float	DDDDDD	0 ~ 999999	For Register is INT32 or U32
W	Register_Short	DDDDDD	0 ~ 999999	For Register is INT16 or U16

Wiring Diagram:

9P D-Sub to 9P D-Sub:

HMI COM1 RS232 9P D-Sub Male	HMI COM2 RS232 9P D-Sub Male	HMI COM3 RS232 9P D-Sub Female	Parker Compax3 PLC X10 9P D-Sub	
2 RX	6 RX	8 RX	3 TXD	
3 TX	4 TX	7 TX	2 RXD	
5 GND	5 GND	5 GND	5 GND	
				

9P D-Sub to 9P D-Sub:

HMI COM1 RS485 2W 9P D-Sub Female	HMI COM3 RS485 2W 9P D-Sub Female		Parker Compax3 PLC X10 9P D-Sub	
1 RX-	6 Data-		3 RXD	
2 RX+	9 Data+		7 TXD	
5 GND	5 GND		5 GND	
			1 nable RS485	circuit
			9 +5V	
				

Driver Version:

Version	Date	Description
V1.70	Mar/30/2009	

Parker SLVD Series

Supported series : Parker SLVD Servo, SLVD1N, SLVD2N, SLVD5N, SLVD7N, SLVD10N, SLVD15N, SLVD17N.

Website: <http://www.parker.com/portal/site/PARKER/>

HMI Setting:

Parameters	Recommend	Option	Notes
PLC type	Parker SLVD Series		
PLC I/F	RS485 4W		
Baud rate	9600	9600/19200	
Parity	Even	Even, Odd, None	
Data bits	8	7,8	
Stop bits	1	1,2	
PLC st. no.	0		0-31

Online Simulator	YES	Extend address mode	
------------------	-----	---------------------	--

Device Address:

Bit/Word	Device type	Format	Range	Memo
B	Par_Binary	DDDDdd	0 ~ 999915	Set a bit of Parameter
W	Par_One_Word	DDDD	0 ~ 9999	Set 2 bytes Parameter
W	Par_One_Byte	DDDD	0 ~ 9999	Set 1 byte Parameter
DW	Par_Two_Word	DDDD	0 ~ 9999	Set 4 bytes Parameter
W	RESET	D	0	
W	RUN	D	0	

Wiring Diagram:

9P D-Sub to 15P D-Sub:

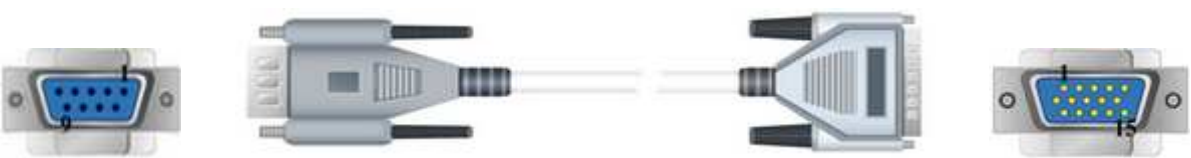
HMI COM1 RS485 4W 9P D-Sub Female			Parker SLVD Servo Serial Link X1 15P D-Sub	
1 RX-			7 TX-	
2 RX+			12 TX+	
3 TX-			2 RX-	
4 TX+			1 RX+	circuit
			6 TER	
5 GND			3 GND	
				

Driver Version:

Version	Date	Description
V1.00	Jan/27/2010	Driver released.

SAIA PCD PGU Mode

Supported series : SAIA PCD series PGU mode.

Website : <http://www.saia-burgess.com/>

HMI Setting:

Parameters	Recommend	Option	Notes
PLC type	SAIA PCD PGU Mode		PDS driver
PLC I/F	RS232	RS232, RS485	
Baud rate	9600	9600, 19200	
Parity	Even	Even, Odd, None	
Data bits	7	7,8	
Stop bits	1	1	
PLC st. no.	1	0-255	

Device Address:

Bit/Word	Device type	Format	Range	Memo
B	Flag	DDDD	0 ~ 8191	
B	Input	DDD	0 ~ 511	
B	Output	DDD	0 ~ 511	
W	Register	DDDD	0 ~ 4095	
W	Counter	DDDD	0 ~ 1599	
W	Timer	DDDD	0 ~ 1599	
W	Reg_Float	DDDD	0 ~ 4095	support single float point
W	Reg_Word	DDDD	0 ~ 4095	

Wiring Diagram:

9P D-Sub to 9P D-Sub:

HMI COM1 RS232 9P D-Sub Male			RS232 9P D-Sub	
2 RX			3 TXD	
3 TX			2 RXD	
5 GND			5 GND	
7 RTS			6 DSR	
			7 RTS	circuit
			8 CTS	
				

6 DSR (Of PGU Port): PGU connected.

Driver Version:

Version	Date	Description
V1.02	Dec/30/2008	

SAIA PCD S-BUS Mode

Supported series: SAIA PCD series S-Bus mode.

Website: <http://www.saia-burgess.com/>

HMI Setting:

Parameters	Recommend	Option	Notes
PLC type	SAIA PCD S-BUS Mode		PDS driver
PLC I/F	RS232	RS232, RS485	
Baud rate	9600	9600, 19200, 38400	
Parity	None	Even, Odd, None	
Data bits	8	7,8	
Stop bits	1	1	
PLC st. no.	0	0-255	

PLC Setting:

Communication mode	9600,N,8,1 (default)
RS232	Port 0-Type: RS232
RS485 2W	S-BUS Mode: Data(S2), Port 1-Type: RS485

1. Open Saia Project Manager SP2.0.150 and create a new project.

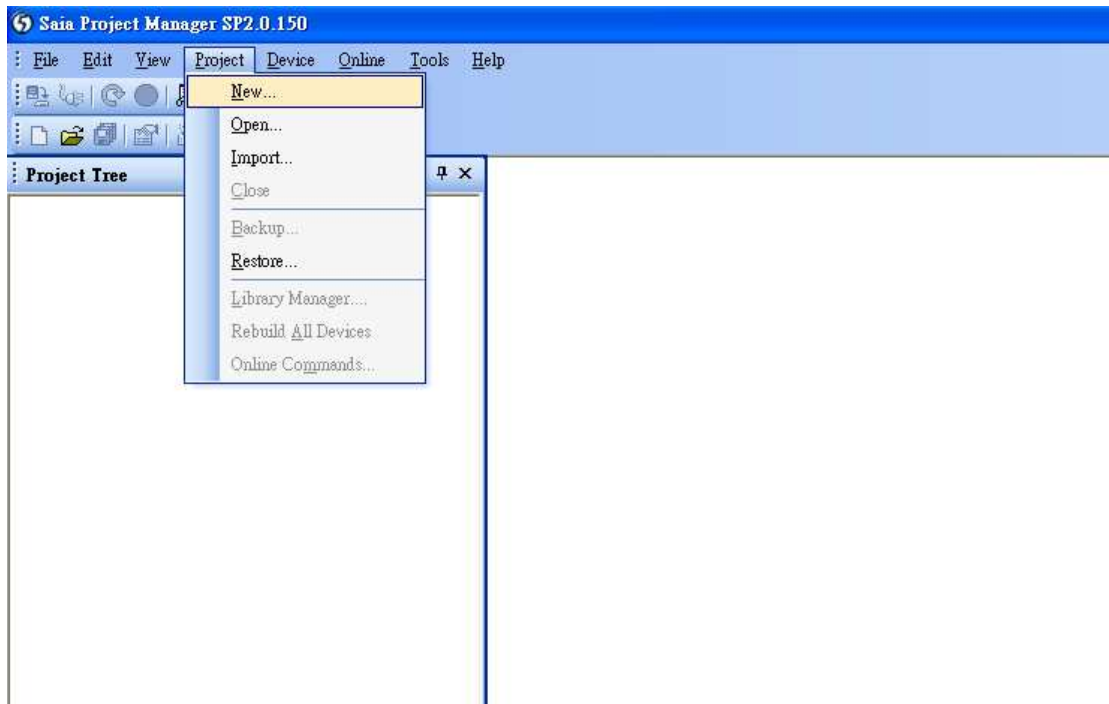

3. Give a project name.

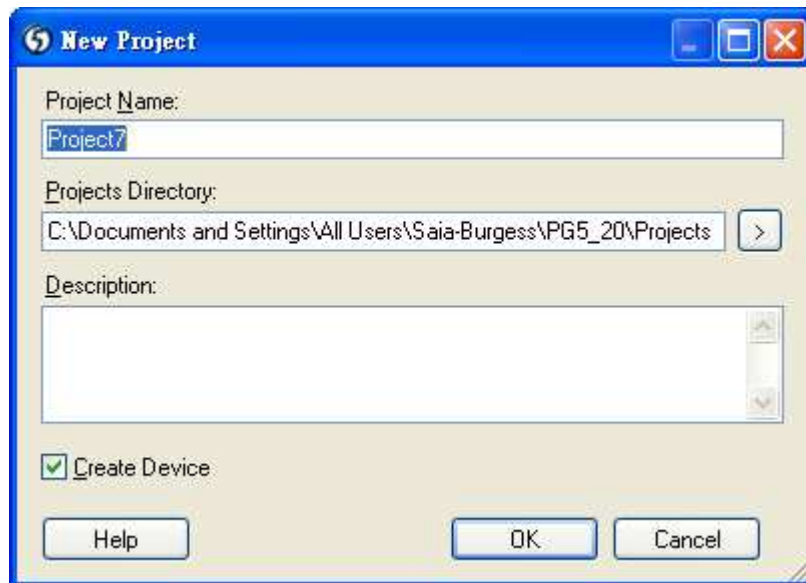

3. Create a new project as below,

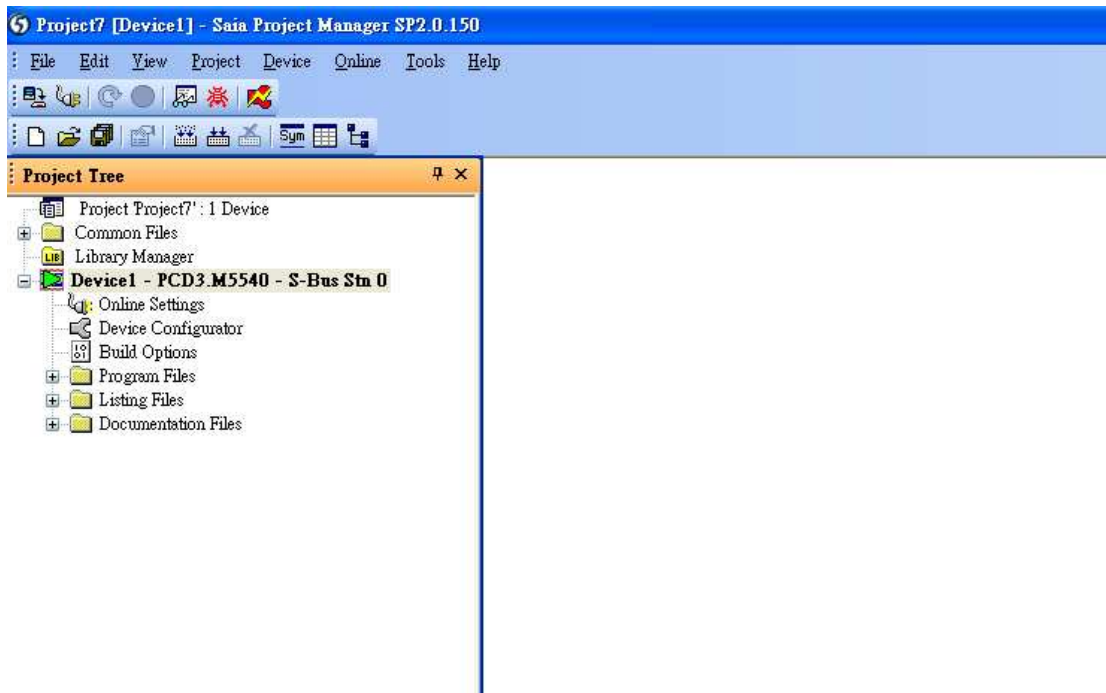

4. Go to Online Setting

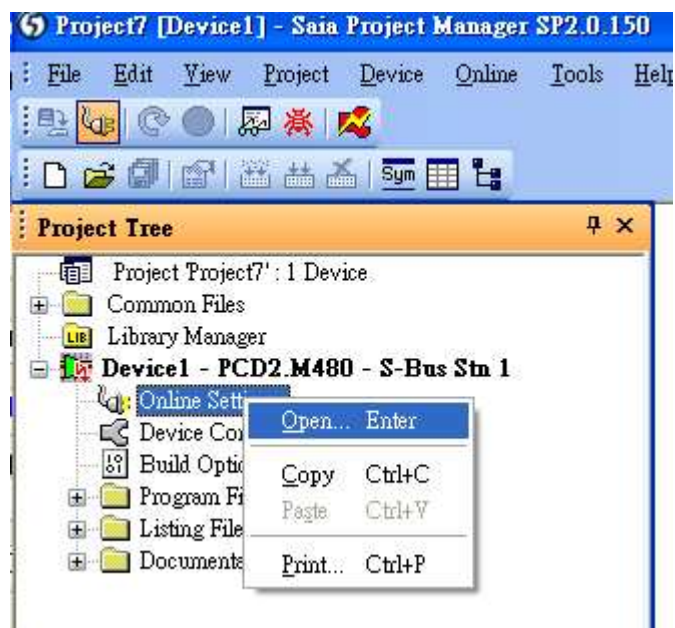

4. Select PGU



6. Go to "Device Configurator"

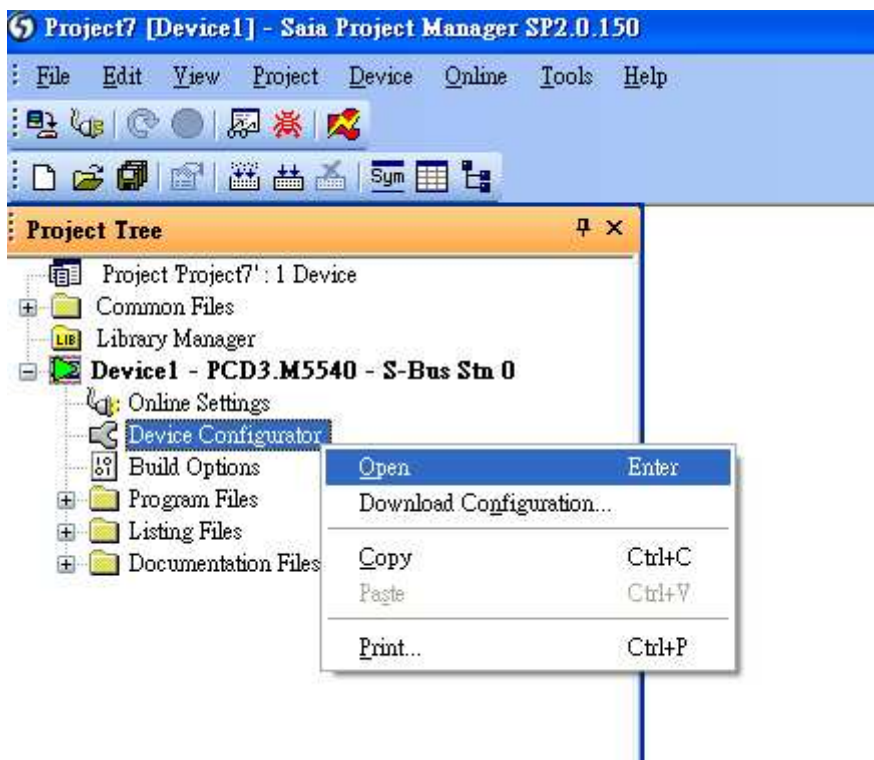

8. Press "Change Device Type" to select your PLC model.

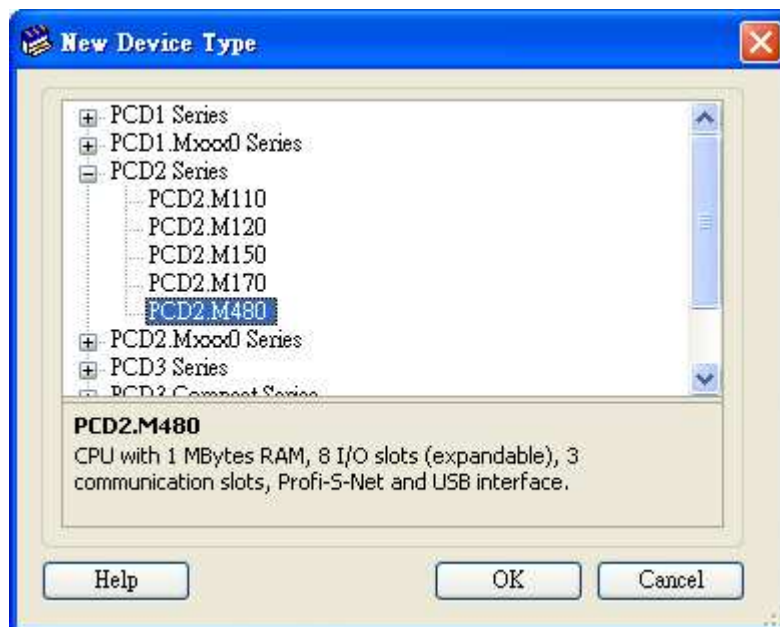
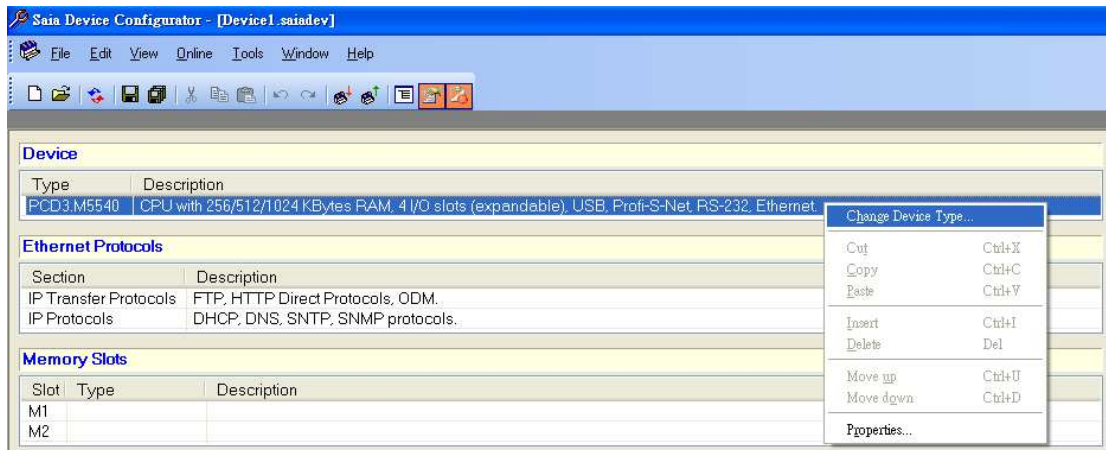

8. Select RS232 (PGU) in Type and then right click mouse on Onboard Communications and select "Properties"

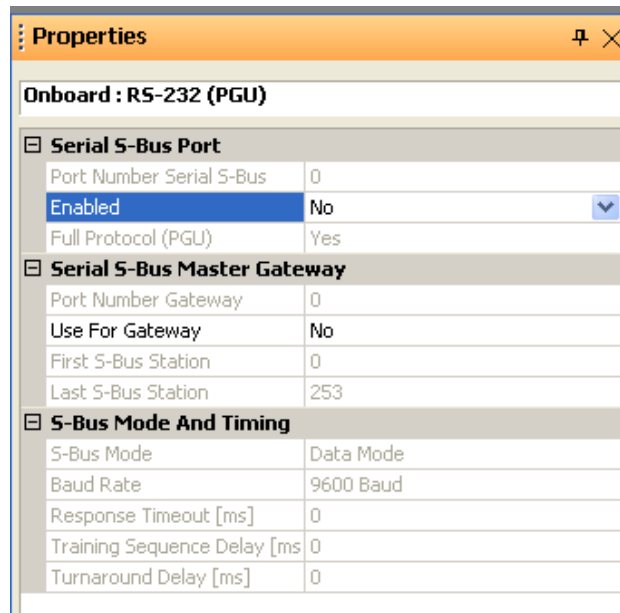

9. Select Yes in Series S-Bus Port: Enabled

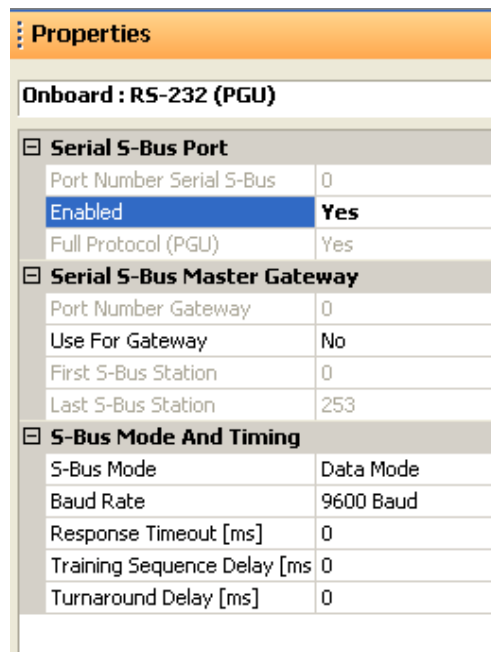

10. Setting parameters in S-Bus Mode and Timing and upload to PLC.

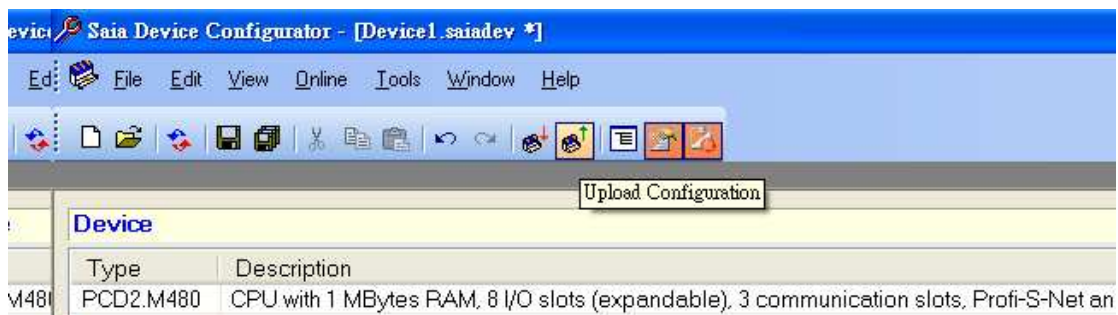

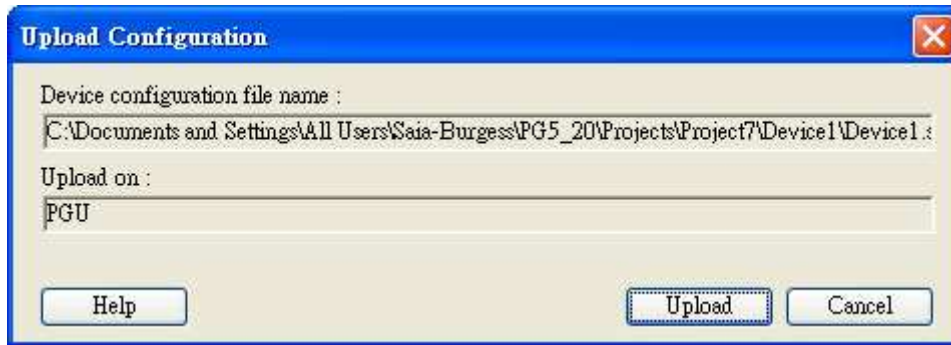

10. Go to Online Settings >> Open to select S-Bus for finishing the PLC settings.

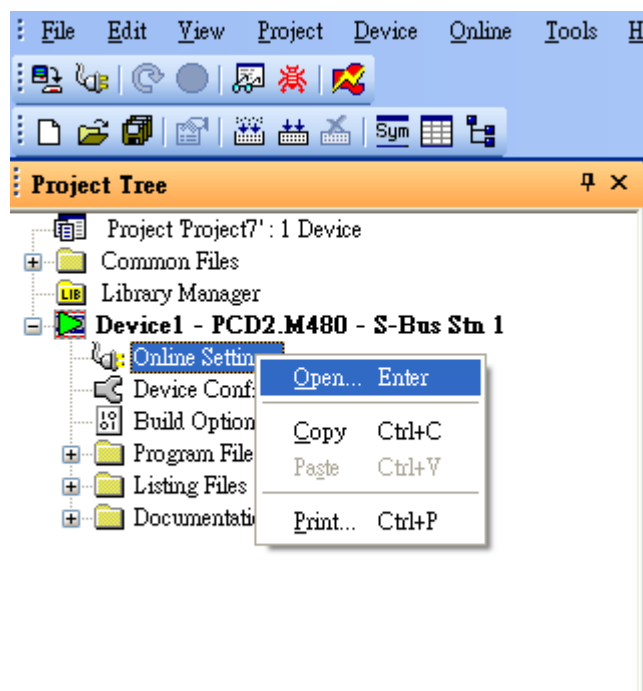

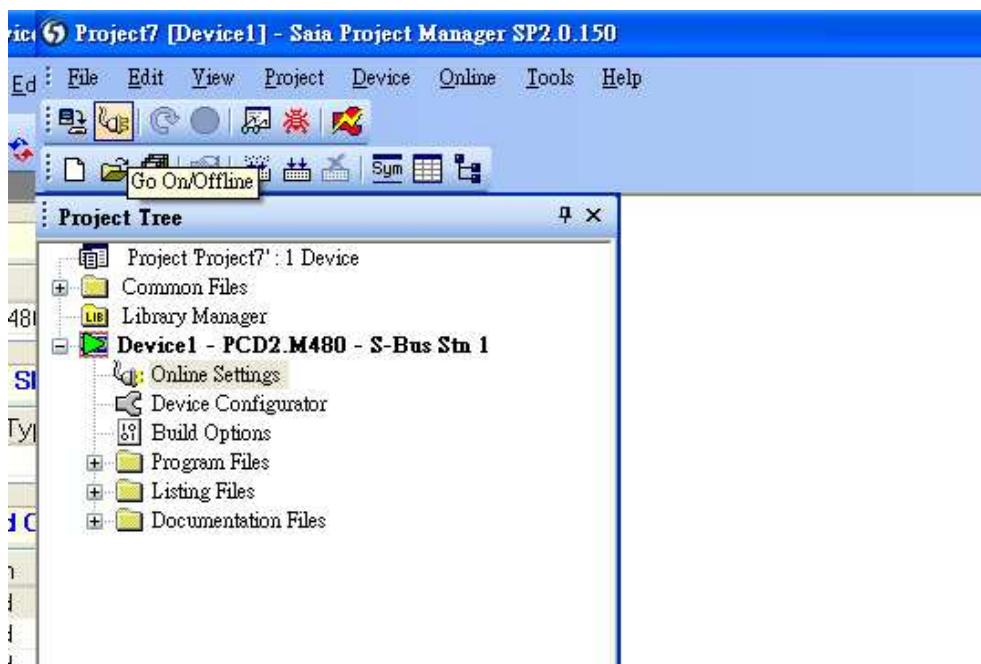
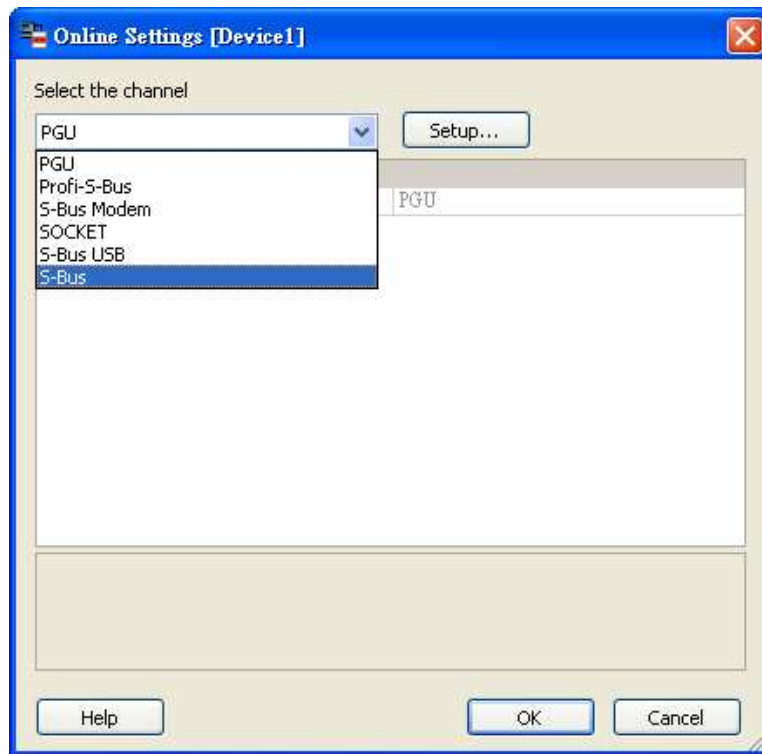

Device Address:

Bit/Word	Device type	Format	Range	Memo
B	Flag	DDDD	0 ~ 8191	
B	Input	DDDD	0 ~ 1023	
B	Output	DDDD	0 ~ 1023	
B	Reg_Bit	DDDDdd	0 ~ 1638331	dd: Bit no. (00~31)
D	Register	DDDDD	0 ~ 16383	
D	Counter	DDDD	0 ~ 1599	
D	Timer	DDDD	0 ~ 1599	
D	Reg_Float	DDDDD	0 ~ 16383	support single float point

Wiring Diagram:

9P D-Sub to 9P D-Sub:

HMI COM1 RS232 9P D-Sub Male	HMI COM2 RS232 9P D-Sub Male	HMI COM3 RS232 9P D-Sub Female	SAIA PCD PGU Port RS232 9P D-Sub	
2 RX	6 RX	8 RX	3 TXD	
3 TX	4 TX	7 TX	2 RXD	
5 GND	5 GND	5 GND	5 GND	
			7 RTS	circuit
			8 CTS	



9P D-Sub to 9P D-Sub:

HMI COM1 RS485 2W 9P D-Sub Female	HMI COM3 RS485 2W 9P D-Sub Female		SAIA PCD1 Port #1 (Port #0)
1 RX-	6 Data-		11 (29)
2 RX+	9 Data+		12 (28)
5 GND	5 GND		



Driver Version:

Version	Date	Description
V1.20	Dec/22/2010	

SAIA S-BUS (Ethernet)

Supported series : SAIA PCD series Ethernet-TCP/IP.

Website : <http://www.saia-burgess.com/>

HMI Setting:

Parameters	Recommend	Option	Notes
PLC type	SAIA S-BUS (Ethernet)		
PLC I/F	Ethernet		
Port no.	5050		
PLC st. no.	0		

PLC Setting:

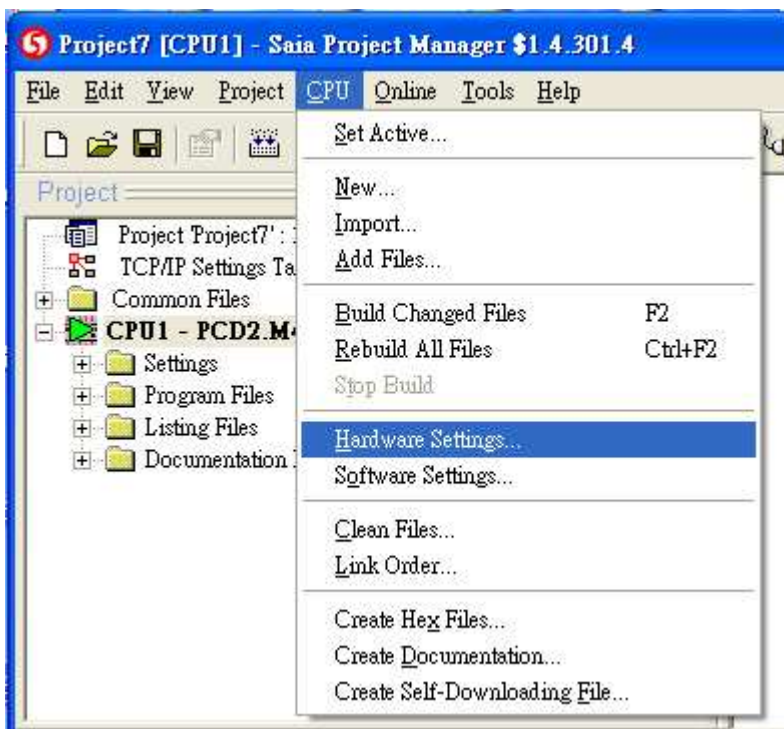

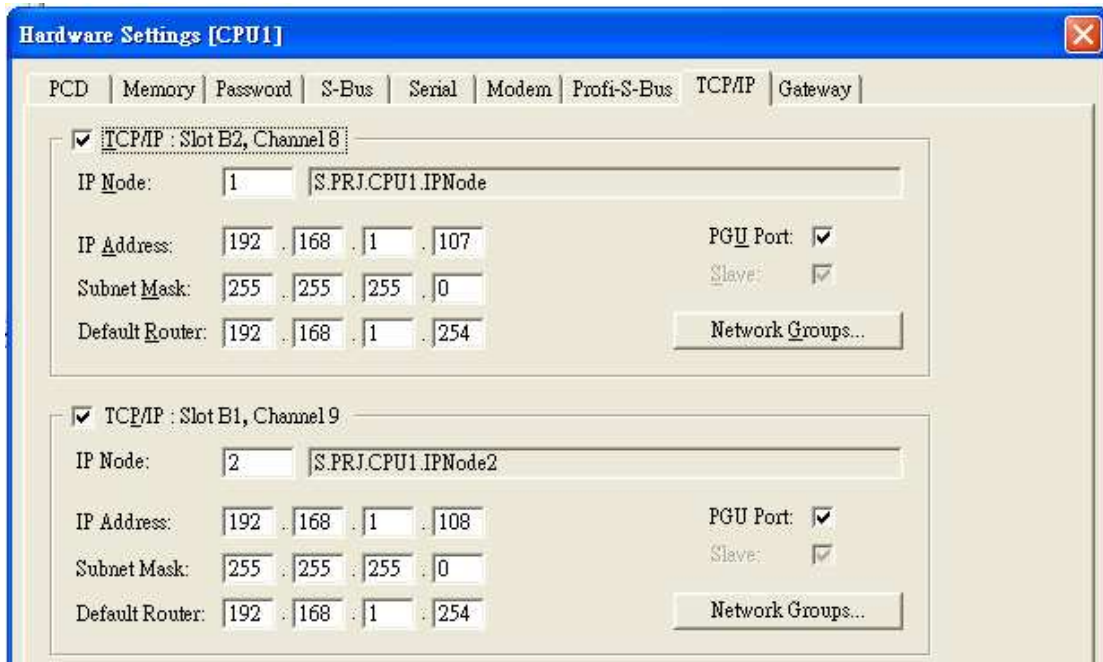

Device Address:

Bit/Word	Device type	Format	Range	Memo
B	Flag	DDDD	0 ~ 8191	
B	Input	DDDD	0 ~ 1023	
B	Output	DDDD	0 ~ 1023	
B	Reg_Bit	DDDDdd	0 ~ 1638331	dd: Bit no. (00~31)
D	Register	DDDDD	0 ~ 16383	
D	Counter	DDDD	0 ~ 1599	
D	Timer	DDDD	0 ~ 1599	
D	Reg_Float	DDDDD	0 ~ 16383	support single float point

Wiring Diagram:

Direct connect (crossover cable):

HMI RJ45 Female	Wire Color	PLC RJ45 Female
1 TX+	White/Orange	3 RX+
2 TX-	Orange	6 RX-
3 RX+	White/Green	1 TX+
4 BD4+	Blue	4 BD4+
5 BD4-	White/Blue	5 BD4-
6 RX-	Green	2 TX-
7 BD3+	White/Brown	7 BD3+
8 BD3-	Brown	8 BD3-



Through a hub:

HMI RJ45 Female	Wire Color	PLC RJ45 Female
1 TX+	White/Orange	1 TX+
2 TX-	Orange	2 TX-
3 RX+	White/Green	3 RX+
4 BD4+	Blue	4 BD4+
5 BD4-	White/Blue	5 BD4-
6 RX-	Green	6 RX-
7 BD3+	White/Brown	7 BD3+
8 BD3-	Brown	8 BD3-



Driver Version:

Version	Date	Description
V1.10	Nov/30/2010	Add Reg_Bit register.

Schleicher XCS 20C

Supported series: Schleicher XCx-Systems Ethernet port. Schleicher XCS series, 20C model.

Website: <http://www.schleicher-electronic.com>

HMI Setting:

Parameters	Recommend	Option	Notes
PLC type	Schleicher XCS 20C		
PLC I/F	RS232		
Baud rate	38400		
Parity	N		
Data bits	8		
Stop bits	1		
PLC st. no.	0		

Device Address:

Bit/Word	Device type	Format	Range	Memo
B	IX	DDDDDo	0 ~ 655357	Input %IX
B	QX	DDDDDo	0 ~ 655357	Output %QX
B	MX	DDDDDo	0 ~ 655357	%MX
W	IW	DDDDD	0 ~ 65535	%IW
W	QW	DDDDD	0 ~ 65535	%QW
W	MW	DDDDD	0 ~ 65535	%MW
DW	ID	DDDDD	0 ~ 65535	%ID
DW	QD	DDDDD	0 ~ 65535	%QD
DW	MD	DDDDD	0 ~ 65535	%WD

- Word address must be even.

Wiring Diagram:

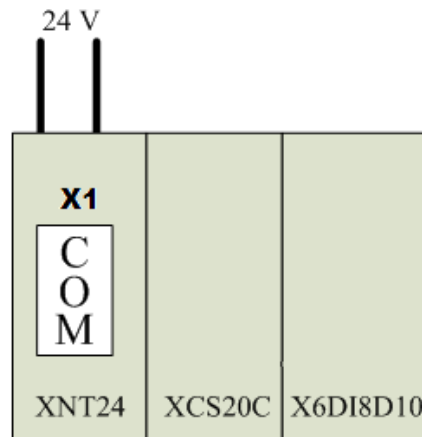

9P D-Sub to 9P D-Sub:

HMI COM1 RS232 9P D-Sub Male	HMI COM2 RS232 9P D-Sub Male	HMI COM3 RS232 9P D-Sub Female	Schleicher XCS20 RS232 9P D-Sub
2 RX	6 RX	8 RX	3 TD
3 TX	4 TX	7 TX	2 RD
5 GND	5 GND	5 GND	5 GND



Driver Version:

Version	Date	Description
V1.10	Feb/26/2010	

Schleicher XCX 300

Website: <http://www.schleicher-electronic.com>

HMI Setting:

Parameters	Recommend	Option	Notes
PLC type	Schleicher XCX 300		
PLC I/F	Ethernet	RS232, RS422, Ethernet	
Port No.	20547		
PLC st. no.	2		

PLC Setting:

Must create variable for HMI access.

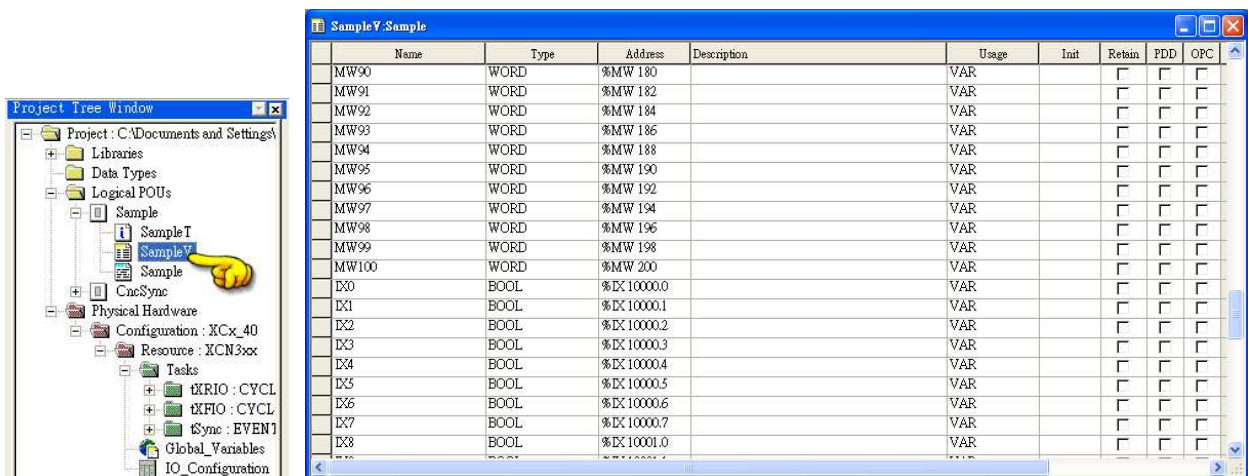

The screenshot shows the SIMATIC Manager interface. On the left is the Project Tree Window, and on the right is the Variable Declaration table for 'Sample Y, Sample'.

Project Tree Window:

- Project: C:\Documents and Settings\...
- Libraries
- Data Types
- Logical POU's
 - Sample
 - Sample I
 - Sample Y** (highlighted with a yellow hand cursor)
 - Sample
 - CncSync
- Physical Hardware
 - Configuration: XCX_40
 - Resource: XCN3xxx
 - Tasks
 - IRIO : CYCL
 - IFIO : CYCL
 - iSync : EVEN1
 - Global_Variables
 - IO_Configuration

Variable Declaration Table:

Name	Type	Address	Description	Usage	Init	Retain	PDD	OPC
MW90	WORD	%MW 180		VAR		<input type="checkbox"/>	<input type="checkbox"/>	<input type="checkbox"/>
MW91	WORD	%MW 182		VAR		<input type="checkbox"/>	<input type="checkbox"/>	<input type="checkbox"/>
MW92	WORD	%MW 184		VAR		<input type="checkbox"/>	<input type="checkbox"/>	<input type="checkbox"/>
MW93	WORD	%MW 186		VAR		<input type="checkbox"/>	<input type="checkbox"/>	<input type="checkbox"/>
MW94	WORD	%MW 188		VAR		<input type="checkbox"/>	<input type="checkbox"/>	<input type="checkbox"/>
MW95	WORD	%MW 190		VAR		<input type="checkbox"/>	<input type="checkbox"/>	<input type="checkbox"/>
MW96	WORD	%MW 192		VAR		<input type="checkbox"/>	<input type="checkbox"/>	<input type="checkbox"/>
MW97	WORD	%MW 194		VAR		<input type="checkbox"/>	<input type="checkbox"/>	<input type="checkbox"/>
MW98	WORD	%MW 196		VAR		<input type="checkbox"/>	<input type="checkbox"/>	<input type="checkbox"/>
MW99	WORD	%MW 198		VAR		<input type="checkbox"/>	<input type="checkbox"/>	<input type="checkbox"/>
MW100	WORD	%MW 200		VAR		<input type="checkbox"/>	<input type="checkbox"/>	<input type="checkbox"/>
IX0	BOOL	%IX 10000.0		VAR		<input type="checkbox"/>	<input type="checkbox"/>	<input type="checkbox"/>
IX1	BOOL	%IX 10000.1		VAR		<input type="checkbox"/>	<input type="checkbox"/>	<input type="checkbox"/>
IX2	BOOL	%IX 10000.2		VAR		<input type="checkbox"/>	<input type="checkbox"/>	<input type="checkbox"/>
IX3	BOOL	%IX 10000.3		VAR		<input type="checkbox"/>	<input type="checkbox"/>	<input type="checkbox"/>
IX4	BOOL	%IX 10000.4		VAR		<input type="checkbox"/>	<input type="checkbox"/>	<input type="checkbox"/>
IX5	BOOL	%IX 10000.5		VAR		<input type="checkbox"/>	<input type="checkbox"/>	<input type="checkbox"/>
IX6	BOOL	%IX 10000.6		VAR		<input type="checkbox"/>	<input type="checkbox"/>	<input type="checkbox"/>
IX7	BOOL	%IX 10000.7		VAR		<input type="checkbox"/>	<input type="checkbox"/>	<input type="checkbox"/>
IX8	BOOL	%IX 10001.0		VAR		<input type="checkbox"/>	<input type="checkbox"/>	<input type="checkbox"/>

Device Address:

Bit/Word	Device type	Format	Range	Memo
B	IX	DDDDDo	0 ~ 655357	Input %IX
B	QX	DDDDDo	0 ~ 655357	Output %QX
B	MX	DDDDDo	0 ~ 655357	%MX
W	IW	DDDDD	0 ~ 65535	%IW
W	QW	DDDDD	0 ~ 65535	%QW
W	MW	DDDDD	0 ~ 65535	%MW
DW	ID	DDDDD	0 ~ 65535	%ID

DW	QD	DDDDD	0 ~ 65535	%QD
DW	MD	DDDDD	0 ~ 65535	%WD

- Word address must be even.

Wiring Diagram:

Direct connect (crossover cable):

HMI RJ45 Female	Wire Color	PLC RJ45 Female
1 TX+	White/Orange	3 RX+
2 TX-	Orange	6 RX-
3 RX+	White/Green	1 TX+
4 BD4+	Blue	4 BD4+
5 BD4-	White/Blue	5 BD4-
6 RX-	Green	2 TX-
7 BD3+	White/Brown	7 BD3+
8 BD3-	Brown	8 BD3-



Through a hub:

HMI RJ45 Female	Wire Color	PLC RJ45 Female
1 TX+	White/Orange	1 TX+
2 TX-	Orange	2 TX-
3 RX+	White/Green	3 RX+
4 BD4+	Blue	4 BD4+
5 BD4-	White/Blue	5 BD4-
6 RX-	Green	6 RX-
7 BD3+	White/Brown	7 BD3+
8 BD3-	Brown	8 BD3-



9P D-Sub to 9P D-Sub:

HMI COM1 RS232 9P D-Sub Male	HMI COM2 RS232 9P D-Sub Male	HMI COM3 RS232 9P D-Sub Female	Schleicher XCX300 RS232 Port
2 RX	6 RX	8 RX	TXD
3 TX	4 TX	7 TX	RXD
5 GND	5 GND	5 GND	GND

9P D-Sub to 9P D-Sub:

HMI COM1 RS485 4W 9P D-Sub Female			Schleicher XCX300 RS422 Port
1 RX-			TX-
2 RX+			TX+
3 TX-			RX-
4 TX+			RX+
5 GND			GND

Driver Version:

Version	Date	Description
V1.00	Nov/30/2009	Driver released.
V1.10	Jun/28/2010	Support RS232, RS422 interface connection.

SEW Movilink

Supported series: SEW Eurodrive series, model MOVITRAC-07 inverter, MovitracB.

Website: <http://sg.sew-eurodrive.com/>

HMI Setting:

Parameters	Recommend	Option	Notes
PLC type	SEW Movilink		
PLC I/F	RS485 2W		
Baud rate	9600		
Data bits	8		
Parity	Even		
Stop bits	1		
PLC st. no.	0	0~255	

Device Address:

Bit/Word	Device type	Format	Range	Memo
W	INDEX	DDDDDDDD	0 ~ 25525000	
B	INDEX_Bit	DDDDDDDDdd	0 ~ 2552500031	

- The MOVITRAC-07 doesn't support Sub index (other series maybe support) , please fixed to input 000.
- When input D and d, the correct format example as follow : Sub index 15, Index 8359, Format is 01508359.

Wiring Diagram:

9P D-Sub to 4P:

HMI COM1 RS485 2W 9P D-Sub Female	HMI COM3 RS485 2W 9P D-Sub Female		Movitrac-07 RS485
1 RX-	6 Data-		D- (Green)
2 RX+	9 Data+		D+ (Red)

5 GND	5 GND		
			

Driver Version:

Version	Date	Description
V1.31	Jun/25/2010	

SIEMENS S7/1200 (Ethernet)

Supported series: Siemens S7/1200 series Ethernet.

Website: <http://www.ad.siemens.com>

HMI Setting:

Parameters	Recommend	Option	Notes
PLC type	SIEMENS S7/1200 (Ethernet)		
PLC I/F	Ethernet		
PLC st. no.	2		
Port no.	102		
Interval of block pack	0		

1. In S7-1200 program software creates PLC program and tag and then download to PLC.
2. Select Go offline, EasyBuilder will connect to PLC and get tag data. In PLC type select "SIEMENS S7/1200 (Ethernet)". Set Interval of block pack (words) to 0.

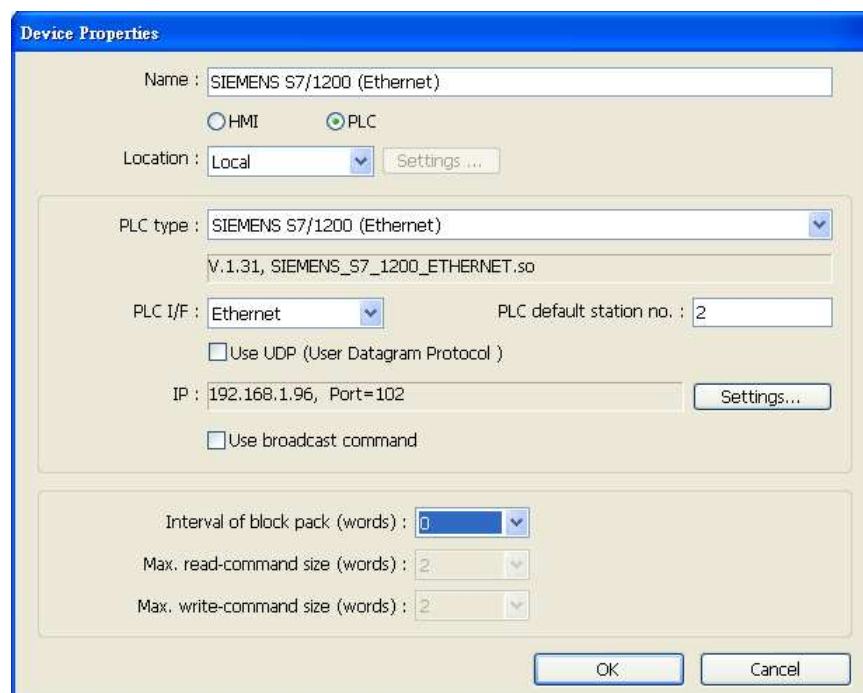

- Click “Settings...”, input PLC IP address.

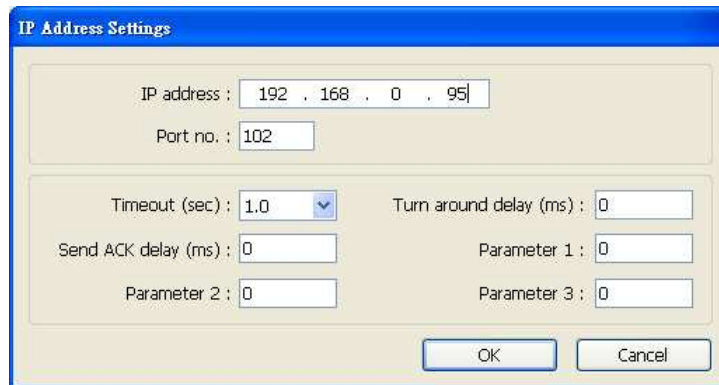

The IP Address Settings dialog box contains the following fields:

- IP address: 192 . 168 . 0 . 95
- Port no.: 102
- Timeout (sec): 1.0 (dropdown menu)
- Turn around delay (ms): 0
- Send ACK delay (ms): 0
- Parameter 1: 0
- Parameter 2: 0
- Parameter 3: 0

Buttons: OK, Cancel

- Check the PLC has not any PC connected. Click “Get tag info...”, it will show a successful message.

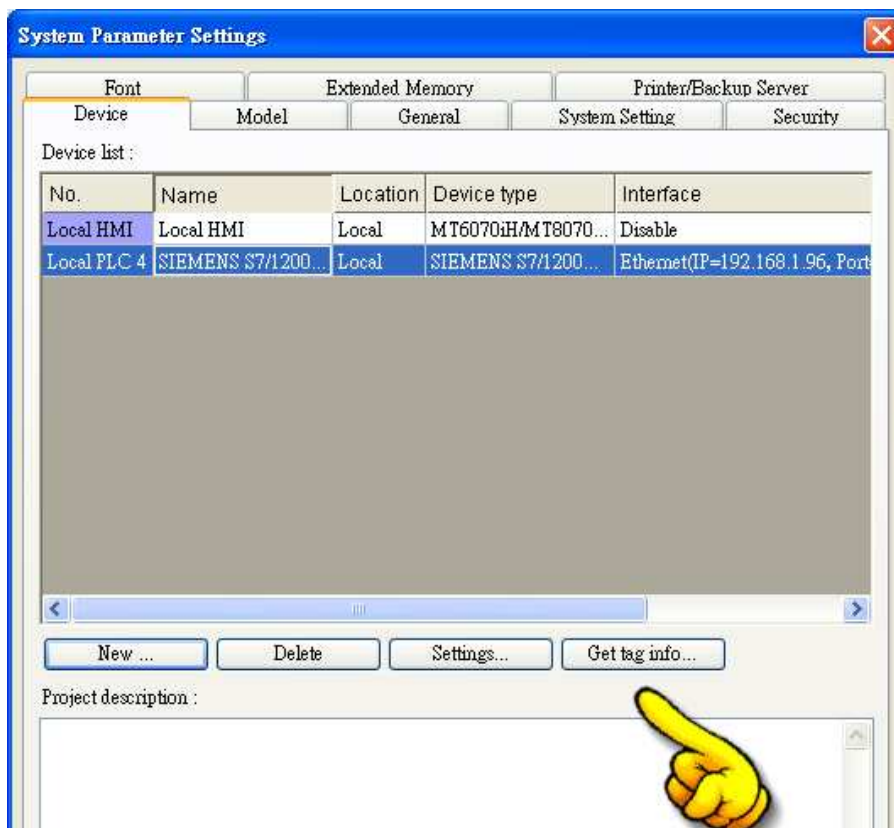

The System Parameter Settings dialog box shows the following tabs and sections:

- Tabs: Font, Extended Memory, Printer/Backup Server
- Sub-tabs: Device, Model, General, System Setting, Security
- Device list table:

No.	Name	Location	Device type	Interface
Local HMI	Local HMI	Local	MT6070:H/MT8070...	Disable
Local PLC 4	SIEMENS S7/1200...	Local	SIEMENS S7/1200...	Ethernet(IP=192.168.1.96, Port

Buttons: New ..., Delete, Settings..., Get tag info...

Project description:

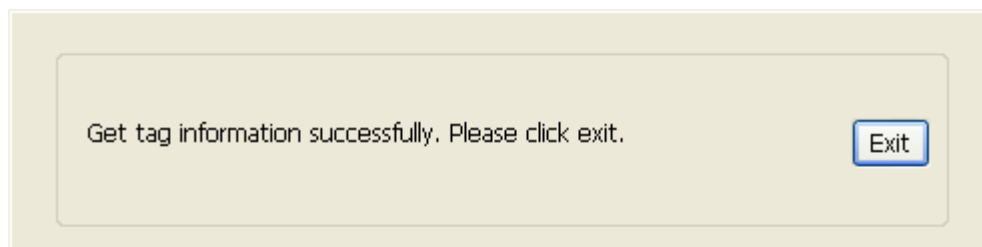

Get tag information successfully. Please click exit.

Exit

5. Create an object and click read address “Setting...”



In PLC name select S7-1200 then click Tag.

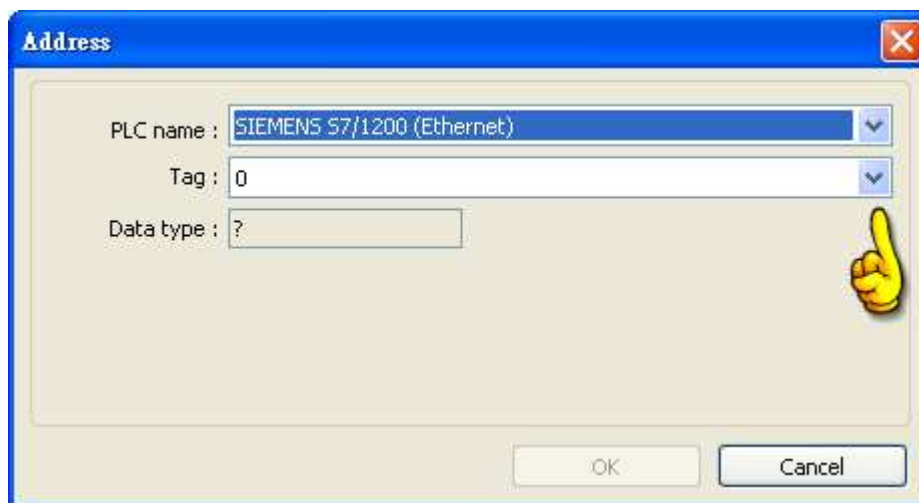

Select PLC tag.

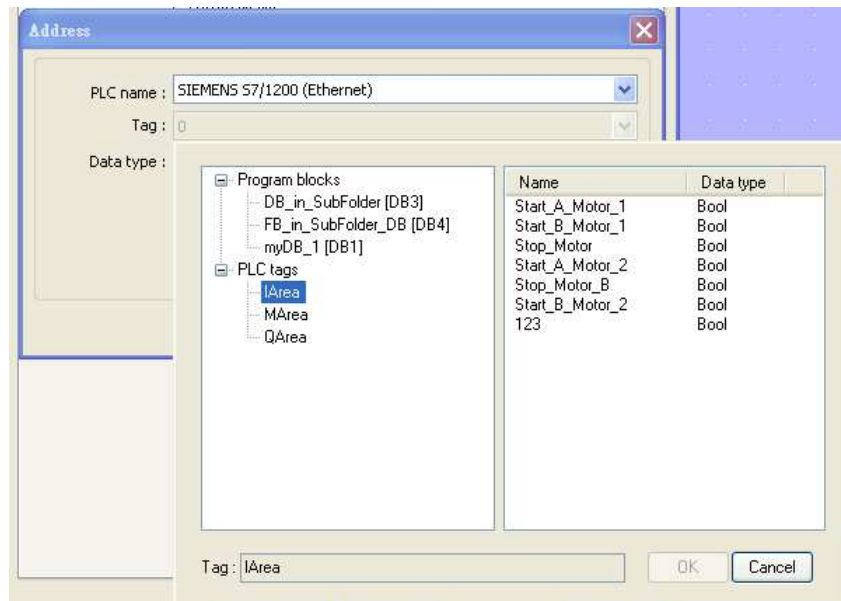

Support Device Type:

S7-1200 data type	EasyBuilder data format	Memo
Bool	bit	
Word	16-bit BCD, Hex, Binary, Unsigned	
Int	16-bit BCD, Hex, Binary, Signed	
DWord	32-bit BCD, Hex, Binary, Unsigned	
Dint	32-bit BCD, Hex, Binary, Signed	
Real	32-bit Float	
Array	Word array for ASCII input and ASCII display	Length=word

Note:

On-line Simulation	OK	Multi-PLC connect	OK
--------------------	----	-------------------	----

Wiring Diagram:

Direct connect (crossover cable):

HMI RJ45 Female	Wire Color	PLC RJ45 Female
1 TX+	White/Orange	3 RX+
2 TX-	Orange	6 RX-
3 RX+	White/Green	1 TX+
4 BD4+	Blue	4 BD4+
5 BD4-	White/Blue	5 BD4-
6 RX-	Green	2 TX-
7 BD3+	White/Brown	7 BD3+
8 BD3-	Brown	8 BD3-



Through a hub:

HMI RJ45 Female	Wire Color	PLC RJ45 Female
1 TX+	White/Orange	1 TX+
2 TX-	Orange	2 TX-
3 RX+	White/Green	3 RX+
4 BD4+	Blue	4 BD4+
5 BD4-	White/Blue	5 BD4-
6 RX-	Green	6 RX-
7 BD3+	White/Brown	7 BD3+
8 BD3-	Brown	8 BD3-



Driver Version:

Version	Date	Description
V1.70	Sep/24/2010	

SIEMENS S7/200

Supported series: Siemens S7/200 series PLC
(CPU212/214/215/216/221/222/224/226/226XM)

Website: <http://www.ad.siemens.com>

HMI Setting:

Parameters	Recommend	Option	Notes
PLC type	SIEMENS S7/200		
PLC I/F	RS485 2w	RS485 2w	
Baud rate	9600	9600, 19200, 187.5K	The HMIs which has sticker MPI187.5 on the rear panel, support 187.5 baud rate.
Parity	Even	Even, Odd, None	
Data bits	8	7,8	
Stop bits	1	1, 2	
PLC st. no.	2		
Turn around delay (ms)	5		
Reserved 1	30		ACK delay time

Online Simulator	YES	Extend address mode	NO
Broadcast command	NO		

PLC Setting:

Communication mode	Set station number as 2
--------------------	-------------------------

Device Address:

Bit/Word	Device type	Format	Range	Memo
B	I	DDDDo	0 ~ 40957	Input (I)
B	Q	DDDDo	0 ~ 40957	Output (O)
B	M	DDDDo	0 ~ 40957	Bit Memory
B	VW.Bit	DDDDDo	0 ~ 102397	V Memory bit address
W	VB	DDDDD	0 ~ 10239	

W	VW	DDDDD	0 ~ 10239	V memory
W	VW_Odd	DDDDD	0 ~ 10239	V memory
DW	VD	DDDDD	0 ~ 10239	V memory double word
DW	VD_Odd	DDDDD	0 ~ 10239	V memory double word
W	VD_String	DDDDD	0 ~ 10239	String
W	VD_String_Odd	DDDDD	0 ~ 10239	String
W	VW_String	DDDDD	0 ~ 10239	String
W	VW_String_Odd	DDDDD	0 ~ 10239	String
W	MB	DDDDD	0 ~ 10239	byte memory
W	MW	DDDDD	0 ~ 10239	Word memory
W	MW_Odd	DDDDD	0 ~ 10239	Word memory
W	T	DDD	0 ~ 127	Timer
W	C	DDD	0 ~ 127	Counter

- Double word and Floating point value must use VD device type.

Wiring Diagram:

9P D-Sub to 9P D-Sub:

HMI COM1 RS485 2W 9P D-Sub Female	HMI COM3 RS485 2W 9P D-Sub Female		Siemens S7-200 CPU Port RS485 2W 9P D-Sub
1 RX-	6 Data-		8 D-
2 RX+	9 Data+		3 D+
5 GND	5 GND		5 GND



Driver Version:

Version	Date	Description
V2.30	Aug/17/2009	

SIEMENS S7/200 (Ethernet)

Supported series: Siemens S7/200 Ethernet Series PLC
(CPU212/214/215/216/221/222/224/226/226XM)

Website: <http://www.ad.siemens.com>

HMI Setting:

Parameters	Recommend	Option	Notes
PLC type	Siemens S7/200 (Ethernet)		
PLC I/F	Ethernet		
Port no.	102		
PLC st. no.	1	0-31	

Device Address:

Bit/Word	Device type	Format	Range	Memo
B	I	DDDDo	0 ~ 40957	Input (I)
B	Q	DDDDo	0 ~ 40957	Output (O)
B	M	DDDDo	0 ~ 40957	Bit Memory
B	VW_Bit	DDDDo	0 ~ 40957	V Memory bit address
W	VW	DDDDD	0 ~ 10239	V memory
W	VW_String	DDDDD	0 ~ 10239	String
DW	VD	DDDDD	0 ~ 10239	V memory double word
DW	VD_String	DDDDD	0 ~ 10239	String

- Double word and Floating point value must use VD device type.

Wiring Diagram:

Direct connect (crossover cable):

HMI RJ45 Female	Wire Color	PLC RJ45 Female
1 TX+	White/Orange	3 RX+
2 TX-	Orange	6 RX-
3 RX+	White/Green	1 TX+
4 BD4+	Blue	4 BD4+
5 BD4-	White/Blue	5 BD4-
6 RX-	Green	2 TX-
7 BD3+	White/Brown	7 BD3+
8 BD3-	Brown	8 BD3-



Through a hub:

HMI RJ45 Female	Wire Color	PLC RJ45 Female
1 TX+	White/Orange	1 TX+
2 TX-	Orange	2 TX-
3 RX+	White/Green	3 RX+
4 BD4+	Blue	4 BD4+
5 BD4-	White/Blue	5 BD4-
6 RX-	Green	6 RX-
7 BD3+	White/Brown	7 BD3+
8 BD3-	Brown	8 BD3-



Driver Version:

Version	Date	Description
V1.20	Dec/30/2008	

SIEMENS S7/300

Supported series: Siemens S7/300 series PLC

Website: <http://www.ad.siemens.com>

HMI Setting:

Parameters	Recommend	Option	Notes
PLC type	SIEMENS S7/300		
PLC I/F	RS232		
Baud rate	19200, 38400, 187.5K	9600~187.5K	Must same as the PLC setting The HMIs which has sticker MPI187.5 on the rear panel, support 187.5 baud rate.
Parity	Odd		
Data bits	8		
Stop bits	1		
PLC st. no.	2		Must same as the PLC setting

Device Address:

Bit/Word	Device type	Format	Range	Memo
B	I	DDDDo	0 ~ 40957	Input (I)
B	Q	DDDDo	0 ~ 40957	Output (O)
B	M	DDDDo	0 ~ 40957	Bit Memory
B	DBnBit	FFFFDDDDo	0 ~ 409681927	Data register bit
B	DB0Bit ~ DB99Bit	DDDDo	0 ~ 81927	
W	IW	DDDD	0 ~ 4095	Input (I)
W	QW	DDDD	0 ~ 4095	Output (O)
W	MW	DDDD	0 ~ 4095	Bit Memory
W	MD	DDDD	0 ~ 4094	
W	DB0-DB99	DDDD	0 ~ 8192	Data register(must be even)
W	DBn	FFFFDDDD	0 ~ 40968192	Data register(must be even)

DW	DBDn	FFFFDDDD	0 ~ 40968192	Data register double word (must be multiple of 4)
DW	DBn_String	FFFFDDDD	0 ~ 40968192	Data register double word (must be multiple of 4)
DW	DBDn_String	FFFFDDDD	0 ~ 40968192	Data register double word (must be multiple of 4)

* Double word and Floating point value must use DBDn device type.

Wiring Diagram:

9P D-Sub to 9P D-Sub:

HMI COM1 RS232 9P D-Sub Male	HMI COM2 RS232 9P D-Sub Male	HMI COM3 RS232 9P D-Sub Female	Siemens S7-300 PC Adapter RS232 Port 9P D-Sub	
2 RX	6 RX	8 RX	3 TXD	
3 TX	4 TX	7 TX	2 RXD	
5 GND	5 GND	5 GND	5 GND	
			7 RTS	circuit
			8 CTS	
				

9P D-Sub to 9P D-Sub:

HMI COM1 RS232 9P D-Sub Male	HMI COM2 RS232 9P D-Sub Male	HMI COM3 RS232 9P D-Sub Female	Systeme Helmholz SSW7-TS RS232 9P D-Sub	
2 RX	6 RX	8 RX	3 TXD	
3 TX	4 TX	7 TX	2 RXD	
5 GND	5 GND	5 GND	5 GND	
			7 RTS	circuit
			8 CTS	
			4 DTR	circuit
			6 DSR	

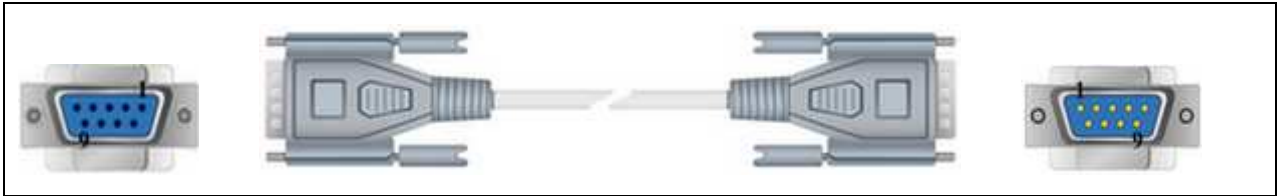

Driver Version:

Version	Date	Description
V2.80	Dec/07/2010	

SIEMENS S7/300 (Ethernet)

Supported series: Siemens S7/300 Ethernet Series PLC.

Website: <http://www.ad.siemens.com>

HMI Setting:

Parameters	Recommend	Option	Notes
PLC type	Siemens S7/300 (Ethernet)		
PLC I/F	Ethernet		
Port no.	102		
PLC st. no.	1	0-31	

Device Address:

Bit/Word	Device type	Format	Range	Memo
B	I	DDDDo	0 ~ 40957	Input (I)
B	Q	DDDDo	0 ~ 40957	Output (O)
B	M	DDDDo	0 ~ 40957	Bit Memory
B	DBnBit	FFFFDDDDo	0 ~ 4096655327	
B	DB0Bit-DB99Bit	DDDDDo	0 ~ 655327	Data register bit
W	IW	DDDD	0 ~ 4095	Input (I)
W	QW	DDDD	0 ~ 4095	Output (O)
W	MW	DDDD	0 ~ 4095	Bit Memory
W	MD	DDDD	0 ~ 4094	
W	DBn	FFFFDDDD	0 ~ 40968192	Data register(must be even)
DW	DBDn	FFFFDDDD	0 ~ 40968192	Data register double word (must be multiple of 4)
DW	DBn_String	FFFFDDDD	0 ~ 40968192	
DW	DBDn_String	FFFFDDDD	0 ~ 40968192	
W	DB0 ~ DB99	DDDD	0 ~ 65532	Data register(must be even)

- Double word and Floating point value must use DBDn device type.

Wiring Diagram:

Direct connect (crossover cable):

HMI RJ45 Female	Wire Color	PLC RJ45 Female
1 TX+	White/Orange	3 RX+
2 TX-	Orange	6 RX-
3 RX+	White/Green	1 TX+
4 BD4+	Blue	4 BD4+
5 BD4-	White/Blue	5 BD4-
6 RX-	Green	2 TX-
7 BD3+	White/Brown	7 BD3+
8 BD3-	Brown	8 BD3-



Through a hub:

HMI RJ45 Female	Wire Color	PLC RJ45 Female
1 TX+	White/Orange	1 TX+
2 TX-	Orange	2 TX-
3 RX+	White/Green	3 RX+
4 BD4+	Blue	4 BD4+
5 BD4-	White/Blue	5 BD4-
6 RX-	Green	6 RX-
7 BD3+	White/Brown	7 BD3+
8 BD3-	Brown	8 BD3-



Driver Version:

Version	Date	Description
V1.90	Dec/07/2010	

SIEMENS S7/300 MPI

Supported series: Siemens S7/300 series PLC.

Website: <http://www.ad.siemens.com>

HMI Setting:

Parameters	Recommend	Option	Notes
PLC type	SIEMENS S7/300 MPI		
PLC I/F	RS485 2W		
Baud rate	187.5K		
Parity	Even		
Data bits	8		
Stop bits	1		
PLC st. no.	2		

Device Address:

Bit/Word	Device type	Format	Range	Memo
B	I	DDDDo	0 ~ 40957	Input (I)
B	Q	DDDDo	0 ~ 40957	Output (O)
B	M	DDDDo	0 ~ 40957	Bit Memory
B	DBnBit	FFFFDDDDo	0 ~ 409681927	
B	DB0Bit-DB99Bit	DDDDDo	0 ~ 655327	Data register bit
W	IW	DDDD	0 ~ 4095	Input (I)
W	QW	DDDD	0 ~ 4095	Output (O)
W	MW	DDDD	0 ~ 4095	Bit Memory
W	MD	DDDD	0 ~ 4094	
W	DBn	FFFFDDDD	0 ~ 40968192	Data register(must be even)
DW	DBDn	FFFFDDDD	0 ~ 40968192	Data register double word (must be multiple of 4)
DW	DBn_String	FFFFDDDD	0 ~ 40968192	
DW	DBDn_String	FFFFDDDD	0 ~ 40968192	
W	DB0 ~ DB99	DDDD	0 ~ 65532	Data register(must be

				even)
--	--	--	--	-------

* Double word and Floating point value must use DBDn device type.

Wiring Diagram:

9P D-Sub to 9P D-Sub:

HMI COM1 RS485 2W 9P D-Sub Female	HMI COM3 RS485 2W 9P D-Sub Female		S7-200 PPI RS485 2W 9P D-Sub S7-300 MPI RS485 2W 9P D-Sub
1 RX-	6 Data-		8 D-
2 RX+	9 Data+		3 D+
5 GND	5 GND		5 GND



Driver Version:

Version	Date	Description
V1.50	Dec/07/2010	

SIEMENS S7/400 (Ethernet)

Supported series: Siemens S7/400 Ethernet PLC.

Website: <http://www.ad.siemens.com>

HMI Setting:

Parameters	Recommend	Option	Notes
PLC type	Siemens S7/400 (Ethernet)		
PLC I/F	Ethernet		
Port no.	102		
PLC st. no.	0	0-31	
Link type	PG	PC, OP	
Rack	0	0-7	
CPU slot	3	2-31	

Device Address:

Bit/Word	Device type	Format	Range	Memo
B	I	DDDDo	0 ~ 40957	Input (I)
B	Q	DDDDo	0 ~ 40957	Output (O)
B	M	DDDDo	0 ~ 40957	Bit Memory
B	DBnBit	FFFFDDDDo	0 ~ 4096655327	
B	DB0Bit-DB99Bit	DDDDDo	0 ~ 655327	Data register bit
W	IW	DDDD	0 ~ 4095	Input (I)
W	QW	DDDD	0 ~ 4095	Output (O)
W	MW	DDDD	0 ~ 4095	Bit Memory
W	MD	DDDD	0 ~ 4094	
W	DBn	FFFFDDDD	0 ~ 40968192	Data register(must be even)
DW	DBDn	FFFFDDDD	0 ~ 40968192	Data register double word (must be multiple of 4)
DW	DBn_String	FFFFDDDD	0 ~ 40968192	
DW	DBDn_String	FFFFDDDD	0 ~ 40968192	
W	DB0 ~ DB99	DDDD	0 ~ 65532	Data register(must

				be even)
--	--	--	--	----------

* Double word and Floating point value must use DBDn device type.

Wiring Diagram:

Direct connect (crossover cable):

HMI RJ45 Female	Wire Color	PLC RJ45 Female
1 TX+	White/Orange	3 RX+
2 TX-	Orange	6 RX-
3 RX+	White/Green	1 TX+
4 BD4+	Blue	4 BD4+
5 BD4-	White/Blue	5 BD4-
6 RX-	Green	2 TX-
7 BD3+	White/Brown	7 BD3+
8 BD3-	Brown	8 BD3-



Through a hub:

HMI RJ45 Female	Wire Color	PLC RJ45 Female
1 TX+	White/Orange	1 TX+
2 TX-	Orange	2 TX-
3 RX+	White/Green	3 RX+
4 BD4+	Blue	4 BD4+
5 BD4-	White/Blue	5 BD4-
6 RX-	Green	6 RX-
7 BD3+	White/Brown	7 BD3+
8 BD3-	Brown	8 BD3-



EasyBuilder Device Setting Steps

1. Open EasyBuilder, and File -> NEW, select HMI model and press ok button

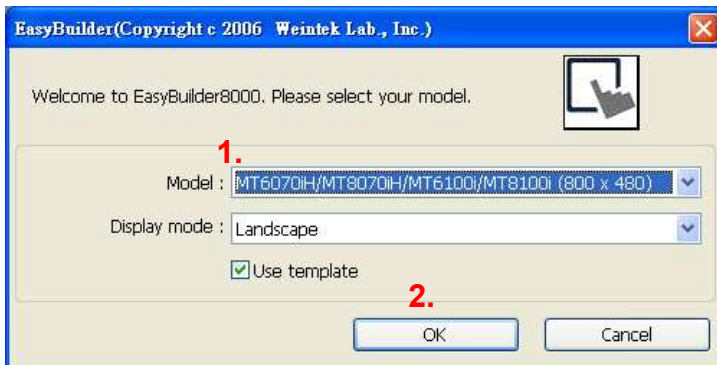

2. Then, you will see the window of "system parameter settings", press "New" button.
3. Select "SIEMENS S7/400(ETHERNET)".

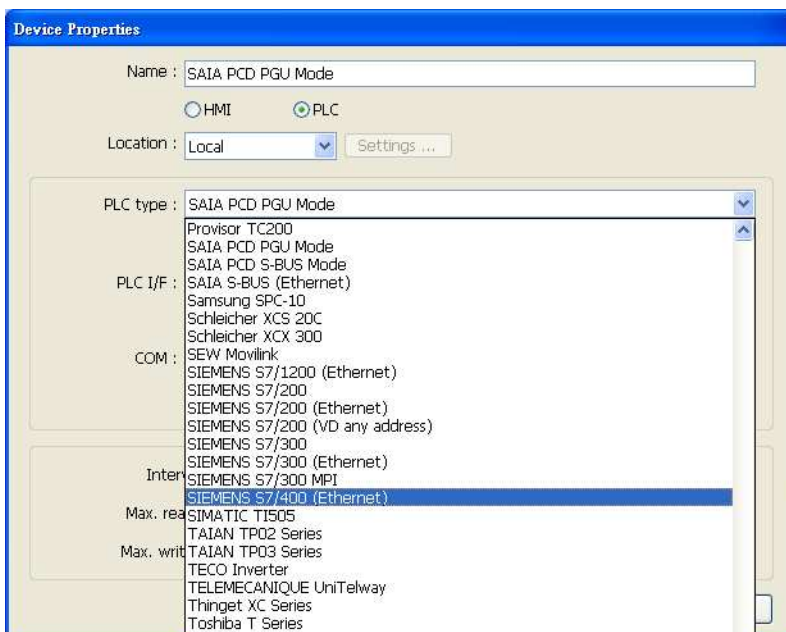

4. Press "Settings" button.

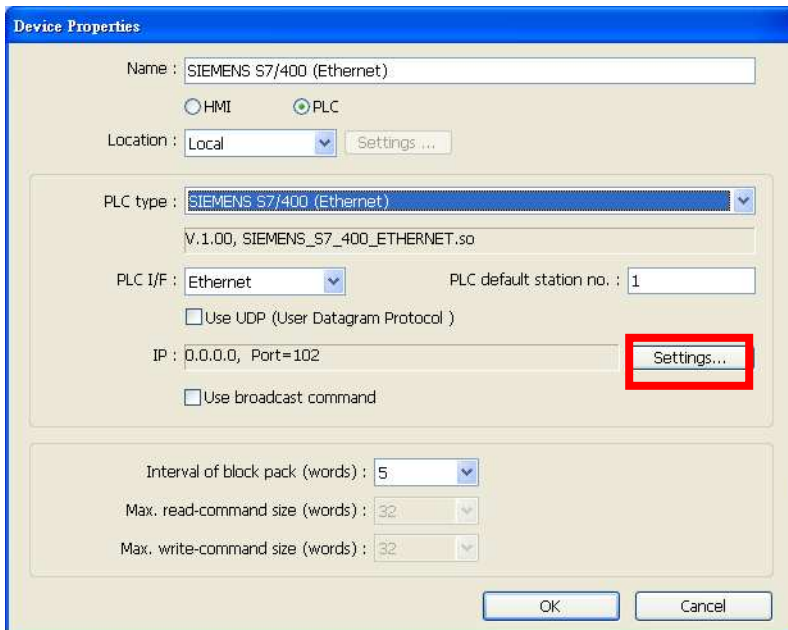

5. Setting S7/400 IP, Port, Link type, Rack and CPU slot. (have to match PLC)

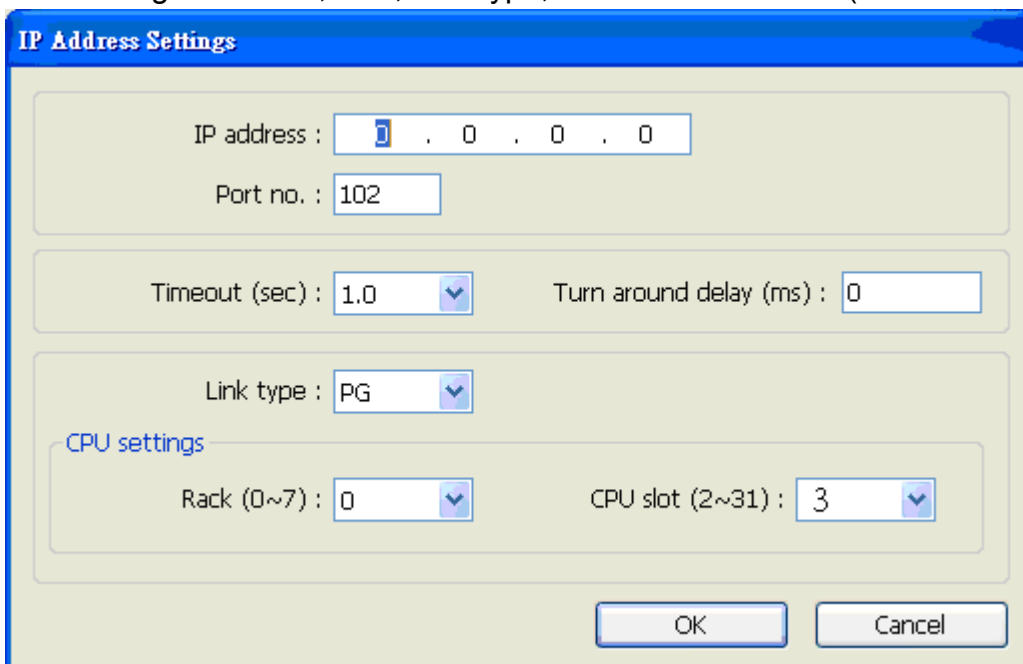

6. The setting will be finished as below,

Device Properties

Name :

HMI PLC

Location :

PLC type :

PLC I/F : PLC default station no. :

Use UDP (User Datagram Protocol)

IP :

Use broadcast command

Interval of block pack (words) :

Max. read-command size (words) :

Max. write-command size (words) :

Driver Version:

Version	Date	Description
V1.10	Dec/07/2010	

SIMATIC TI505

Supported series: SIMATIC TI505 Series PLCs: TI520, TI525, TI530, TI535, TI545, TI555, TI560, TI565, TI575. Using the NTP protocol in a point-to-point single master, single slave format.

Website: http://www.ad.siemens.de/simatic/controller/index_76.htm

HMI Setting:

Parameters	Recommend	Option	Notes
PLC type	SIMATIC TI505		NTP protocol
PLC I/F	RS232	RS232,	
Baud rate	19200	19200	
Parity	Odd	Odd	
Data bits	7	7	
Stop bits	1	1	
PLC st. no.	0	Does not apply	

Device Address:

Bit/Word	Device type	Format	Range	Memo
B	CR	DDDDD	1 ~ 65535	Internal Relay
B	X	DDDDD	1 ~ 65535	Discrete input coils
B	Y	DDDDD	1 ~ 65535	Discrete output coils
W	V	DDDDD	1 ~ 65535	User data registers
W	STW	DDDDD	1 ~ 65535	Status word registers
W	TCP	DDDDD	1 ~ 65535	Timer/counter preset values
W	TCC	DDDDD	1 ~ 65535	Timer/counter current values
W	WX	DDDDD	1 ~ 65535	Word discrete inputs
W	WY	DDDDD	1 ~ 65535	Word discrete outputs

Wiring Diagram:

9P D-Sub to 25P D-Sub:

HMI COM1 RS232 9P D-Sub Male	HMI COM2 RS232 9P D-Sub Male	HMI COM3 RS232 9P D-Sub Female	SIMATIC TI505 RS232 25P D-Sub	
2 RX	6 RX	8 RX	2 TXD	
3 TX	4 TX	7 TX	3 RXD	
5 GND	5 GND	5 GND	7 GND	
			4 RTS	circuit
			5 CTS	
			6 DSR	circuit
			8 DCD	
			20 DTR	
				

9P D-Sub to 9P D-Sub:

HMI COM1 RS232 9P D-Sub Male	HMI COM2 RS232 9P D-Sub Male	HMI COM3 RS232 9P D-Sub Female	SIMATIC TI505 RS232 9P D-Sub	
2 RX	6 RX	8 RX	3 TXD	
3 TX	4 TX	7 TX	2 RXD	
5 GND	5 GND	5 GND	5 GND	
			7 RTS	circuit
			8 CTS	
			1 DCD	circuit
			4 DTR	
			6 DSR	
				

9P D-Sub to 9P D-Sub:

HMI COM1 RS485 4W 9P D-Sub Female			SIMATIC TI505 RS422 9P D-Sub
1 RX-			7 DO (-)
2 RX+			1 DO (+)
3 TX-			8 DI (-)
4 TX+			5 DI (+)
5 GND			6 GND

Driver Version:

Version	Date	Description
V1.10	Apr/22/2009	

TAIAN TP02 Series

Supported series: TAIAN TP02 series.

Website: <http://www.taian-technology.com>

HMI Setting:

Parameters	Recommend	Option	Notes
PLC type	TAIAN TP02 Series		
PLC I/F	RS485 4W/2W	RS485 4W/2W	MMI 422 port: 4W; RS485 terminals: 2W
Baud rate	19200	9600, 19200, 38400	
Parity	Even	Even, Odd, None	
Data bits	7	7, 8	
Stop bits	2	1, 2	
PLC st. no.	1	0-255	

PLC Setting:

RS422 port: WS041=120, WS042=1;

RS485 terminals: WS044=120, WS045=1.

Device Address:

Bit/Word	Device type	Format	Range	Memo
B	X	DDD	1 ~ 384	Input relay
B	Y	DDD	1 ~ 384	Output relay
B	C	DDDD	1 ~ 2048	Auxiliary relay
W	X	DDD	1 ~ 369	Input register (must be 1 or a multiple of plus 1)
W	Y	DDD	1 ~ 369	Output register(must be 1 or a multiple of plus 1)
W	V	DDDD	1 ~ 1024	Auxiliary register
W	D	DDDD	1 ~ 2048	Auxiliary register
W	WS	DDD	1 ~ 128	System register
W	C	DDDD	1 ~ 2033	Auxiliary relay register(must be 1 or a

Bit/Word	Device type	Format	Range	Memo
				multiple of plus 1)
W	WC	DDD	1 ~ 912	Constant register

Wiring Diagram:

9P D-Sub to 9P D-Sub: TP02 Series MMI RS422 port

HMI COM1 RS485 4W 9P D-Sub Female			TP02 Series PLC CPU RS422 9P D-Sub
1 RX-			8 TX-
2 RX+			3 TX+
3 TX-			7 RX-
4 TX+			2 RX+
5 GND			



9P D-Sub to 9P D-Sub: TP02 Series RS485 Terminals

HMI COM1 RS485 2W 9P D-Sub Female	HMI COM3 RS485 2W 9P D-Sub Female		TP02 series PLC RS485 Terminals
1 RX-	6 Data-		T/R-
2 RX+	9 Data+		T/R+
5 GND	5 GND		



Driver Version:

Version	Date	Description
V1.10	Jan/25/2010	

TAIAN TP03 Series

Supported series: TECO (TAIAN TP03) series PLC.

Website: <http://www.teco.com.tw/sa/en/>

HMI Setting:

Parameters	Recommend	Option	Notes
PLC type	TAIAN TP03 Series		
PLC I/F	RS485 4W		
Baud rate	19200	9600, 19200	
Parity	None	Even, Odd, None	
Data bits	8	8	
Stop bits	2	1	
PLC st. no.	1	1-31	

Device Address:

Bit/Word	Device type	Format	Range	Memo
B	C	DDDD	0 ~ 9999	
B	M	DDDD	0 ~ 9999	
B	S	DDDD	0 ~ 9999	
B	T	DDDD	0 ~ 9999	
B	X	OOO	0 ~ 377	
B	Y	OOO	0 ~ 377	
W	D	DDDD	0 ~ 9999	
W	V	DDDD	0 ~ 9999	
W	Z	DDDD	0 ~ 9999	
W	T_Curent	DDDD	0 ~ 9999	
W	C_Curent	DDDD	0 ~ 9999	
W	T_Preset	DDDD	0 ~ 9999	
W	C_Preset	DDDD	0 ~ 9999	

Wiring Diagram:

9P D-Sub to 8P Mini-DIN:

HMI COM1 RS485 4W 9P D-Sub Female			TP03 PC/PDA Port RS422 8P Mini-DIN
1 RX-			4 TX-
2 RX+			7 TX+
3 TX-			1 RX-
4 TX+			2 RX+
5 GND			3 GND



Driver Version:

Version	Date	Description
V1.10	Nov/13/2009	

TECO Inverter

Supported series: TECO Inverter series, 7300CV model.

HMI Setting:

Parameters	Recommend	Option	Notes
PLC type	TECO Inverter		
PLC I/F	RS232	RS232/RS485	
Baud rate	38400		
Parity	None		
Data bits	8		
Stop bits	1		
PLC st. no.	1		

Device Address:

Bit/Word	Device type	Format	Range	Memo
B	0x	DDDDD	1 ~ 65535	Output bit
B	1x	DDDDD	1 ~ 65535	Input bit (read only)
B	3x_Bit	DDDDDdd	100 ~ 6553515	Input Register bit (read only)
B	4x_Bit	DDDDDdd	100 ~ 6553515	Output Register bit
B	6x_Bit	DDDDDdd	100 ~ 6553515	
B	0x (0x0f)	DDDDD	1 ~ 65535	Write Multiple Coils
W	3x	DDDDD	1 ~ 65535	Input Register (read only)
W	4x	DDDDD	1 ~ 65535	Output Register
DW	5x	DDDDD	1 ~ 65535	4x double word swap
W	6x	DDDDD	1 ~ 65535	4x single word write

Wiring Diagram:



MT8000



JNSIF-232



JNSIF-232Wiring Diagram:

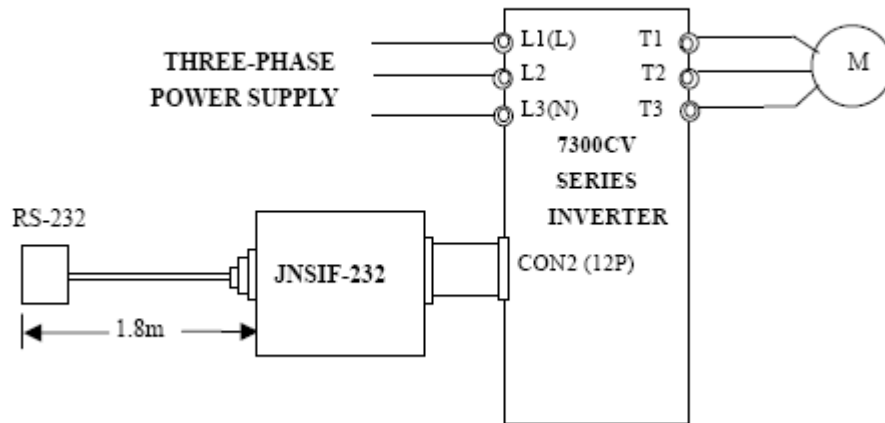

9P D-Sub to 9P D-Sub:

HMI COM1 RS232 9P D-Sub Male			TECO Inverter RS232
2 RX			2 TX
3 TX			3 RX
5 GND			5 GND
7 RTS			7 VCC

The illustration shows a 9P D-Sub male connector on the left, connected to a 9P D-Sub female connector on the right via a cable. The female connector is shown in two views: one showing the front and one showing the back.

Driver Version:

Version	Date	Description
V1.00	Jul/27/2009	Driver released.

TELEMECANIQUE UniTelway

Supported series: Modicon TSX Micro&Nano&Neza series PLC.

Website: <http://www.modicon.com>

HMI Setting:

Parameters	Recommend	Option	Notes
PLC type	TELEMECANIQUE UniTelway		
PLC I/F	RS485 2W	RS232/RS485	
Baud rate	19200	9600~115200	
Parity	Odd	Even, Odd, None	
Data bits	8	7,8	Must set as 8 to this protocol
Stop bits	1	1, 2	
HMI st. no.	5	1-8	
PLC st. no.	0	0-3	

Online Simulator	YES	Extend address mode	YES
Broadcast command	NO		

PLC Setting:

Communication mode	UniTelWay protocol, set PLC as master
--------------------	---------------------------------------

Device Address:

Bit/Word	Device type	Format	Range	Memo
B	S	DDDDD	0 ~ 32767	Internal relay
B	M	DDDDD	0 ~ 32767	Auxiliary relay
B	MW.B	DDDDDdd	0 ~ 3276715	Data register bit
W	MW	DDDDD	0 ~ 32767	Data register

Wiring Diagram:

9P D-Sub to 9P D-Sub: TSX37-XX/TSX07-XX CPU

HMI COM1 RS485 2W 9P D-Sub Female	HMI COM3 RS485 2W 9P D-Sub Female		TSX Series CPU Port RS485 2W 8P Mini-DIN
1 RX-	6 Data-		2 D-
2 RX+	9 Data+		1 D+
5 GND	5 GND		7 GND



Driver Version:

Version	Date	Description
V1.30	Sep/24/2009	

Topvert

Supported series: TOPVERT G1/H1/P1 series.

Website: <http://www.toptek.biz/>

HMI Setting:

Parameters	Recommend	Option	Notes
PLC type	Topvert		
Com port	RS485 2W		
Baud rate	9600		
Parity	None		
Data bits	7		
Stop bits	2		
PLC st. no.	1		

Online Simulator	YES	Broadcast command	YES
Extend address mode	YES	Broadcast station no.	0

PLC Setting:

Communication mode	Pr 7-15 = 0 (7, N, 2 ASCII)
--------------------	-----------------------------

Device Address:

Bit/Word	Device type	Format	Range	Memo
B	PR_Bit	DDDDdd	0 ~ 6553515	G=Groups, F=Function no. dd=0~15 bit no.
W	PR	DDDD	0 ~ 65535	G=Groups, F=Function no.

Note:

Max.read-command size (words): 16

Max.write-command size (words): 1

For G1/H1/P1 Series Inverter, if standard parameter address is in decimal= $100 \cdot G + F$:

G=Group (parameter group code 0~9); F=Function no. (parameter number 0~99)

For example: Pr5-20 (decimal Dec.) parameter address is expressed as $100 \cdot 5 + 20 = 520$.

Parameter (PrX-XX)	Address (decimal)
0-00	$0 \cdot 100 + 0 = 0$
0-14	$0 \cdot 100 + 14 = 14$
1-00	$1 \cdot 100 + 0 = 100$

Wiring Diagram:

9P D-Sub to 9P D-Sub:

HMI COM1 RS485 2W 9P D-Sub Female	HMI COM3 RS485 2W 9P D-Sub Female		TOPVERT RS485 2W
1 RX-	6 Data-		SG-
2 RX+	9 Data+		SG+
5 GND	5 GND		



Driver Version:

Version	Date	Description
V1.00	Dec/08/2010	Driver released.

Toshiba T Series

Supported series: Toshiba T series, S2E.

Website: <http://www.tic.toshiba.com>

HMI Setting:

Parameters	Recommend	Option	Notes
PLC type	Toshiba T Series		
PLC I/F	RS232	RS232/RS485	In accordance with plc port
Baud rate	9600	9600, 19200, 38400, 57600, 115200	
Parity	Odd	Even, Odd, None	
Data bits	8	7,8	
Stop bits	1	1, 2	
PLC st. no.	0	0-255	In accordance with PLC setting

Online Simulator	YES	Extend address mode	YES
------------------	-----	---------------------	-----

PLC Setting:

Communication mode	Must set PLC node ID
--------------------	----------------------

Device Address:

Bit/Word	Device type	Format	Range	Memo
B	X	DDDDh	0 ~ 4095f	Input Bit
B	Y	DDDDh	0 ~ 4095f	Output Bit
B	R	DDDDh	0 ~ 8191f	Auxiliary Bit
B	S	DDDDh	0 ~ 4095f	Special Bit
B	L	DDDDh	0 ~ 4095f	
B	Z	DDDDh	0 ~ 8191f	
W	T	DDD	0 ~ 511	Timer Register
W	C	DDD	0 ~ 511	Counter Register
W	D	DDDD	0 ~ 8191	Data Memory

Bit/Word	Device type	Format	Range	Memo
W	SW	DDD	0 ~ 255	Special Register
W	XW	DDD	0 ~ 255	Input Register
W	YW	DDD	0 ~ 255	Output Register
W	RW	DDD	0 ~ 511	Auxiliary Register
W	LW	DDD	0 ~ 255	
W	W	DDDD	0 ~ 1023	
W	F	DDDD	0 ~ 8191	

Wiring Diagram:

9P D-Sub to 8P Mini-DIN:

HMI COM1 RS232 9P D-Sub Male	HMI COM2 RS232 9P D-Sub Male	HMI COM3 RS232 9P D-Sub Female	Toshiba T1 PRG Port RS232 8P Mini-DIN	
2 RX	6 RX	8 RX	6 TXD	
3 TX	4 TX	7 TX	8 RXD	
5 GND	5 GND	5 GND	5 GND	
			4 RTS	circuit
			7 CTS	
				

9P D-Sub to 9P D-Sub:

HMI COM1 RS232 9P D-Sub Male	HMI COM2 RS232 9P D-Sub Male	HMI COM3 RS232 9P D-Sub Female	Toshiba T2 PRG Port RS232 9P D-Sub	
2 RX	6 RX	8 RX	3 TXD	
3 TX	4 TX	7 TX	2 RXD	
5 GND	5 GND	5 GND	5 GND	
			7 RTS	circuit
			8 CTS	
				

9P D-Sub to 15P D-Sub:

HMI COM1 RS485 4W 9P D-Sub Female			Toshiba T2 LINK Port RS422 15P D-Sub	
1 RX-			11 TXB	
2 RX+			3 TXA	
3 TX-			10 RXB	
4 TX+			2 RXA	
5 GND			7 SG	
			5 RTSA	circuit
			4 CTSA	
			13 RTSB	circuit
			12 CTSB	
				

Driver Version:

Version	Date	Description
V1.00	Sep/15/2009	Driver released.

Toshiba TC mini Series

Supported series: TOSHIBA MACHINE CO., JAPAN

WebSite: <http://www.toshiba-machine.co.jp>

HMI Setting:

Parameters	Recommend	Option	Notes
PLC type	Provisor TC200		
PLC I/F	RS232	RS232	In accordance with plc port
Baud rate	9600	9600, 19200	
Parity bit	None	Even, Odd, None	
Data Bits	8	7,8	
Stop Bits	1	1, 2	

Device Address:

Bit/Word	Device type	Format	Range	Memo
B	X_Bit	hhh(h)	0-fff(f)	(h) : Bit no.(0~f)
B	Y_Bit	hhh(h)	0-fff(f)	(h) : Bit no.(0~f)
B	R_Bit	hhh(h)	0-fff(f)	(h) : Bit no.(0~f)
B	L_Bit	hhh(h)	0-fff(f)	(h) : Bit no.(0~f)
W	V	hhh	0-fff	
W	P	hhh	0-fff	
W	D	hhh	0-fff	
W	R	hhh	0-fff	
W	L	hhh	0-fff	

Wiring Diagram:

9P D-Sub to 9P D-Sub:

HMI COM1 RS232 9P D-Sub Male	HMI COM2 RS232 9P D-Sub Male	HMI COM3 RS232 9P D-Sub Female	TC mini series RS232 9P D-Sub	
2 RX	6 RX	8 RX	2 TXD	
3 TX	4 TX	7 TX	3 RXD	
5 GND	5 GND	5 GND	5 GND	
			7 RTS	circuit
			9 CTS	
				

Toshiba VF-S11

Supported series: Toshiba Invertor Protocol (ASCII code).

HMI Setting:

Parameters	Recommend	Option	Notes
PLC type	Toshiba VF-S11		
PLC I/F	RS485 2W	RS422, RS485	
Baud rate	9600	9600, 19200	
Parity	Even	Even, Odd, None	
Data bits	8	7 or 8	
Stop bits	1	1 or 2	
PLC st. no.	0	0-99	

Online Simulator	YES	Extend address mode	YES
Broadcast command	YES		

Device Address:

Bit/Word	Device type	Format	Range	Memo
B	Cmd. No B	HHHHdd	0 ~ 270f15	
W	Cmd. No	HHHH	0 ~ ffff	Parameters and data memory

Wiring Diagram:

Pay Attention:

Before you connect the VF-S11, make sure you to put both switches of SW1 to the related position. (SW1: Wiring method selector switch)

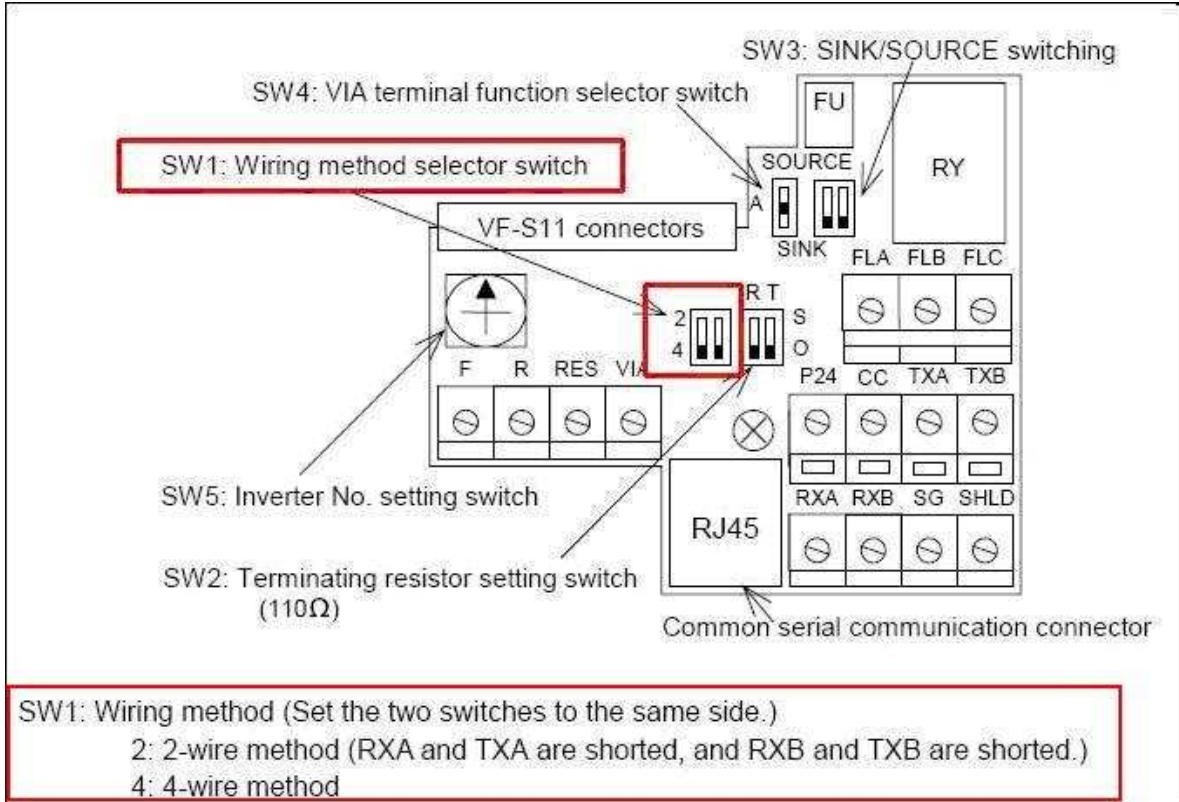

RS-485

9P D-Sub to 8P RJ45:

HMI COM1 RS485 2W 9P D-Sub Female	HMI COM3 RS485 2W 9P D-Sub Female		Toshiba VFFS1-VFPS1 RS485 2W 8P RJ45
1 RX-	6 Data-		5
2 RX+	9 Data+		4
5 GND	5 GND		8

Driver Version:

Version	Date	Description
V1.20	Aug/31/2009	

VIGOR

Supported series: VIGOR M Series.

Website: <http://www.vigorplc.com.tw/>

HMI Setting:

Parameters	Recommend	Option	Notes
PLC type	VIGOR		
PLC I/F	RS232	RS232, RS485 4wires,	
Baud rate	19200		
Parity	Even		
Data bits	7		
Stop bits	1		
PLC st. no.	1		

Device Address:

Bit/Word	Device type	Format	Range	Memo
B	X	OOO	0 ~ 377	
B	Y	OOO	0 ~ 377	
B	M	DDDD	0 ~ 7999	
B	SM	DDDD	9000 ~ 9255	
B	T	DDD	0 ~ 255	
B	C	DDD	0 ~ 255	
W	TV	DDD	0 ~ 255	
W	CV	DDD	0 ~ 199	
W	D	DDDD	0 ~ 9255	
W	CV2	DDD	200 ~ 255	
W	SD	DDDD	9000 ~ 9255	

Wiring Diagram:

9P D-Sub to 6P Terminals:

HMI COM1 RS485 4W 9P D-Sub Female			Vigor M series 6P Terminals
1 RX-			TX-
2 RX+			TX+
3 TX-			RX-
4 TX+			RX+
5 GND			SG
			24V

9P D-Sub to 9P D-Sub:

HMI COM1 RS232 9P D-Sub Male	HMI COM2 RS232 9P D-Sub Male	HMI COM3 RS232 9P D-Sub Female	Vigor M series COM Port
2 RX	6 RX	8 RX	3 TXD
3 TX	4 TX	7 TX	2 RXD
5 GND	5 GND	5 GND	5 GND
			

Driver Version:

Version	Date	Description
V1.10	Dec/30/2008	

YAMAHA ERCD

HMI Setting:

Parameters	Recommend	Option	Notes
PLC type	YAMAHA ERCD		
PLC I/F	RS232		
Data bits	8	7 or 8	
Stop bits	1	1 or 2	
Baud rate	9600	1200-19200	
Parity	Odd	None/Even/Odd	
PLC st. no.	0		Do not need to set the station No.

Device Address:

Bit/Word	Device type	Format	Range	Memo
Word	P	DDD	0 ~ 999	Read/Write, PNT point data
Word	SWI	D	0	Write only , RW0=program number , Switches program number to be run
Word	ORG	D	0	Write only , Returns to origin
Word	RESET	D	0	Write only , Reset program
Word	RUN	D	0	Write only , Starts automatic operation
Word	MOVD	D	0	Write only , Directly moves to specified position RW1=X-axis position(mm), RW2=speed
Word	X_ADD	D	0	Write only , X + command
Word	X_SUB	D	0	Write only , X - command

Wiring Diagram:

9P D-Sub to 9P D-Sub:

HMI COM1 RS232 9P D-Sub Male	HMI COM2 RS232 9P D-Sub Male	HMI COM3 RS232 9P D-Sub Female	PB RS232	
2 RX	6 RX	8 RX	3 TX	
3 TX	4 TX	7 TX	2 RX	
5 GND	5 GND	5 GND	5 GND	
			7 RTS	circuit
			8 CTS	
				

Driver Version:

Version	Date	Description
V1.30	Jan/04/2010	

YASKAWA MP Series Ethernet (Extension)

HMI Setting:

Parameters	Recommend	Option	Notes
PLC type	YASKAWA MP Series Ethernet (Extension)		
PLC I/F	Ethernet (UDP)		
PLC st. no.	1		
Port no.	10000		

PLC Setting:

Yaskawa PLC Communication Parameter Settings

(1) PLC Factory Communication Parameter Settings:

Item	Set
IP Address	192.168.1.1
Subnet Mask	255.255.255.0
Gateway IP Address	0.0.0.0
System Port No.	10000 (UDP)
TCP Zero Window Timer Value	3 (s)
TCP Retry Time	500 (ms)
TCP Close Time	60 (s)
IP Assemble Time	30 (s)
Max. Packet Length	1500 (bytes)

(2) Setting Steps:

1. Set IP for PLC.

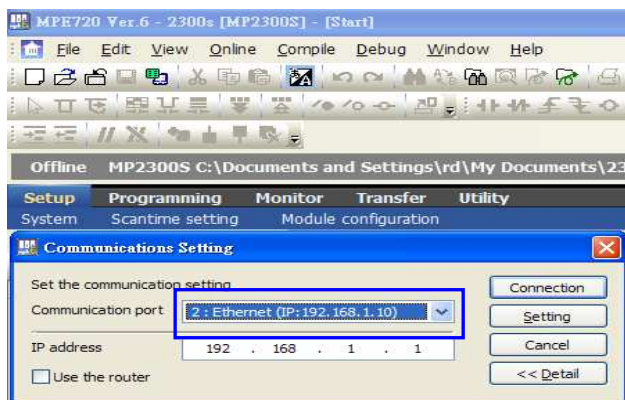

2. Communication parameter setting.

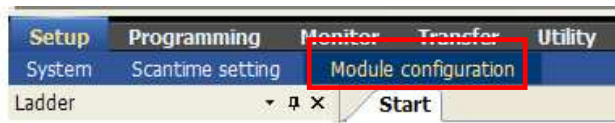

3. Go to Module Details and select 218IFA for setting relevant parameters for Ethernet transmission.

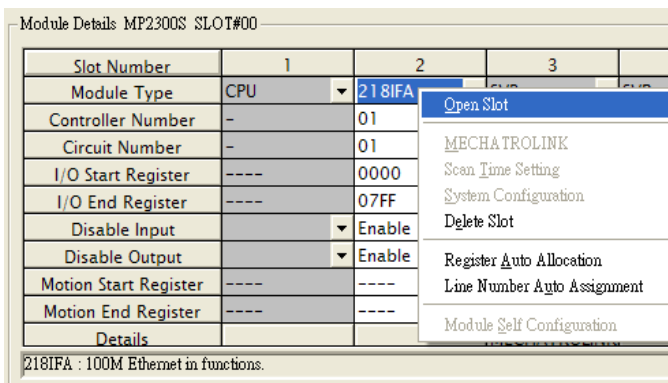

4. The settings are shown below, PLC IP can't be repeated.

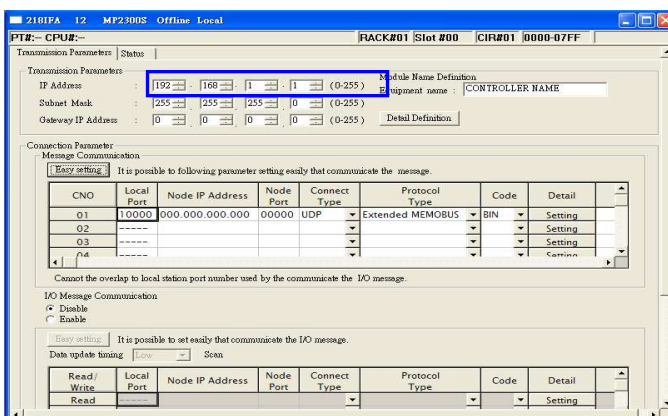

5. Download PLC communication parameters to PLC, and restart the controller.



(3) HMI Settings:

1. Select Ethernet for PLC I/F.
2. Tick UDP.
3. Set PLC IP and Port, the default Port is 10000.

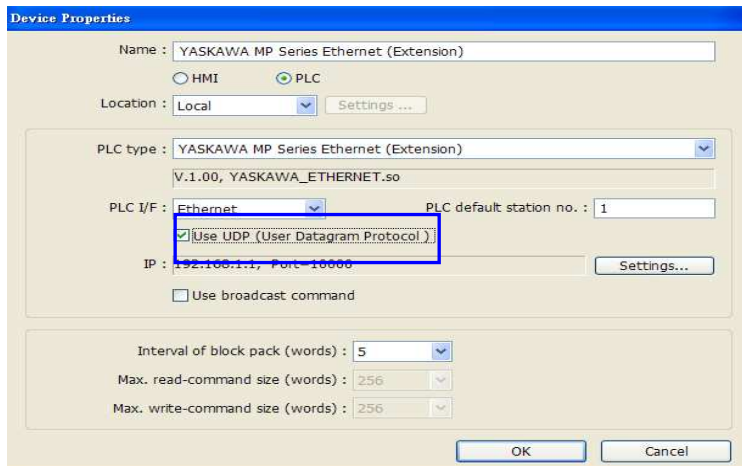

Device Address:

Bit/Word	Device type	Format	Range	Memo
B	IB	HHHHh	0 ~ ffff	
B	OB	HHHHh	0 ~ ffff	
B	MB	DDDDh	0 ~ 65534f	
B	SB	DDDDh	0 ~ 8191f	
W	IW	HHHH	0 ~ ffff	
W	OW	HHHH	0 ~ ffff	
W	MW	DDDD	0 ~ 65534	
W	SW	DDDD	0 ~ 8191	

Wiring Diagram:

Direct connect (crossover cable):

HMI RJ45 Female	Wire Color	PLC RJ45 Female
1 TX+	White/Orange	3 RX+
2 TX-	Orange	6 RX-
3 RX+	White/Green	1 TX+
4 BD4+	Blue	4 BD4+

5 BD4-	White/Blue	5 BD4-
6 RX-	Green	2 TX-
7 BD3+	White/Brown	7 BD3+
8 BD3-	Brown	8 BD3-



Through a hub:

HMI RJ45 Female	Wire Color	PLC RJ45 Female
1 TX+	White/Orange	1 TX+
2 TX-	Orange	2 TX-
3 RX+	White/Green	3 RX+
4 BD4+	Blue	4 BD4+
5 BD4-	White/Blue	5 BD4-
6 RX-	Green	6 RX-
7 BD3+	White/Brown	7 BD3+
8 BD3-	Brown	8 BD3-



Driver Version:

Version	Date	Description
V1.00	Dec/28/2010	Driver released.

YASKAWA SMC 3010

Supported series: YASKAWA SMC Series Servo Motor Controller.

HMI Setting:

Parameters	Recommend	Option	Notes
Device type	YASKAWA SMC 3010		
PLC I/F	RS232		
Baud rate	19200	9600, 19200	
Parity	None		
Data bits	8		
Stop bits	1		

Device Address:

Bit/Word	Device type	Format	Range	Memo
B	AF	D	0 ~ 1	
B	BN	D	0 ~ 1	Write only
B	BP	D	0 ~ 1	Write only
B	BV	D	0 ~ 1	Write only
B	CB	DDDD	0 ~ 9999	Write only
B	CM	D	0 ~ 1	Read only
B	DV	D	0 ~ 1	
B	EB	D	0 ~ 1	
B	OE	D	0 ~ 1	
B	RS	D	0 ~ 1	Write only
B	ST	D	0 ~ 1	Write only
B	TB	Do	0 ~ 17	Read only
B	V_Bit	DDDdd	0 ~ 99931	*2
B	D_arr_Bit	DDDdd	0 ~ 99931	
DW	AC	D	0 ~ 4	
DW	DC	D	0 ~ 4	
DW	BL	D	0 ~ 4	
W	CD	D	0 ~ 2	Write only
W	CE	D	0 ~ 2	
DW	DE	D	0 ~ 4	

Bit/Word	Device type	Format	Range	Memo
DW	DP	D	0 ~ 4	
W	DT	D	0 ~ 2	
W	EC	D	0 ~ 2	
DW	EM	D	0 ~ 4	
W	ER	D	0 ~ 2	
W	FA	D	0 ~ 2	
DW	FL	D	0 ~ 4	
W	FV	D	0 ~ 2	
DW	GR	D	0 ~ 4	
DW	JG	D	0 ~ 4	
DW	MM	D	0 ~ 4	
W	MT	D	0 ~ 2	
W	NA	D	0 ~ 2	
W	OP	D	0 ~ 2	
DW	PA	D	0 ~ 4	Write only
DW	PR	D	0 ~ 4	
DW	SP	D	0 ~ 4	
W	TC	D	0 ~ 2	Read only
W	TM	D	0 ~ 2	
W	TW	D	0 ~ 2	
DW	VA	D	0 ~ 4	
DW	VD	D	0 ~ 4	
DW	VS	D	0 ~ 4	
DW	IL	D	0 ~ 4	
DW	IT	D	0 ~ 4	
DW	KD	D	0 ~ 4	
DW	KI	D	0 ~ 4	
DW	KP	D	0 ~ 4	
DW	OF	D	0 ~ 4	
DW	TL	D	0 ~ 4	
DW	VR	D	0 ~ 4	
DW	VT	D	0 ~ 4	
DW	PF	D	0 ~ 4	*1
DW	VF	D	0 ~ 4	
DW	V	DDD	0 ~ 999	*2
F	F	DDD	0 ~ 999	*2
W	D_array	DDD	0 ~ 999	

Bit/Word	Device type	Format	Range	Memo
W	R_array	DDD	0 ~ 999	

Note:

*1 PF is the communication parameter of SMC_3010, default is 10.4, if the value is not 10.4, all values will be displayed incorrect.

*2 User define integer variable V000~V999, floating point variable F000~F999.

Wiring Diagram:

9P D-Sub to 9P D-Sub:

HMI COM1 RS232 9P D-Sub Male	HMI COM2 RS232 9P D-Sub Male	HMI COM3 RS232 9P D-Sub Female	SMC3010 CN6 RS232 9P D-Sub	
2 RX	6 RX	8 RX	2 TXD	
3 TX	4 TX	7 TX	3 RXD	
5 GND	5 GND	5 GND	5 GND	
			7 RTS	circuit
			8 CTS	



Driver Version:

Version	Date	Description
V1.30	Mar/29/2010	

YASKAWA SMC 3010 (Ethernet)

Supported series: YASKAWA SMC Series Servo Motor Controller.

HMI Setting:

Parameters	Recommend	Option	Notes
Device type	YASKAWA SMC 3010 (Ethernet)		
PLC I/F	Ethernet		
Port no.	23		

Device Address:

Bit/Word	Device type	Format	Range	Memo
B	AF	D	0 ~ 1	
B	BN	D	0 ~ 1	Write only
B	BP	D	0 ~ 1	Write only
B	BV	D	0 ~ 1	Write only
B	CB	DDDD	0 ~ 9999	Write only
B	CM	D	0 ~ 1	Read only
B	DV	D	0 ~ 1	
B	EB	D	0 ~ 1	
B	OE	D	0 ~ 1	
B	RS	D	0 ~ 1	Write only
B	ST	D	0 ~ 1	Write only
B	TB	Do	0 ~ 17	Read only
B	V_Bit	DDDdd	0 ~ 99931	*2
B	D_arr_Bit	DDDdd	0 ~ 99931	
DW	AC	D	0 ~ 4	
DW	DC	D	0 ~ 4	
DW	BL	D	0 ~ 4	
W	CD	D	0 ~ 2	Write only
W	CE	D	0 ~ 2	
DW	DE	D	0 ~ 4	
DW	DP	D	0 ~ 4	
W	DT	D	0 ~ 2	
W	EC	D	0 ~ 2	

Bit/Word	Device type	Format	Range	Memo
DW	EM	D	0 ~ 4	
W	ER	D	0 ~ 2	
W	FA	D	0 ~ 2	
DW	FL	D	0 ~ 4	
W	FV	D	0 ~ 2	
DW	GR	D	0 ~ 4	
DW	JG	D	0 ~ 4	
DW	MM	D	0 ~ 4	
W	MT	D	0 ~ 2	
W	NA	D	0 ~ 2	
W	OP	D	0 ~ 2	
DW	PA	D	0 ~ 4	Write only
DW	PR	D	0 ~ 4	
DW	SP	D	0 ~ 4	
W	TC	D	0 ~ 2	Read only
W	TM	D	0 ~ 2	
W	TW	D	0 ~ 2	
DW	VA	D	0 ~ 4	
DW	VD	D	0 ~ 4	
DW	VS	D	0 ~ 4	
DW	IL	D	0 ~ 4	
DW	IT	D	0 ~ 4	
DW	KD	D	0 ~ 4	
DW	KI	D	0 ~ 4	
DW	KP	D	0 ~ 4	
DW	OF	D	0 ~ 4	
DW	TL	D	0 ~ 4	
DW	VR	D	0 ~ 4	
DW	VT	D	0 ~ 4	
DW	PF	D	0 ~ 4	*1
DW	VF	D	0 ~ 4	
DW	V	DDD	0 ~ 999	*2
F	F	DDD	0 ~ 999	*2
W	D_array	DDD	0 ~ 999	
W	R_array	DDD	0 ~ 999	

Note:

*1 PF is the communication parameter of SMC_3010, default is 10.4, if the value is not 10.4, all values will be displayed incorrect.

*2 User define integer variable V000~V999, floating point variable F000~F999.

Wiring Diagram:

Direct connect (crossover cable):

HMI RJ45 Female	Wire Color	PLC RJ45 Female
1 TX+	White/Orange	3 RX+
2 TX-	Orange	6 RX-
3 RX+	White/Green	1 TX+
4 BD4+	Blue	4 BD4+
5 BD4-	White/Blue	5 BD4-
6 RX-	Green	2 TX-
7 BD3+	White/Brown	7 BD3+
8 BD3-	Brown	8 BD3-



Through a hub:

HMI RJ45 Female	Wire Color	PLC RJ45 Female
1 TX+	White/Orange	1 TX+
2 TX-	Orange	2 TX-
3 RX+	White/Green	3 RX+
4 BD4+	Blue	4 BD4+
5 BD4-	White/Blue	5 BD4-
6 RX-	Green	6 RX-
7 BD3+	White/Brown	7 BD3+
8 BD3-	Brown	8 BD3-



Driver Version:

Version	Date	Description
V1.10	Mar/29/2010	

Yokogawa FA-M3

Supported series : FA-M3 CPU SP35-5N, SP55-5N CPU port, F3LC11 Computer Link module.

Website : <http://www.yokogawa.com/itc/itc-index-en.htm>

HMI Setting:

Parameters	Recommend	Option	Notes
PLC type	Yokogawa FA-M3		
PLC I/F	RS232		
Baud rate	19200	9600, 19200	
Parity	Even	Even, Odd, None	
Data bits	8	8	
Stop bits	1	1	
PLC st. no.	1	1-31	

PLC Setting:

Communication mode	Use Personal Communication Link Use checksum Use End Character
--------------------	--

Device Address:

Bit/Word	Device type	Format	Range	Memo
B	X	DDDDD	0 ~ 71664	
B	Y	DDDDD	0 ~ 71664	
B	I	DDDDD	1 ~ 16384	
B	L	DDDD	1 ~ 9984	
B	M	DDDDD	0 ~ 71024	
W	D	DDDDD	1 ~ 16384	
W	B	DDDDD	1 ~ 32768	
W	V	DDD	1 ~ 256	
W	W	DDDDD	1 ~ 71024	

W	Z	DDDD	1 ~ 1024	
---	---	------	----------	--

Wiring Diagram:

9P D-Sub to 9P D-Sub:

HMI COM1 RS232 9P D-Sub Male	HMI COM2 RS232 9P D-Sub Male	HMI COM3 RS232 9P D-Sub Female	CPU Port Cable KM11 RS232
2 RX	6 RX	8 RX	2 TXD
3 TX	4 TX	7 TX	3 RXD
5 GND	5 GND	5 GND	5 GND



9P D-Sub to 9P D-Sub: LC11

HMI COM1 RS232 9P D-Sub Male	HMI COM2 RS232 9P D-Sub Male	HMI COM3 RS232 9P D-Sub Female	LC11 Computer Link Module RS232 Port
2 RX	6 RX	8 RX	3 TXD
3 TX	4 TX	7 TX	2 RXD
5 GND	5 GND	5 GND	5 GND
			7 RTS
			8 CTS
			circuit



How to get the WideField communication setting

If you want get the WideField communication setting, select [Tool]->[Set Environment] default is Automatic. Using the Automatic Recognition, Wide Field software will connect the Current PLC and get the PLC communication setting. If you have know the PLC communication configuration, you also can select the Fixed mode, It will connect the PLC quickly.

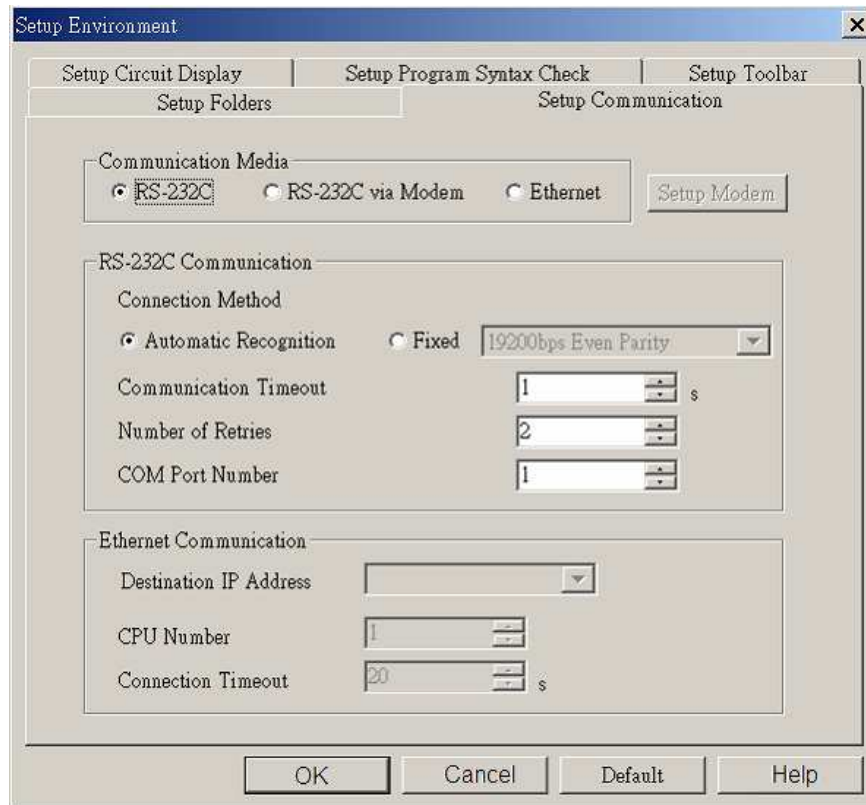

P.S Because use Personal computer link, when you connecting to PLC it will delay about 20sec for test communication.

How to Setting YOKOGAWA PLC Communcation

Configuration

YOKOGAWA FA-M3

CPU SP55-5N (same SP35-5N)

[File] -> [New Project] to create a new project

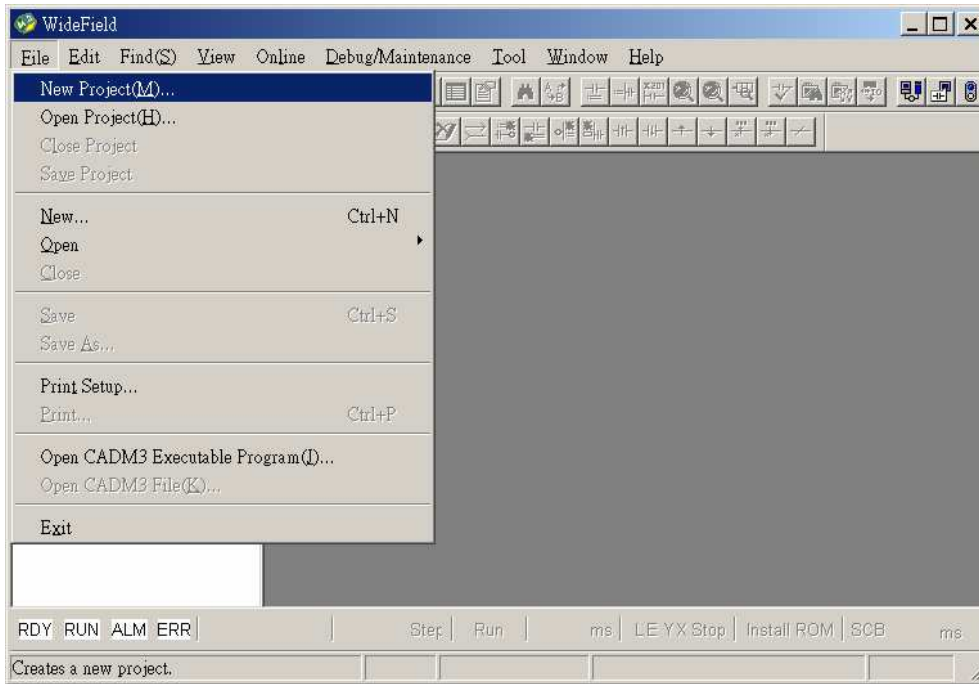

Click "Configuration" for setup communication.

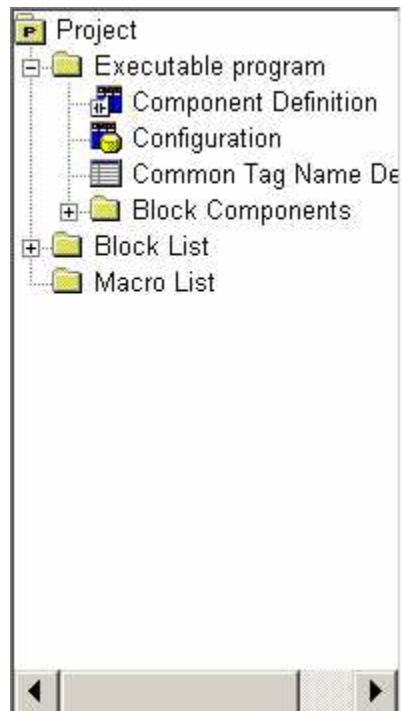

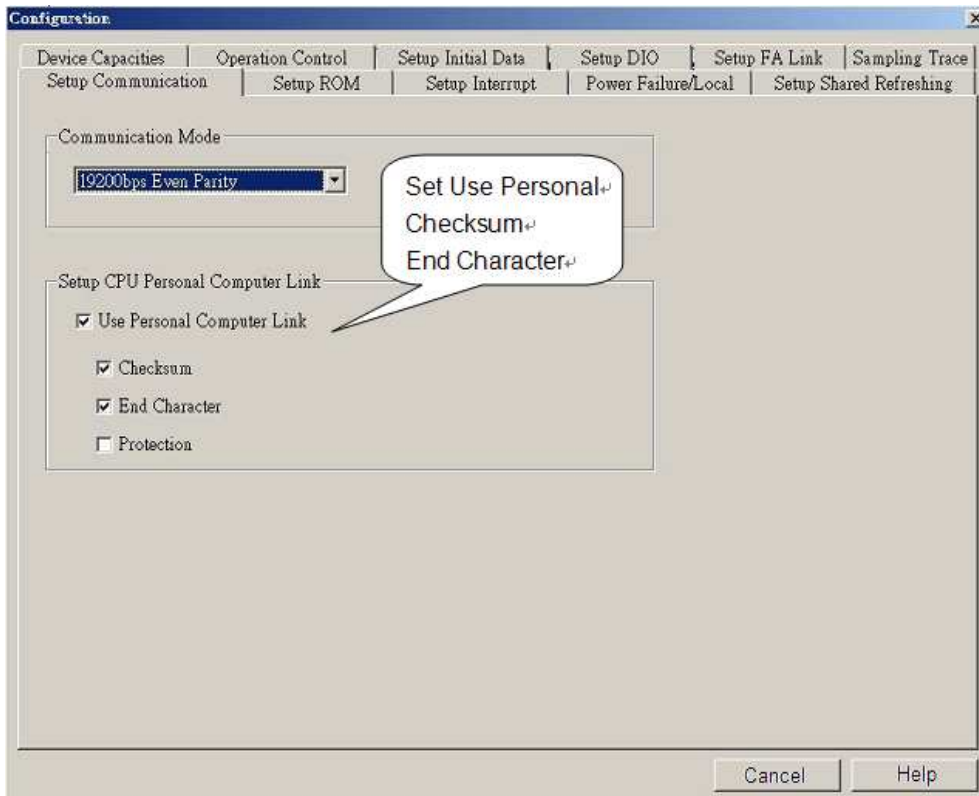
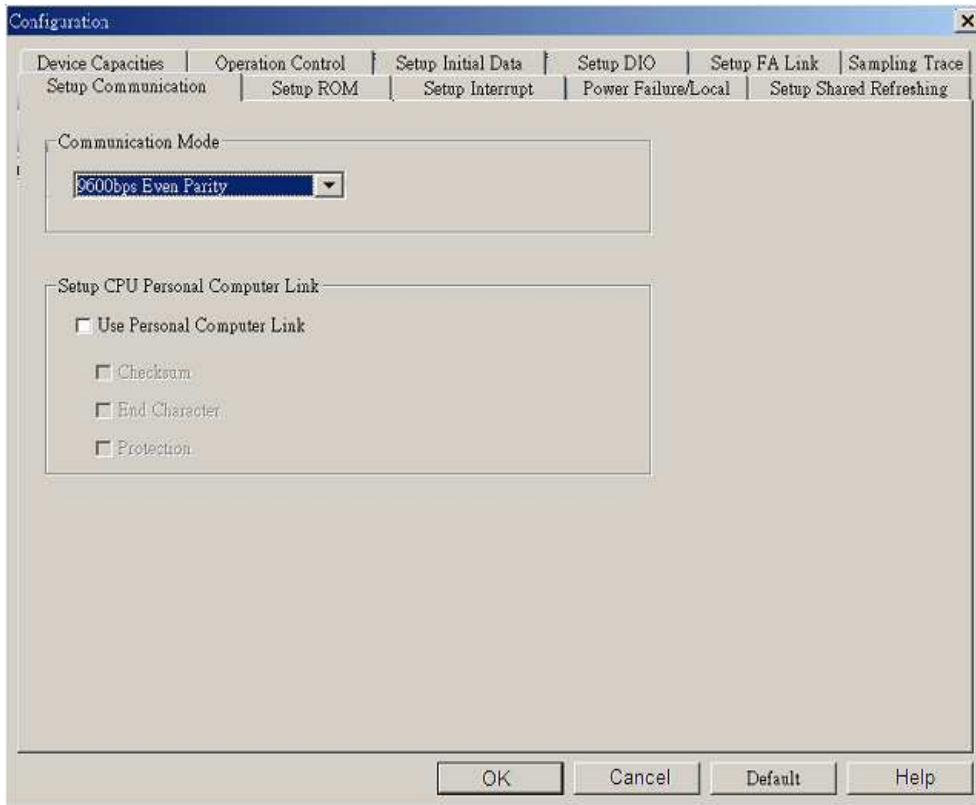

Driver Version:

Version	Date	Description
V1.20	Oct/23/2009	

Yokogawa FA-M3 (Ethernet)

Supported series : FA-M3 CPU SP35-5N, SP55-5N with F3LE01-5T/F3LE11-0T Ethernet module.

Website: <http://www.yokogawa.com/itc/itc-index-en.htm>

HMI Setting:

Parameters	Recommend	Option	Notes
PLC type	Yokogawa FA-M3 (Ethernet)		
PLC I/F	Ethernet		
Port No.	12289		
PLC st. no.	1		

PLC Setting:

Communication mode	Set IP Address, Set all condition setup switch to OFF.
--------------------	--

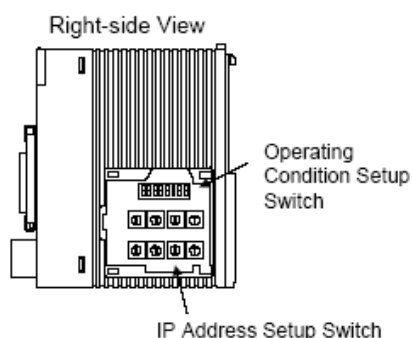

Example: Setting the IP address to 192.168.250.210

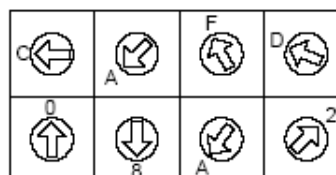

Hexa	C0	A8	FA	D2
decimal	↑	↑	↑	↑
Decimal	192	168	250	210

Device Address:

Bit/Word	Device type	Format	Range	Memo
B	X	DDDDD	0 ~ 71664	
B	Y	DDDDD	0 ~ 71664	
B	I	DDDDD	1 ~ 16384	
B	L	DDDD	1 ~ 9984	
B	M	DDDDD	0 ~ 71024	
W	D	DDDD	1 ~ 8192	
W	B	DDDDD	1 ~ 32768	
W	V	DD	1 ~ 64	
W	W	DDDDD	1 ~ 71024	

W	Z	DDD	1 ~ 512	
---	---	-----	---------	--

Wiring Diagram:

Direct connect (crossover cable):

HMI RJ45 Female	Wire Color	PLC RJ45 Female
1 TX+	White/Orange	3 RX+
2 TX-	Orange	6 RX-
3 RX+	White/Green	1 TX+
4 BD4+	Blue	4 BD4+
5 BD4-	White/Blue	5 BD4-
6 RX-	Green	2 TX-
7 BD3+	White/Brown	7 BD3+
8 BD3-	Brown	8 BD3-



Through a hub:

HMI RJ45 Female	Wire Color	PLC RJ45 Female
1 TX+	White/Orange	1 TX+
2 TX-	Orange	2 TX-
3 RX+	White/Green	3 RX+
4 BD4+	Blue	4 BD4+
5 BD4-	White/Blue	5 BD4-
6 RX-	Green	6 RX-
7 BD3+	White/Brown	7 BD3+
8 BD3-	Brown	8 BD3-



Driver Version:

Version	Date	Description
V1.00	Dec/30/2008	Driver released.

MT6050i/MT8050i Com Port Pin Assignment

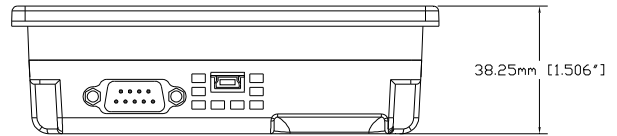

Bottom View

MT6050i/MT8050i

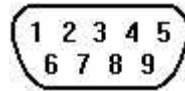

Pin assignment of the 9 Pin, Male,

Pin assignment of the 9 Pin, Male, SUB-D, COM1 [RS-232]/ [RS-485], COM3 [RS-485] Port. Only Com1[RS485 2W] support MPI 187.5K.

Pin#	Symbol	Com1[RS485]		Com1[RS232]	Com3[RS485]
		4 wire	2 wire		
1	Rx-	Rx-	Data-		
2	Rx+	Rx+	Data+		
3	Tx-	Tx-			
4	Tx+	Tx+			
5	GND	GND			
6	TxD			Transmit	
7	Data-				Data-
8	Data+				Data+
9	RxD			Receive	

Wiring Diagram:

MT6050i COM1 [RS-232]

9P D-SUB Female

9	RXD
6	TXD
5	GND

PLC RS-232

Communication Com Port interface

TXD
RXD
GND

MT6050i COM1 [RS-485 2w]

9P D-SUB Female

1	Data-
2	Data+

PLC RS-485 2w

Communication Com Port interface

Data-
Data+

MT6050i COM3* [RS-485 2w]

9P D-SUB Female

7	Data-
8	Data+

PLC RS-485 2w

Communication Com Port interface

Data-
Data+

*RS485 2W COM3 is only available for MT6050iv2

MT6050i COM1 [RS-485 4w]

9P D-SUB Female

1	RX-
2	RX
3	TX-
4	TX+

PLC RS-485 2w

Communication Com Port interface

TX-
TX+
RX-
RX+